



3X360R, 3X360G

Three Plane Lasers

Users Manual

09/2020

© 2020 Fluke Corporation. All rights reserved. Specifications are subject to change without notice.
All product names are trademarks of their respective companies.

LIMITED WARRANTY AND LIMITATION OF LIABILITY

This Fluke product will be free from defects in material and workmanship for three years from the date of purchase. This warranty does not cover fuses, disposable batteries, or damage from accident, neglect, misuse, alteration, contamination, or abnormal conditions of operation or handling. Resellers are not authorized to extend any other warranty on Fluke's behalf. To obtain service during the warranty period, contact your nearest Fluke authorized service center to obtain return authorization information, then send the product to that Service Center with a description of the problem.

THIS WARRANTY IS YOUR ONLY REMEDY. NO OTHER WARRANTIES, SUCH AS FITNESS FOR A PARTICULAR PURPOSE, ARE EXPRESSED OR IMPLIED. FLUKE IS NOT LIABLE FOR ANY SPECIAL, INDIRECT, INCIDENTAL OR CONSEQUENTIAL DAMAGES OR LOSSES, ARISING FROM ANY CAUSE OR THEORY. Since some states or countries do not allow the exclusion or limitation of an implied warranty or of incidental or consequential damages, this limitation of liability may not apply to you.

Fluke Corporation
P.O. Box 9090
Everett, WA 98206
U.S.A.

Fluke Europe B.V.
P.O. Box 1186
5602 BD Eindhoven
The Netherlands

ООО «Флюк СИАЙЭС»
125167, г. Москва,
Ленинградский проспект дом 37,
корпус 9, подъезд 4, 1 этаж

Table of Contents

Title	Page
Introduction	1
How to Contact Fluke	1
Safety Information	1
Product Familiarization	3
Features.....	3
Lasers and Optical Glass.....	4
Controls	5
Check Product Accuracy	6
Cone Accuracy.....	6
Horizontal Leveling Accuracy.....	8
Vertical Accuracy	10
90 Degree Accuracy	12
Accessories	14
3X360 Magnetic L-bracket.....	14
Maintenance	15
Clean the Product	15
Replacing Battery	15
RBP5 Rechargeable Battery.....	16
Housing Glass Insert	16
Specifications	17

Introduction

The 3X360R, 3X360G Three Plane Lasers (the Product) are battery powered, self-leveling, professional grade instruments. The 3X360R emit solid red line lasers. The 3X360G emit solid green line lasers. The 3X360R and 3X360G also emit vertical and horizontal point lasers 90 degrees from the Product. Use the Product to lay out reference points to align targets horizontally, vertically, or diagonally.

Note

If the laser beam is difficult to see, use either the XLD+ or SLDR or SLDG Laser Detector to accurately determine the location of the laser. See the XLD+ or SLDR or SLDG Users Manual.

How to Contact Fluke

To contact Fluke, call one of the following telephone numbers:

- Technical Support USA: 1-800-44-FLUKE (1-800-443-5853)
- Calibration/Repair USA: 1-888-99-FLUKE (1-888-993-5853)
- Canada: 1-800-36-FLUKE (1-800-363-5853)
- Europe: +31 402-675-200
- Japan: +81-3-6714-3114
- Singapore: +65-6799-5566
- China: +86-400-921-0835
- Brazil: +55-11-3530-8901
- Anywhere in the world: +1-425-446-5500

Or, visit the PLS website at www.plslaser.com.

To view, print, or download the latest manual supplement, visit www.plslaser.com.

Safety Information

A Warning identifies conditions and procedures that are dangerous to the user. A Caution identifies conditions and procedures that can cause damage to the Product or the equipment under test.









⚠ ⚠ Warning

To prevent eye damage and personal injury:

- Read all safety information before you use the Product.
- Carefully read all instructions.
- Do not alter the Product and use only as specified, or the protection supplied by the Product can be compromised.
- Do not use the Product if it operates incorrectly.
- Do not use the Product if it is altered or damaged.
- Use the Product only as specified or hazardous laser radiation exposure can occur.
- Do not look into the laser. Do not point laser directly at persons or animals or indirectly off reflective surfaces.
- Do not look directly into the laser with optical tools (for example, binoculars, telescopes, microscopes). Optical tools can focus the laser and be dangerous to the eye.
- Do not open the Product. The laser beam is dangerous to eyes.
- Battery contains hazardous chemicals that can cause burns or explode. If exposure to chemicals occurs, clean with water and get medical aid.
- Do not disassemble the battery.
- Repair the Product before use if the battery leaks.
- The battery door must be closed and locked before you operate the Product.
- Remove the battery if the Product is not used for an extended period of time, or if stored in temperatures above 50 °C. If the battery is not removed, battery leakage can damage the Product.
- Replace the battery when the low battery indicator shows to prevent incorrect measurements.
- Use only Fluke approved power adapters to charge the battery. Refer to RBP5 manual for additional safety information and instructions.
- Do not short the battery terminals together.
- Do not disassemble or crush battery cells and battery packs.
- Do not keep cells or battery in a container where the terminals can be shorted.
- Do not put battery cells and battery packs near heat or fire. Do not put in sunlight.

Table 1 is a list of the symbols that can be used on the Product or in this manual.

Table 1. Symbols

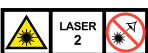
Symbol	Description	Symbol	Description
	Consult user documentation.		Conforms to European Union directives.
	WARNING. RISK OF DANGER.		Conforms to relevant Australian Safety and EMC standards.
	WARNING. LASER RADIATION. Risk of eye damage.		Conforms to relevant South Korean EMC Standards.
	Battery		Low battery indicator.
	This product complies with the WEEE Directive marking requirements. The affixed label indicates that you must not discard this electrical/electronic product in domestic household waste. Product Category: With reference to the equipment types in the WEEE Directive Annex I, this product is classed as category 9 “Monitoring and Control Instrumentation” product. Do not dispose of this product as unsorted municipal waste.		
	Indicates a Class 2 laser. DO NOT STARE INTO BEAM The following text may appear with the symbol on the product label: “IEC/EN 60825-1:2014. Complies with 21 CFR 1040.10 and 1040.11 except for conformance with IEC 60825-1 Ed.3., as described in Laser Notice No.56, dated May 8, 2019.” In addition, the following pattern on the label will indicate wavelength and optical power: $\lambda = 635 \text{ nm RED}$ or $\lambda = 520 \text{ nm GREEN}$, $< 1 \text{ mW}$.		

Note

In colder climates, the Product needs sufficient time to warm up to achieve the stated accuracy measurements. Turn on both the horizontal and vertical lasers and wait 3 minutes before you take a measurement. When you move the Product between environments with large differences in ambient temperature, allow for an additional adjustment time.

Product Familiarization

The manual explains features for multiple models. Because models have different features and accessories, not all of the information in the manual may apply to your Product.

Features

Use Table 2 to identify the features and standard accessories of your Product.

Table 2. Features

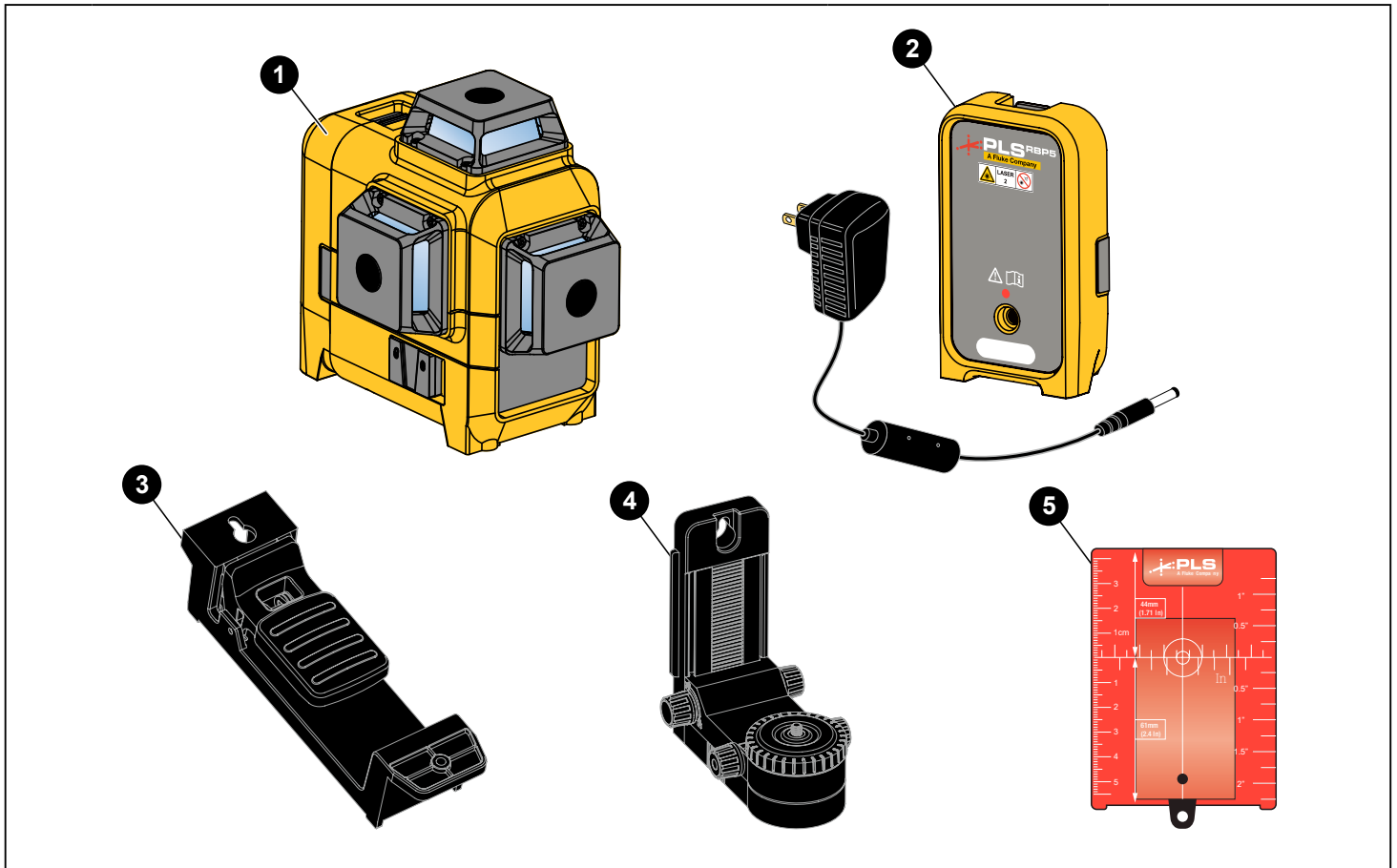

Item	Description	3X360R, 3X360G Z	3X360R, 3X360G KIT
①	The Product	●	●
②	Rechargeable battery pack and power supply	○	●
③	3X360 Ceiling Bracket	○	○
④	3X360 Magnetic L-bracket	○	●
⑤	Magnetic reflective target ^[1]	○	●
Not shown	Nylon pouch	●	●
	Blow mold case	○	●

^[1] The 3X360R kits include a red magnetic reflective target. The 3X360G kits include a green magnetic reflective target.

● Standard accessory ○ Optional accessory

Lasers and Optical Glass

Table 3 shows the lasers and optical glass.

Table 3. Lasers and Optical Glass

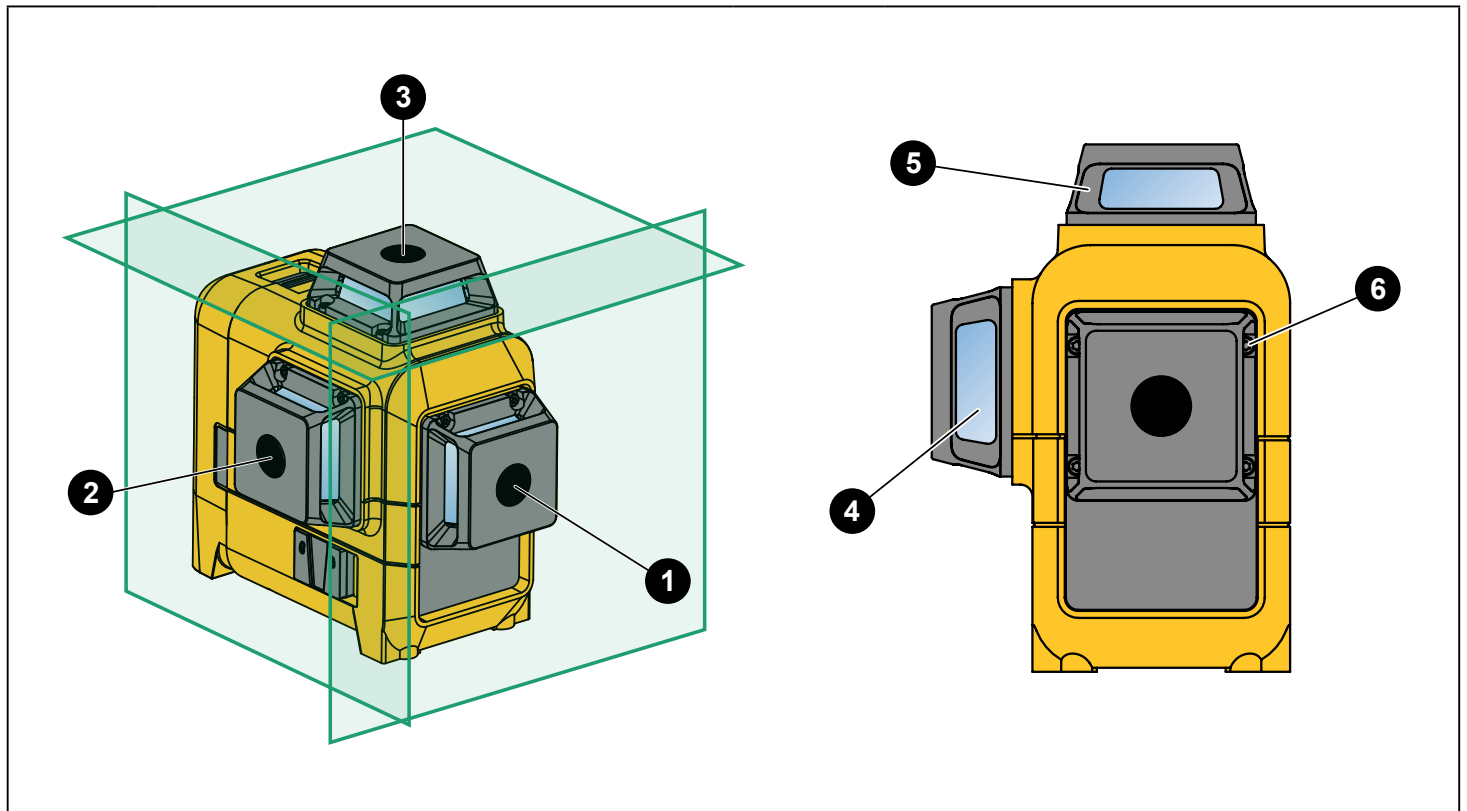

The diagram illustrates the laser level with various components labeled. On the left, a 3D perspective view shows the device with three laser lines: a horizontal line (3), a front vertical line (1), and a side vertical line (2). On the right, a top-down view shows the housing with a tower insert (5), a housing glass insert (4), and housing glass insert screws (6).

Item	Description	Item	Description
1	Front vertical 360° line laser	4	Housing glass insert
2	Side vertical 360° line laser	5	Tower insert
3	Horizontal 360° line laser	6	Housing glass insert screws

Controls

Table 4 lists the Controls of the Product.

Table 4. Controls

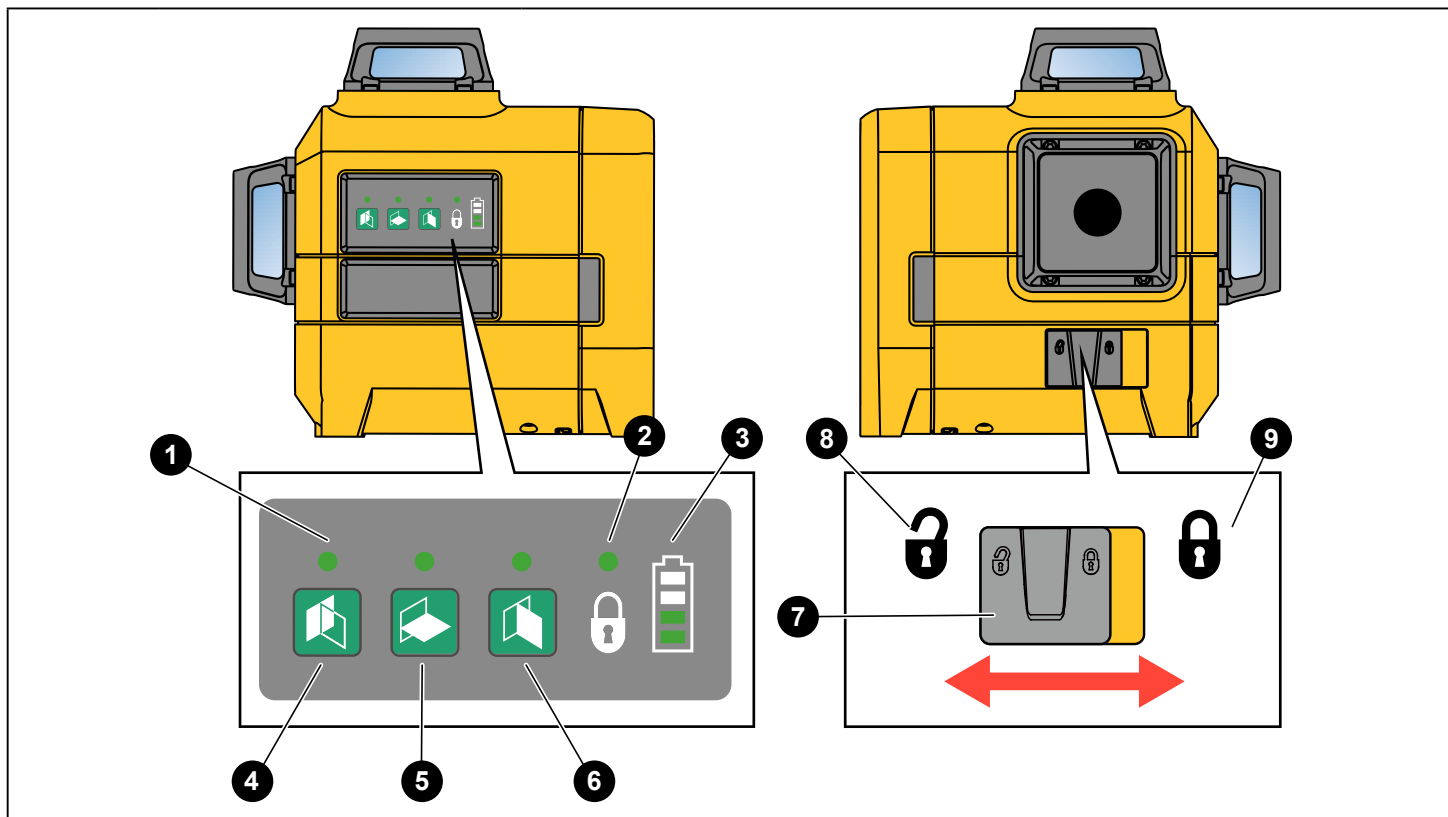

Item	Description	Function
1	Laser LED	Shows green when at least one laser is on.
2	Pendulum Lock LED	Shows green when the pendulum lock is enabled.
3	Battery LED	Battery life indication.
4	Front vertical laser button	Turns on or off the front vertical laser.
5	Horizontal laser button	Turns on or off the horizontal laser.
6	Side vertical laser button	Turns on or off the side vertical laser.
7	Pendulum lock	Slides to lock or unlock the lasers.
8	Pendulum unlock position	The self-leveling feature, keeps the lasers visible when the Product tilts $\leq 4^\circ$ in any direction. When the Product tilts $>6^\circ$ in any direction, the lasers do not show. The Laser indicator LED stays green to indicate that when you return the Product to an upright position, the lasers show again.
9	Pendulum lock position	Keeps the lasers visible even when you tilt the Product. The lasers blink twice every 5 seconds to indicate the self-leveling feature is disabled. Use to align items diagonally such as a stair rail.

Check Product Accuracy

Cone Accuracy

Table 5

D Laser to a is 1m	E
3 m	≤ 1.6 mm
4 m	≤ 2 mm
5 m	≤ 2.4 mm
9 m	≤ 4 mm
D Laser to a is 3.2 ft	E
9.8 ft	≤ 1/16 in
13.1 ft	≤ 5/64 in
16.4 ft	≤ 3/32 in
29.5 ft	≤ 5/32 in

1. Place the laser on a flat surface going in one direction.
2. Turn on the horizontal beam  and project on the parallel wall. You will need to have a set distance between (a,b) which will be referred to as "D" with the horizontal beam.

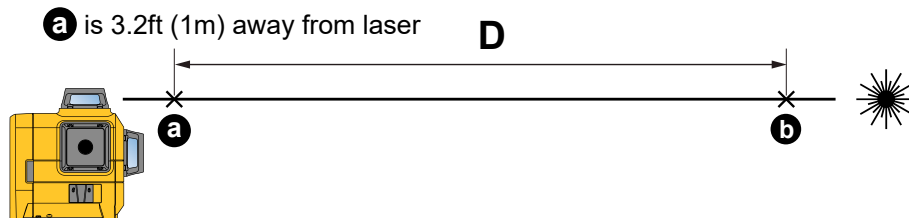

illustration 1

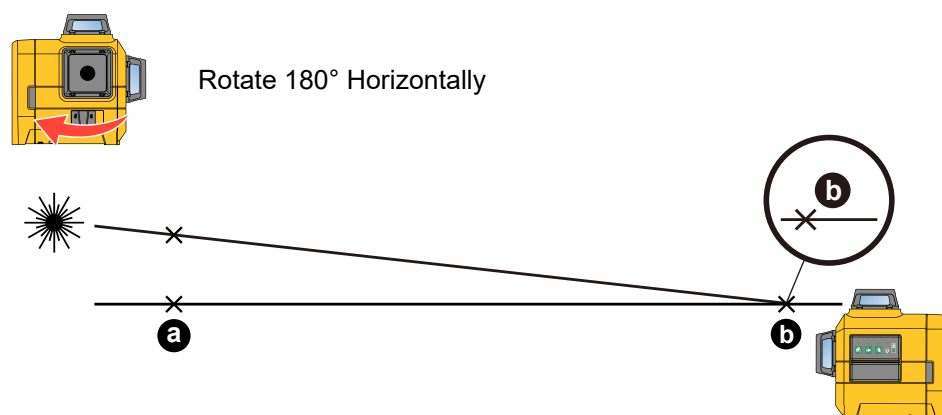



illustration 2

3. Rotate the laser 180 degrees horizontally and place at point b, as seen above .
4. Turn on the horizontal beam  and adjust the laser height so the center of the beam is aligned with mark b.

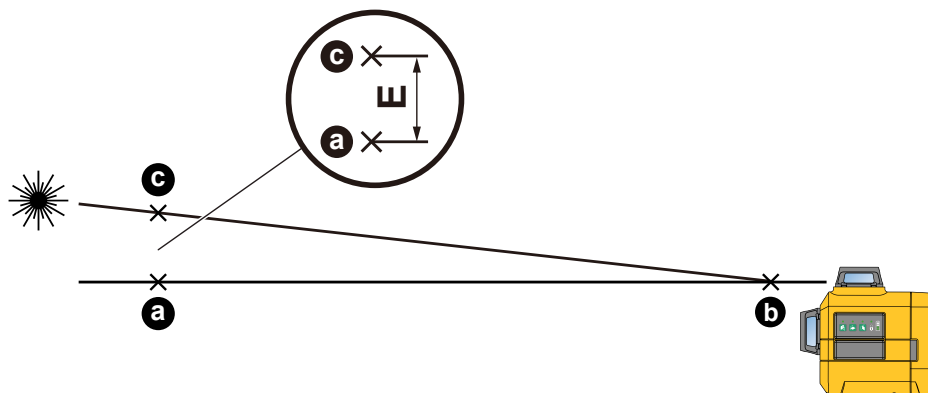

illustration 3

5. Mark c directly above or below a.
6. Measure the distance between these two marks (a,c). If the measurement value is greater than the corresponding E value, take to your service provider.

Horizontal Leveling Accuracy

Table 6

D Laser to a is 1m	E, F, G
3 m	≤ 1.6 mm
4 m	≤ 2 mm
5 m	≤ 2.4 mm
9 m	≤ 4 mm
D Laser to a is 3.2 ft	E, F, G
9.8 ft	≤ 1/16 in
13.1 ft	≤ 5/64 in
16.4 ft	≤ 3/32 in
29.5 ft	≤ 5/32 in

It is important to conduct an accuracy check at the expected working distance for the specific use case and is illustrated in Table 6.

1. Place the laser on a flat surface going in one direction. You will need to have a set distance between (a,b) which will be referred to as "D".
2. Turn on the horizontal beam and mark (a,b) 

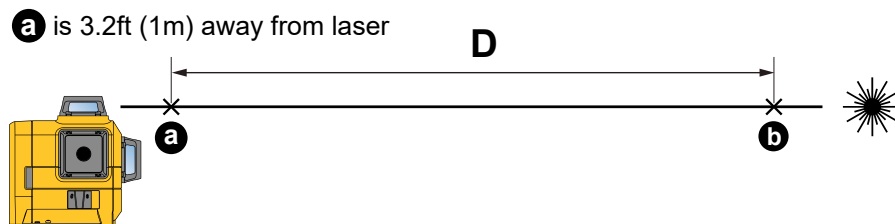

illustration 1

3. Once "D" is identified based on illustration 1, rotate the laser 90 degrees horizontally as seen below.
4. Mark c and calculate the distance between c,b and this is F.

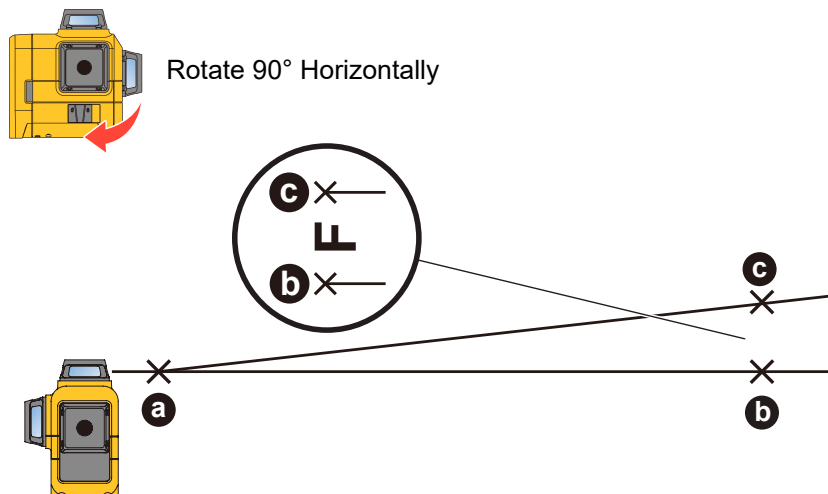

illustration 2

5. Rotate the laser 180 degrees horizontally as seen below.
6. Mark d and calculate the distance between d,b and this is E.

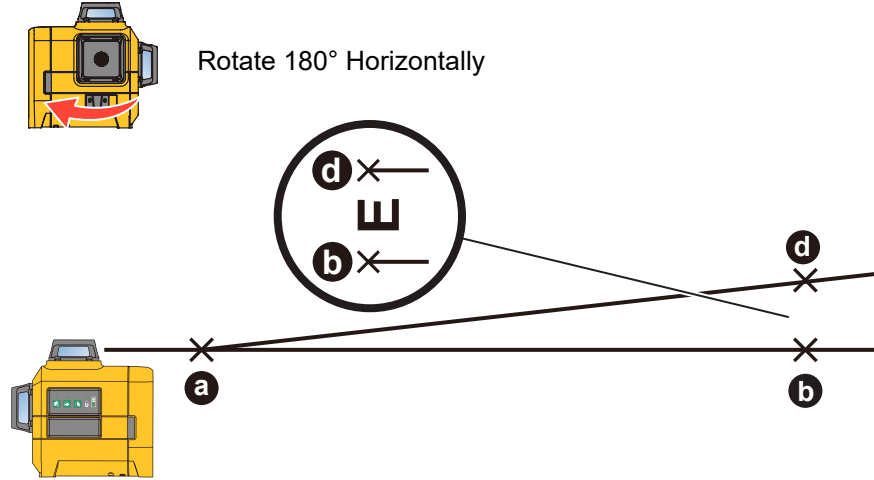

illustration 3

7. Rotate the laser 270 degrees horizontally as seen below.
8. Mark e and calculate the distance between e,b and this is G.
9. If any of the values are greater than the respective E,F,G column values, take to your service provider.

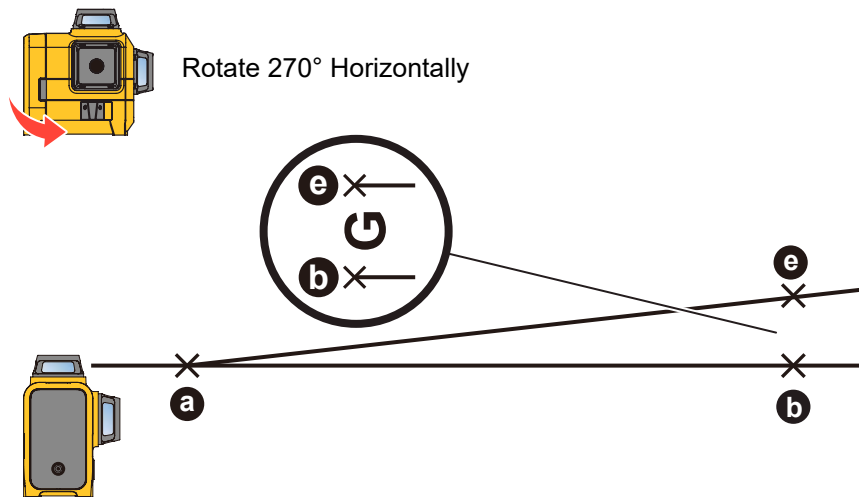

illustration 4

Vertical Accuracy

Table 7

J	K & L
2.5 m	≤ 1 mm
3 m	≤ 1.2 mm
4 m	≤ 1.6 mm
5 m	≤ 2 mm
10 m	≤ 4 mm
J	K & L
8.2 ft	≤ 3/64 in
9.8 ft	≤ 3/64 in
13.1 ft	≤ 1/16 in
16.4 ft	≤ 5/64 in
32.8 ft	≤ 5/32 in

It is important to conduct an accuracy check at the expected working distance for the specific use case and is illustrated in Table 7.

1. Place the laser on a flat surface that is even in both directions across.
 - a. The height of the room used should reflect with the corresponding values under column "J"

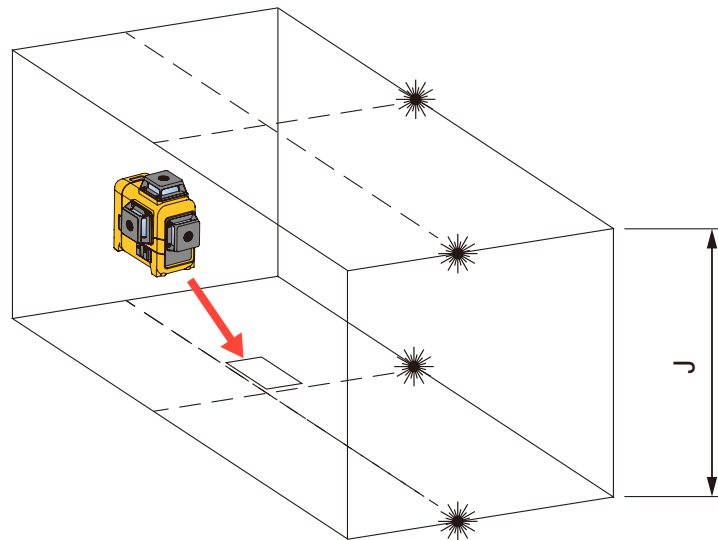

illustration 1

2. Turn on both vertical beams  + 

a. Mark two short lines where both vertical beams intersect on points (a,b) and (c,d).

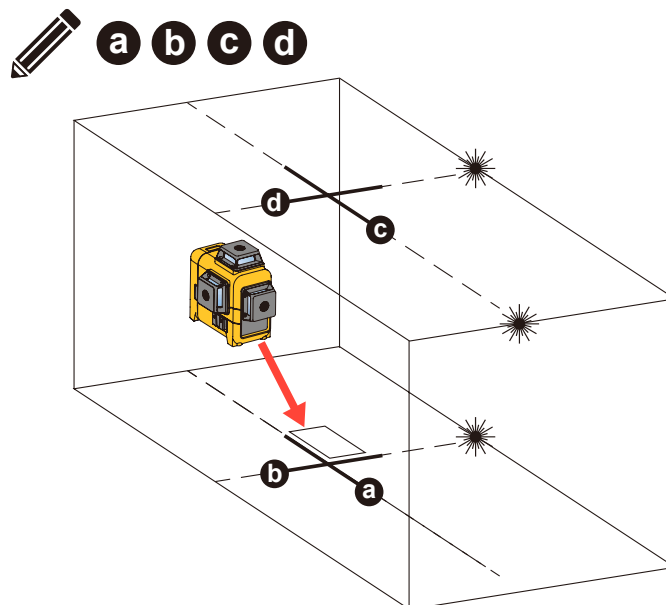

illustration 2

3. Pick up and rotate the laser 180 degrees then position the vertical beams with existing (a,b) marks. These marks on the ground become (e,f).

4. On the ceiling, mark two short lines (g,h)

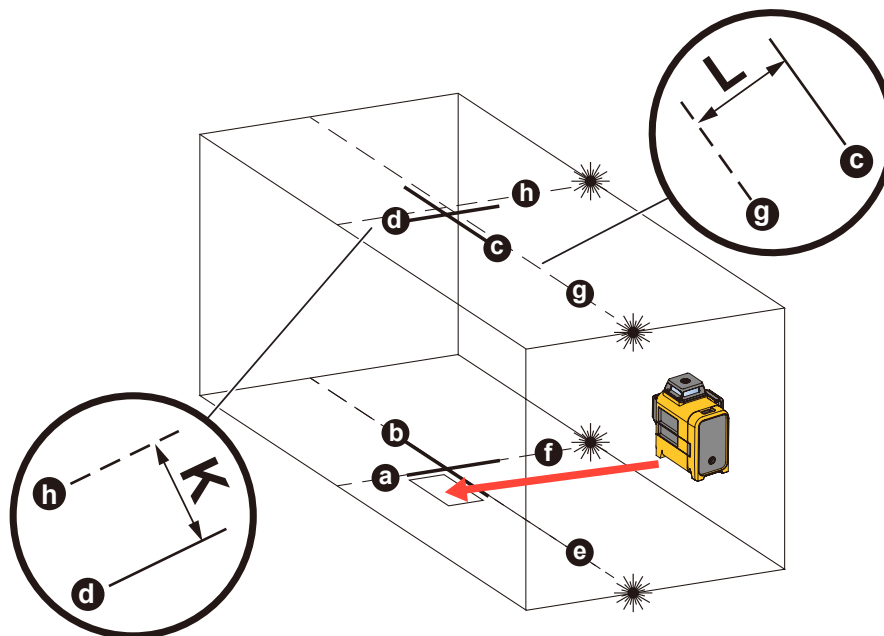

illustration 3

5. Measure the distance between (h,d) and this value is K.

6. Measure the distance between (c,g) and this value is L

7. Review your applicable row for vertical distance is less than or equal to K & L. If greater than the values, take to your service provider.

90 Degree Accuracy

Table 8

A,B,C	D
3 m	≤ 1.2 mm
4 m	≤ 1.6 mm
5 m	≤ 2 mm
10 m	≤ 4 mm
A,B,C	D
9.8 ft	≤ 3/64 in
13.1 ft	≤ 1/16 in
16.4 ft	≤ 5/64 in
32.8 ft	≤ 5/32 in

Checking 90 degree accuracy requires a large open floor space. Distances A,B,C can be chosen based on your application and distance to use.

1. Place the laser on a smooth, flat and stable surface that is level in both directions.
2. Turn on the side vertical beam. 
3. Mark the center of the beam at three locations on the ground, as seen below at (a,b,c) and (b) should be the midpoint of the entire line length.

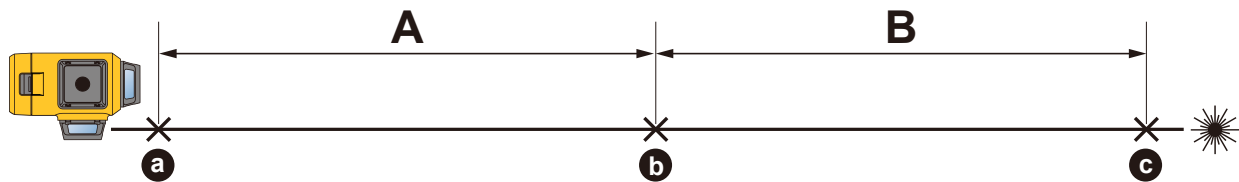



illustration 1

4. Move the laser to mark b and turn on both vertical beams  + 
5. Position the beam crossing precisely at mark b.
6. Mark location d along the front vertical beam at set distance C.

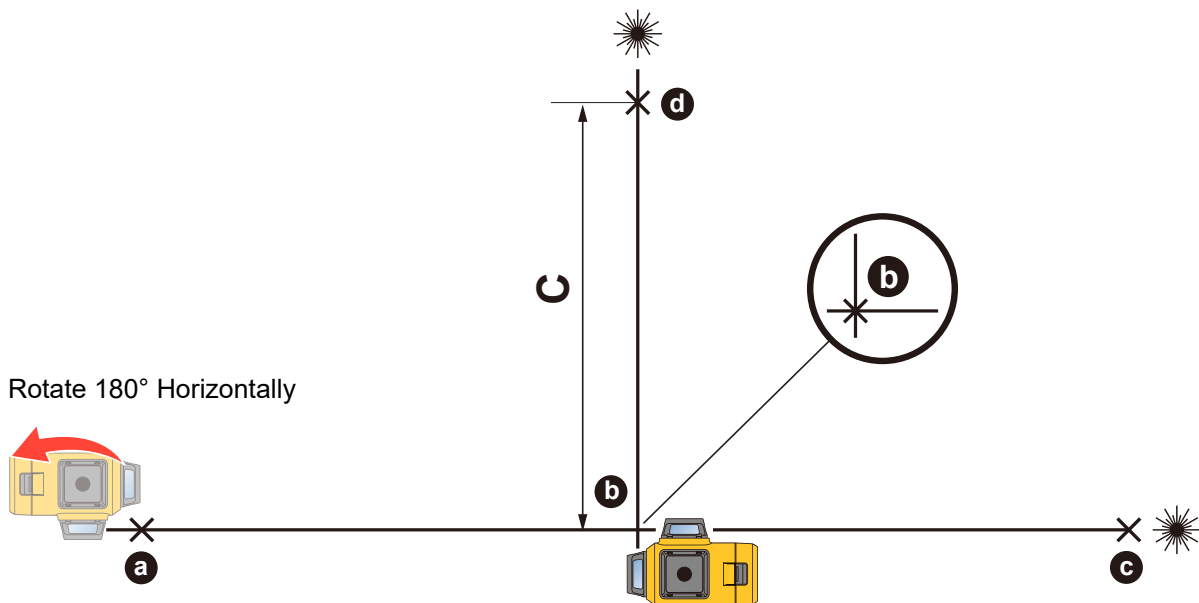
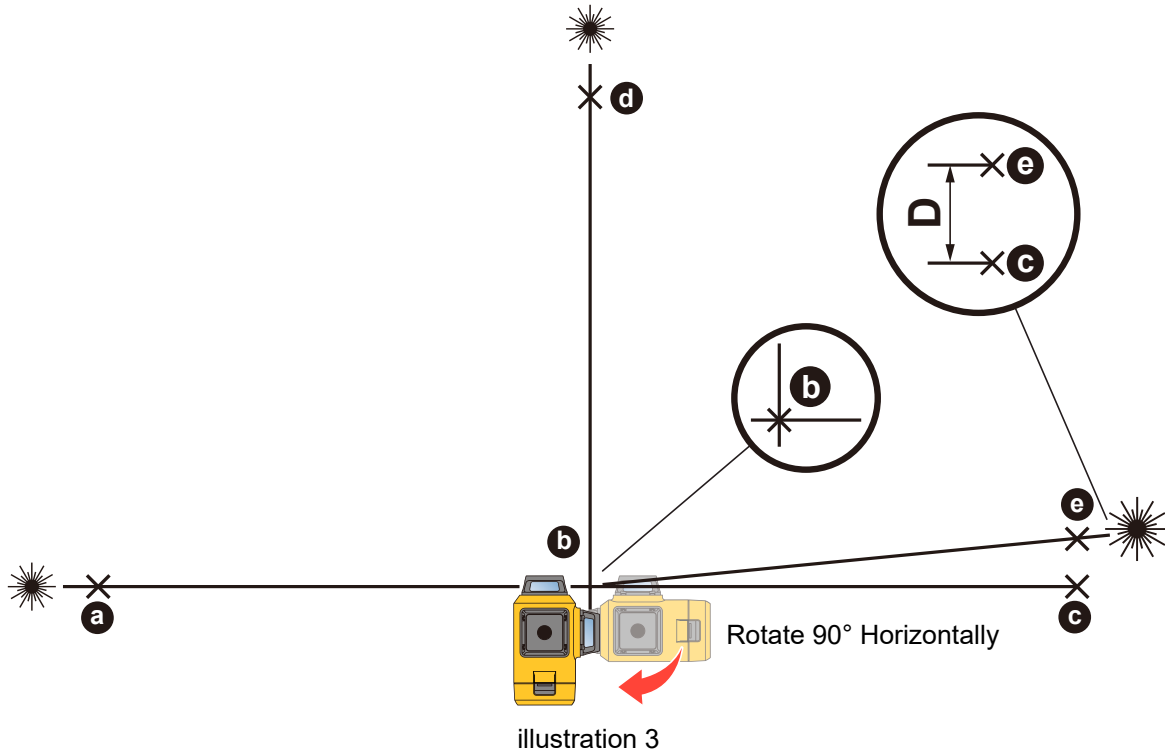

illustration 2

7. Rotate the laser 90 degrees horizontally
8. Position the front and side vertical beams with (b).
9. Mark e and measure the distance (D) between (c,e).
10. If the value is greater than D values, take to your service provider.



Accessories

Table 9 is a list of the accessories available for the Product.

Table 9. Accessories

Model	Description	PN
PLS HGI3X360R	PLS Housing glass insert for PLS 3x360R	5204916
PLS HGI3X360G	PLS Housing glass insert for PLS 3x360G	5214800
PLS 3X360 MLB	Magnetic L-bracket w/ micro and elevation adj	5214817
PLS 3X360 CB	Ceiling bracket used w/ PLS 3X360 MLB	5214821
PLS XLD+	PLS Universal rotary/line laser detector w/ clamp	5221059
PLS 3X360 HC	PLS 3X360 blow mold hard case	5221067
PLS RBP5	Li-ion battery for handheld lasers w/ charging cord	5023322
PLS RRT4	Red magnetic reflective target	5022629
PLS GRT4	Green magnetic reflective target	5022634

Note: PLS 3X360 is not compatible with PLS BP5 alkaline battery pack (PN 5031952)

3X360 Magnetic L-bracket and Ceiling Bracket

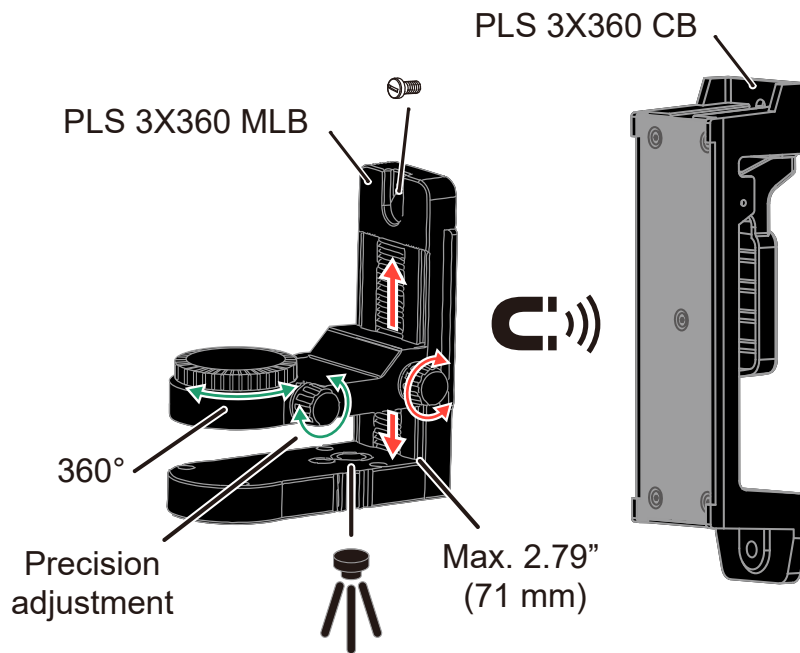

Figure 1

3X360 MLB Magnetic L-bracket

Horizontal rotation	360°
Horizontal rotation precision adjustment	Yes
Elevation adjustment	Max. 2.79 in (71 mm)
Elevation adjustment lock*	Yes
Laser level mounting screw	1/4-20 UNC male threaded
Tripod mounting hole	1/4-20 UNC female threaded, 5/8-11 UNC female threaded
Wall hanging hole	Max. 0.53 in (13.5 mm)
Dimensions (H x W x D)	Approx. 5.9 x 3.3 x 5.4 in (150 x 87.3 x 137 mm)
Weight	Approx. 0.86 lb (0.39 kg)

Note: * the elevation adjustment lock provides 2X friction.

3X360 CB Ceiling Bracket

Compatibility	3X360 MLB
Clamp opening	Max. 0.118 in (3 mm)
Dimensions (H x W x D)	Approx. 9.84 x 2.52 x 2.4 in (250 x 64 x 61 mm)
Weight	Approx. 0.84 lb(0.38 kg)

Maintenance

To maintain the Product, clean the case and optical glass and replace the batteries.

⚠️⚠️ Warning

To prevent eye damage and personal injury, do not open the Product. The laser beam is dangerous to the eyes.

⚠️ Caution

To prevent damage to the Product, do not drop the Product. Treat the Product as a calibrated instrument.

Clean the Product

Clean the case with a damp cloth and a weak soap solution.

⚠️ Caution

To prevent damage to the Product, do not use abrasives, isopropyl alcohol, or solvents to clean the case or optic windows.

To clean the optical glass, use a pressurized can of air or a dry nitrogen-ion gun, if available, to blow off particulates from the optical surfaces.

Replacing Battery

Replace the battery when the battery indicator LED is red.

To install or replace RBP5 (Li-ion) using AA battery tray is not commended due to extremely short battery life (see Figure 2):

1. Press down on the latch **1**.
2. While pressing down, pull back on battery pack and remove.
3. Reinstall recharged battery pack.

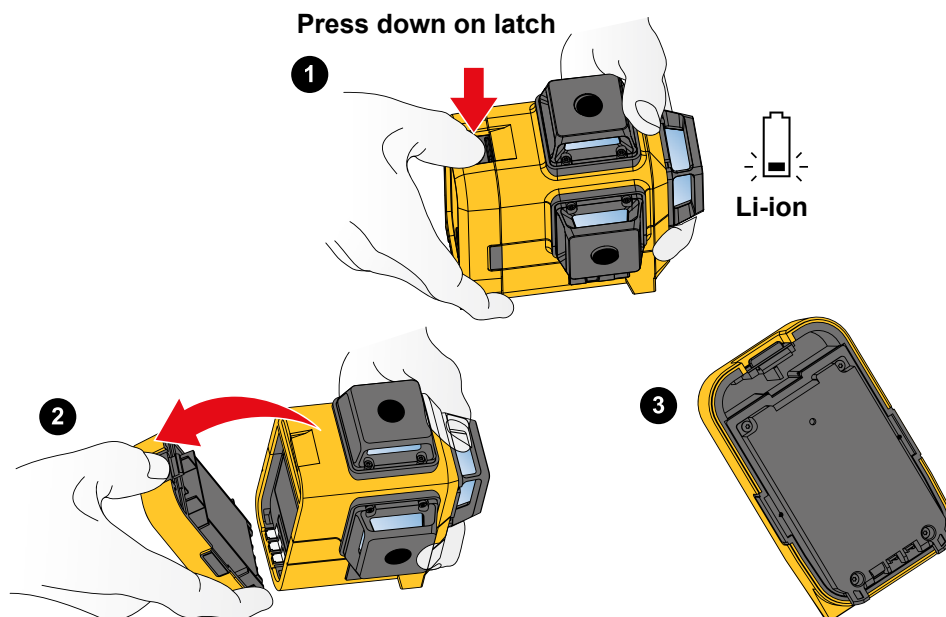

Figure 2. Battery Replacement

RBP5 Rechargeable Battery

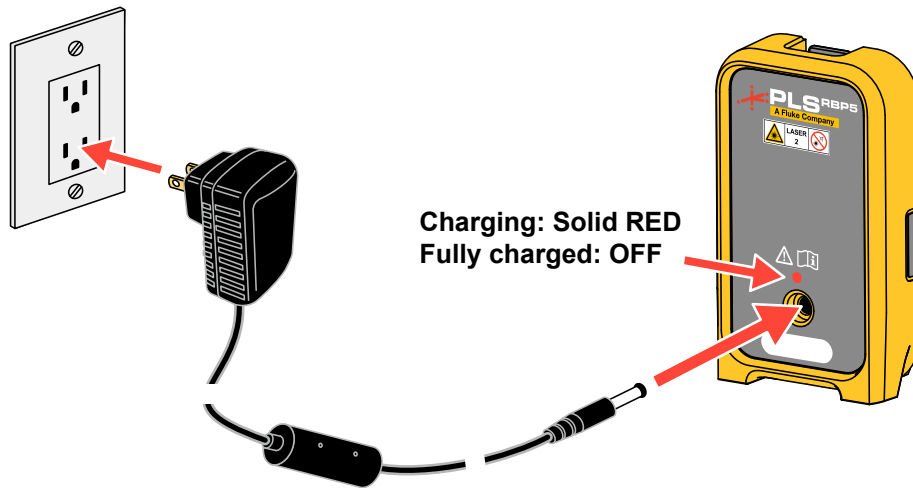

Figure 3

Housing Glass Insert

If the optical glass is damaged, replace the housing glass insert. See Table 6 for the part number to order for your Product. To replace the housing glass insert (see Figure 4):

1. Remove the four housing glass insert screws
2. Pull out the the tower insert and glass insert.
3. Replace the insert and re-fasten screws.

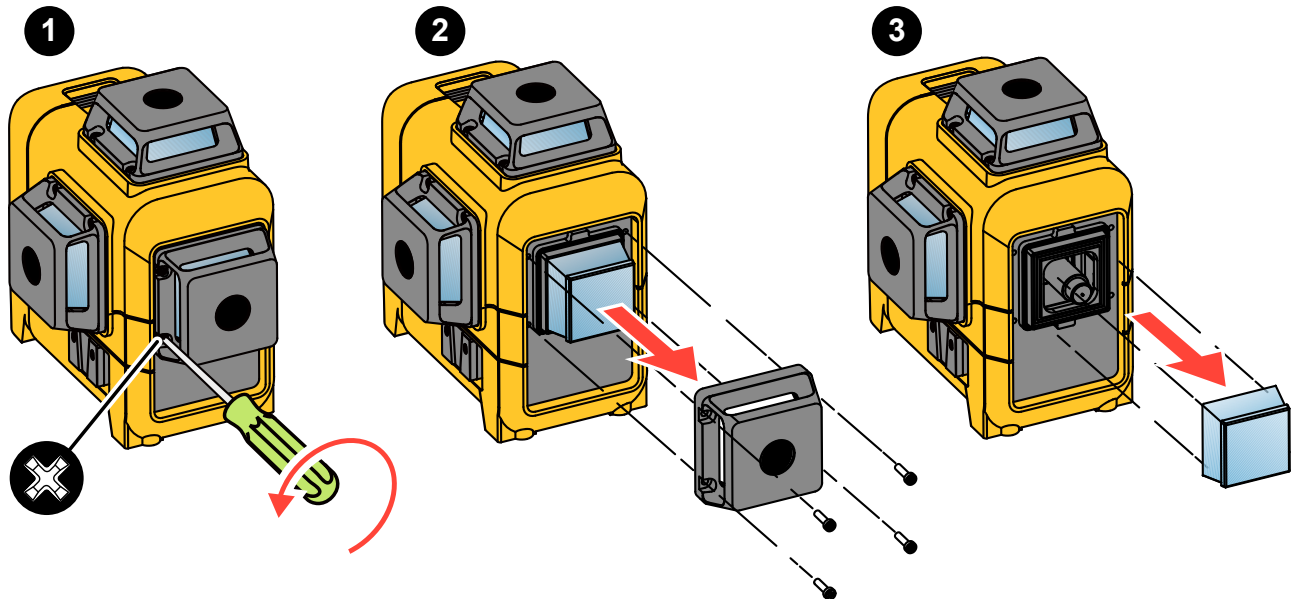

Figure 4. Housing Glass Insert Replacement

Specifications

Specifications	PLS 3X360R	PLS 3X360G
Battery (RBP5)	Lithium-ion, 3.6 V, 5200 mAh	
Battery Life, Continuous Use (typical)	3 beams: ≥ 9 hours 1 beam: ≤ 30 hours	3 beams: ≥ 5 hours 1 beam: ≤ 17 hours
Line Fan Angle		
Horizontal	360°	
Front Vertical	360°	
Side Vertical	360°	
Working Range		
Without line detector	65 ft (20 m)	115 ft (35 m)
With line detector	165 ft (50 m)	210 ft (65 m)
Accuracy	± 5/64 in @ 33 ft (± 2 mm @ 10 m)	
Laser Leveling		
System	Automatic Pendulum	
Range	Self-leveling: ≤ 4° Out of self-levelling: > 6°	
Leveling time	≤ 3 sec	
Temperature		
Operating	14 °F to 122 °F (-10 °C to 50 °C)	
Storage	With Battery: -4 °F to 122 °F (-20 °C to 50 °C) Without Battery: -13 °F to 158 °F (-25 °C to 70 °C)	
Relative Humidity	0 % RH to 90 % RH (0 °C to 35 °C) 0 % RH to 75 % RH (35 °C to 40 °C) 0 % RH to 45 % RH (40 °C to 50 °C)	
IP rating	IP 54	
Drop test	3.28 ft (1 m)	
Battery status indication	100%, 75%, 50%, 25% and low battery	
Size (H x W x L) w/ RBP5	5.12 in x 3.58 in x 5.25 in (13 cm x 9.09 cm x 13.33 cm)	
Weight (with battery)	1.76 lbs (0.8 kg)	
Li-ion battery safety	IEC 62133	
Laser Safety	Class 2 (IEC 60825-1)	
Light Source	Semiconduction laser diode	
Max Output Power	< 1 mW	
Wavelength		
Red	635 nm ± 10 nm	
Green	520 nm ± 10 nm	
Electromagnetic Compatibility (EMC)		
International	IEC 61326-1	
Korea (KCC)	Class A Equipment (Industrial Broadcasting & Communication Equipment) ^[1] ^[1] This product meets requirements for industrial (Class A) electromagnetic wave equipment and the seller or user should take notice of it. This equipment is intended for use in business environments and is not to be used in homes.	
USA (FCC) 47	47 CFR 15 subpart B. This product is considered an exempt device per clause 15.103.	