

Version
04.00December
2005

Dual-Channel Power Meter R&S®NRVD

Power, level and voltage measurements from DC to 40 GHz

- ◆ Accurate, general-purpose, easy-to-use
- ◆ Attenuation and reflection measurements
- ◆ Two independent channels measuring simultaneously
- ◆ Operating modes: average power, reflection, pulse power, AM, DC
- ◆ Manual or automatic range selection
- ◆ Intelligent sensors – simply plug in and measure
- ◆ Readout: absolute in W, dBm, V, dBV, dB μ V, relative in dB, %, A/B, B/A, A–B, B–A
- ◆ Remote control of all functions via IEC/IEEE bus in line with SCPI



ROHDE & SCHWARZ



The R&S® NRVD covers a total bandwidth of 40 GHz and a power span from 100 pW up to the kW range. Being individually and absolutely calibrated, the sensors can be interchanged as required without impairing measurement accuracy.

The wide range of sensors includes thermal power sensors, high-sensitivity diode sensors, peak power sensors as well as probes and insertion units for voltage measurements.

All you need – and lots more

- ◆ LC display with variable backlighting, separate digital readout for each channel, bargraph indicator
- ◆ Softkeys for control via menus
- ◆ Entry of reference values for level and attenuation
- ◆ 13 digital filters for noise suppression, manual or automatic filter selection
- ◆ Storage of 20 instrument setups
- ◆ Input/output option with DC frequency input, analog outputs, trigger input, ready output
- ◆ Rear connectors for sensors in system operation
- ◆ Generator for testing sensors
- ◆ Correction of frequency response of sensors: frequency entry via keyboard, IEC/IEEE bus or by means of a frequency-proportional DC voltage

Two instruments in one

The R&S® NRVD is not just a power meter with two inputs; it functions like two independent measuring instruments in one cabinet that perform measurements simultaneously and exchange data with one another. The two

channels can be separately set so that two completely different measurements can be carried out at the same time. The two measured values can also be related to each other for direct indication of reflection coefficient, SWR and return loss, for instance, when a SWR bridge is connected to the meter.

Operation

Operation of the power meter is to a great extent via self-explanatory menus so that the user will hardly ever have to refer to the manual.

For setting the instrument rapidly to a specific status, 20 complete setups can be stored. A selectable write protection prevents inadvertent alteration of stored setup data.

All measuring and setting functions of the R&S® NRVD can be remote-controlled. The IEC/IEEE bus syntax complies with the Standard Commands for Programmable Instruments (SCPI).

Measurement rate

The attainable measurement rate not only depends on the type of sensor used but also on the setting of the display filter, which must be matched to the measurement conditions. Taking into account the connected sensor, the R&S® NRVD automatically selects the appropriate measurement rate by determining the optimum averaging time required for a noise-free display as a function of level and selected resolution. This automatic selection can be disabled and an averaging time of between 4 ms and 25 s can be set manually to further reduce the noise or to measure faster than in automatic operation.

Test generator

This generator makes it possible to check the connected sensors for damage or destruction, e.g. after overloading or excessive mechanical stress. It generates a low-distortion, highly accurate 50 MHz signal of 1 mW power (0 dBm).

Readout

Measurement results are displayed with a selectable resolution on a five-digit LCD with adjustable backlighting. The values measured in the two channels or one measured value and an item of information, e.g. the correction frequency, are displayed simultaneously.

All standard units of measurement or relative modes can be selected. Relative measurements are either referenced to a stored reference value or to the value measured in the second channel. A high-resolution bargraph indicator with selectable scaling or autoscaling permits quasi-analog display of measured values with any unit or resolution.

The characters PEP or PUL preceding the numeric value denote the peak envelope power (measured with a peak power sensor of the R&S®NRV-Z3x series) or the pulse power, respectively. The pulse power is a calculated peak value for RF bursts with rectangular envelope. It is based on the duty factor and the average power value. Pulse power measurements can be made using thermal sensors as well as diode sensors operated in the square-law region. On request, the modulation depth of an amplitude-modulated signal can be determined from the power variation when switching the modulation on.

After entering the SWR of the source, the expected measurement uncertainty can be displayed together with the measured value for all thermal sensors and some diode sensors.

Dual-channel measurement and readout: left channel in dBm, right channel in mW; bargraph allocated to left channel

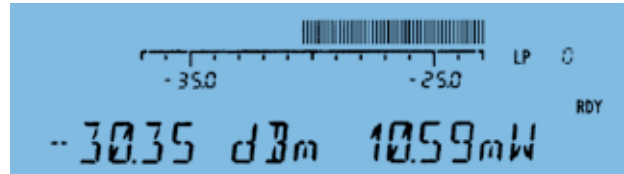

Readout of correction frequency together with measured value

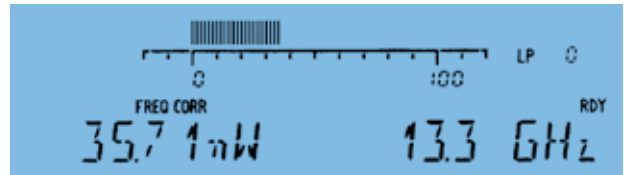

Readout of pulse power after entry of duty factor



Readout of modulation depth of an amplitude-modulated signal

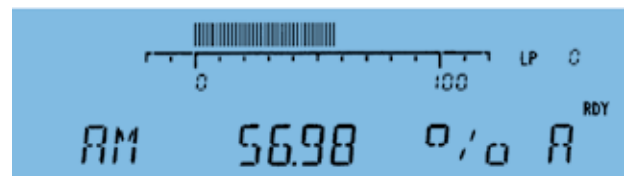

Readout of reflection coefficient

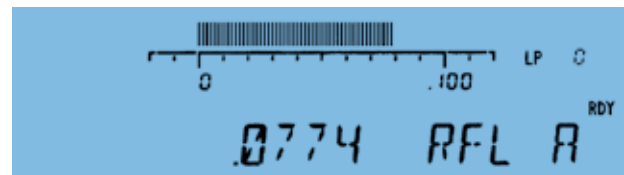

I/O Option R&S®NRVD-B2

The R&S®NRVD-B2 option provides a number of inputs and outputs that extend the application range of the R&S®NRVD. For instance, a 12-bit resolution, analog output with selectable scaling is allocated to each measuring channel for connecting a recorder or for control purposes. With the aid of the trigger input or the ready output, measurements can be automated by simple control means. Another input takes up the frequency-proportional DC voltage from a sweep generator that may be used for driving the test setup. The R&S®NRVD uses this information for automatic frequency response correction (see also "Measurement accuracy").

Sensors

Power meters cover a wide range of applications and a great variety of frequency and power ranges. Since suitable sensors are available for the various applications and ranges, the only factors that decide the selection of a power meter are versatility, system compatibility and ease of operation. In these aspects the R&S®NRVD is a top-class unit.

Thermal power sensors measure the average power irrespective of the signal shape and meet the highest demands on accuracy. Diode sensors are more sensitive – they are able to measure power down to the pW range – but their measurement accuracy is impaired when high-level, non-sinusoidal signals are to be measured. In the medium sensitivity range, it is recommended to use diode sensors with integrated attenuator, e.g. the R&S®NRV-Z2. This combination not only allows considerably faster level measurements in the range between 10 μ W and 100 μ W than a thermal power sensor; it also offers better matching than a highly sensitive diode detector and still measures true rms power.

The peak envelope power of modulated signals can be measured by means of a peak power sensor of the R&S®NRV-Z3x series. These sensors are suitable for sync peak power measurements on TV transmitters and transmitter power measurements on TDMA radio equipment or for general applications. Peak power sensors, which consist of a fast diode detector followed by a peak-hold circuit, are calibrated individually like all Rohde & Schwarz power sensors. Besides the R&S®NRV-Z power sensors, all R&S®URV5-Z voltage probes can be used with the R&S®NRVD.

Measurement accuracy

The accuracy of an RF power measurement essentially depends on the characteristics of the sensor. Errors encountered in this case are a function of level, temperature and frequency and cannot be eliminated completely by design.

Error sources of power sensors:

- ◆ Non-linearity
- ◆ Level-dependent temperature effect
- ◆ Frequency response

To be able to measure correctly under any conditions, deviations from the ideal must be registered numerically and taken into account in the measurement result. The usual way to obtain accurate results is to calibrate the sensors with the aid of a generator prior to their use. The disadvantages of this method are obvious: a calibration has to be performed before each measurement, for each individual sensor and even at intervals during a measurement (in the case of temperature variations). For this reason, Rohde & Schwarz has for years been producing sensors that offer great convenience to the user, although at a higher expenditure on the part of the manufacturer. This technique can be summarized as:

Plug in and go

All relevant parameters are measured in the factory individually for each sensor and then stored in the sensor. The level-dependent temperature effect is represented as a two-dimensional characteristic with a great number of measurement points.

Each sensor comprises a temperature sensor, the signal of which is evaluated in the power meter at regular intervals. From the measured temperature and level values, the stored characteristic yields the correction values for the output voltage of the sensor. The input power is then calculated from this corrected voltage with the aid of a transfer function which is also stored in the sensor.

Finally, frequency-response correction is carried out. The R&S®NRVD multiplies the calculated input power with the correction factor for the signal frequency. This frequency is either obtained from the frequency input of option R&S®NRVD-B2 or entered by the user.

This comprehensive error correction technique offers the following advantages:

- ◆ Unrestricted exchange of sensors due to individual calibration
- ◆ Optimum measurement accuracy
- ◆ Calibration of sensors directly traceable to PTB standards
- ◆ Fast and convenient operation

In spite of all these corrective measures, one uncertainty remains which is not caused by the sensor but by a possible mismatch of sensor and signal source.

As an example, the power applied from a source to a load with a characteristic impedance Z_0 (50 Ω or 75 Ω) is to be measured. The output impedance of the source and the input impedance of the sensor, which acts as a load, deviate from Z_0 to some extent. This mismatch at both ends causes a measurement error which is often ignored because it cannot be specified for the sensor separately. The error depends on the degree of mismatch between source and sensor (see diagram on page 8). Since, generally, the SWR of the source cannot be varied, the measurement accuracy can only be increased by selecting a low-reflection sensor. Since all R&S®NRV-Z power sensors offer excellent SWR characteristics, no wrong choice can be made.

Applications

SWR measurement

Simultaneous measurement of forward and reflected power allows direct read-out of reflection coefficient, SWR or return loss.

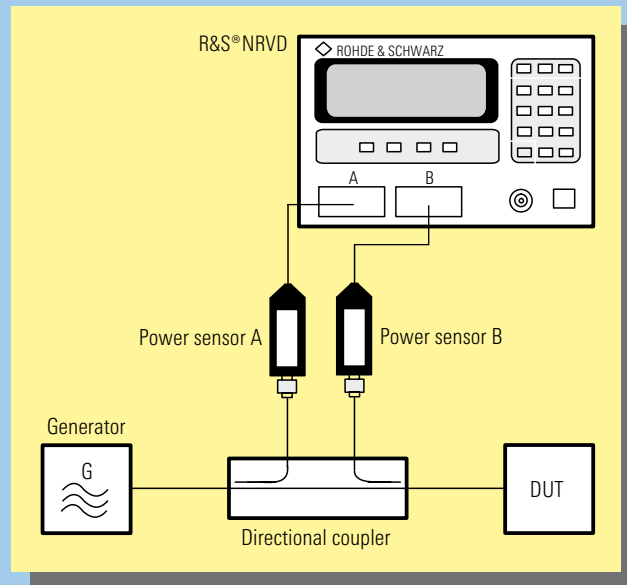

Sweep tester with automatic frequency response correction

For correcting the frequency response of a sensor, the R&S®NRVD is able to calculate the test frequency from a voltage as is available at the sawtooth output of a sweep generator. The result is an easy-to-use sweep tester with automatic frequency response correction.

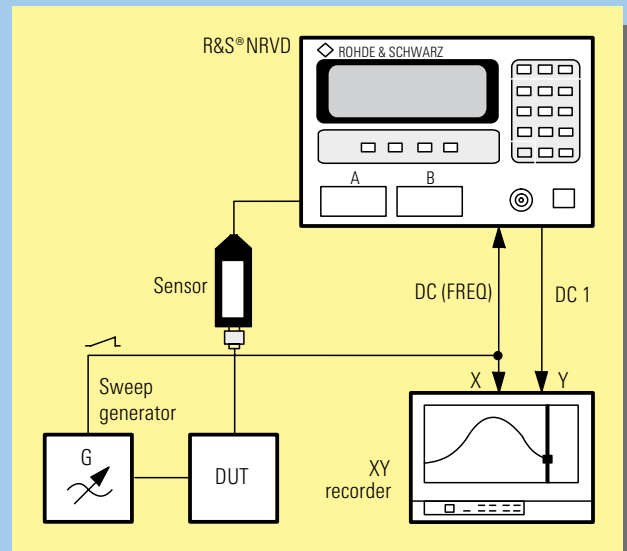

Attenuation measurements

This setup is used for highly accurate attenuation measurements. By using a reference sensor (A), test results are independent from generator level variations. The power splitter reduces matching errors.

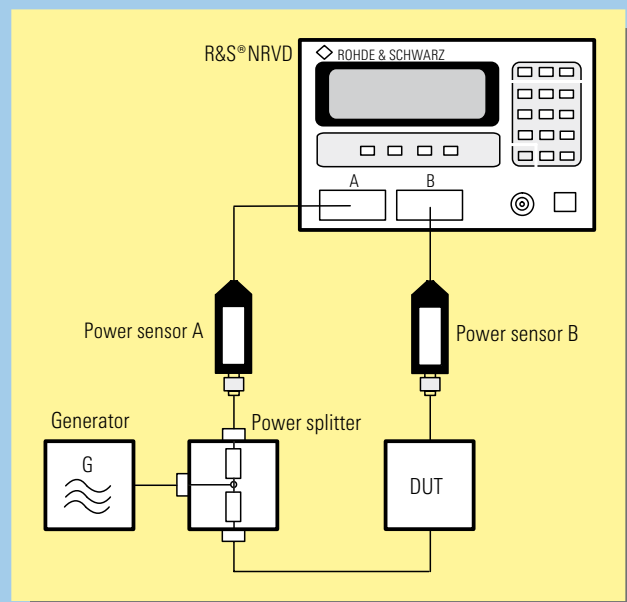



Power sensors

R&S®NRV-Z1 828.3018.02	Diode Power Sensor 50 Ω 10 MHz to 18 GHz, 200 pW to 20 mW	Power measurements of highest sensitivity up to 18 GHz in 50 Ω systems
R&S®NRV-Z2 828.3218.02	Diode Power Sensor 50 Ω 10 MHz to 18 GHz, 20 nW to 500 mW	Power measurements with minimum mismatch, for high powers in 50 Ω systems
R&S®NRV-Z3 828.3418.02	Diode Power Sensor 75 Ω 1 MHz to 2.5 GHz, 100 pW to 13 mW	Power measurements in 75 Ω systems
R&S®NRV-Z4 828.3618.02	Diode Power Sensor 50 Ω 100 kHz to 6 GHz, 100 pW to 20 mW	Power measurements of highest sensitivity in the frequency range 100 kHz to 6 GHz, very large dynamic range
R&S®NRV-Z5 828.3818.02	Diode Power Sensor 50 Ω 100 kHz to 6 GHz, 10 nW to 500 mW	Same as R&S®NRV-Z4, but for high powers and minimum mismatch
R&S®NRV-Z6 828.5010.03	Diode Power Sensor 50 Ω 50 MHz to 26.5 GHz, 400 pW to 20 mW	Power measurements up to 26.5 GHz with high sensitivity and dynamic range in 50 Ω systems, PC 3.5 connector
R&S®NRV-Z15 1081.2305.02	Diode Power Sensor 50 Ω 50 MHz to 40 GHz, 400 pW to 20 mW	Power measurements up to 40 GHz with high sensitivity and dynamic range in 50 Ω systems, 2.92 mm connector
R&S®NRV-Z31 857.9604.02/3/4	Peak Power Sensor 50 Ω 30 MHz to 6 GHz, 1 μW to 20 mW	Peak power measurements, pulse width ≥2 (200) μs, pulse repetition rate ≥10 (100) Hz, 3 models
R&S®NRV-Z32 1031.6807.04/5	Peak Power Sensor 50 Ω 30 MHz to 6 GHz, 100 μW to 2(4) W	Peak power measurements, pulse width ≥2 (200) μs, pulse repetition rate ≥25 (100) Hz, 2 models
R&S®NRV-Z33 1031.6507.03/4	Peak Power Sensor 50 Ω 30 MHz to 6 GHz, 1 mW to 20 W	Peak power measurements up to 20 W, pulse width ≥2 (200) μs, pulse repetition rate ≥100 Hz, 2 models
R&S®NRV-Z51 857.9004.02	Thermal Power Sensor 50 Ω DC to 18 GHz, 1 μW to 100 mW	High-precision power measurement also with non-sinusoidal signals
R&S®NRV-Z52 857.9204.02	Thermal Power Sensor 50 Ω DC to 26.5 GHz, 1 μW to 100 mW	Same as R&S®NRV-Z51, but with PC 3.5 connector for measurements up to 26.5 GHz
R&S®NRV-Z53 858.0500.02	Thermal Power Sensor 50 Ω DC to 18 GHz, 100 μW to 10 W	Power measurements up to 10 W also with non-sinusoidal signals
R&S®NRV-Z54 858.0800.02	Thermal Power Sensor 50 Ω DC to 18 GHz, 300 μW to 30 W	Power measurements up to 30 W also with non-sinusoidal signals
R&S®NRV-Z55 1081.2005.02	Thermal Power Sensor 50 Ω DC to 40 GHz, 1 μW to 100 mW	Same as R&S®NRV-Z51, but with 2.92 mm connector for measurements up to 40 GHz

RF insertion units

R&S®URV5-Z2 395.1019.02	10 V Insertion Unit 50 Ω 200 μV to 10 V, 9 kHz to 3 GHz	Low-load RF voltage measurements in 50 Ω coaxial systems, low-loss power measurements on well-matched RF lines
R&S®URV5-Z4 395.1619.02	100 V Insertion Unit 50 Ω 2 mV to 100 V, 100 kHz to 3 GHz	Virtually no-load RF voltage measurements in coaxial 50 Ω systems even at higher voltages; due to minimum insertion loss and reflection coefficient, this unit leaves a 50 Ω line practically unaffected

Probes

R&S®URV5-Z7 395.2615.02	RF Probe 200 µV to 10 V, 20 kHz to 1 GHz	For measurements in RF circuits at low capacitive and resistive load
With 20 dB plug-on divider ¹⁾	2 mV to 100 V, 1 MHz to 500 MHz	The 20 dB and 40 dB plug-on dividers increase the voltage measurement range of the RF probe; the high Q factor of the capacitive divider makes the resistive loading negligible; the capacitive loading goes down to 0.5 pF (40 dB divider)
With 40 dB plug-on divider ¹⁾	20 mV to 1000 V, 500 kHz to 500 MHz	
With 50 Ω adapter R&S®URV-Z50	200 µV to 10 V, 20 kHz to 1 GHz	With integrated termination for power or level measurements on test items with a source impedance of 50 Ω up to 1 GHz, BNC male/female connector
With 75 Ω adapter R&S®URV-Z3	200 µV to 10 V, 20 kHz to 500 MHz	With integrated termination for power or level measurements in 75 Ω systems such as antenna arrays or video equipment, BNC male
R&S®URV5-Z1 395.0512.02	DC Probes 1 mV to 400 V, 9 MΩ 3 pF	For low-capacitance DC voltage measurements in RF circuits at minimum loading

¹⁾ Part of R&S®URV-Z6.

Automatic filter setting depending on measurement range

Resolution	Filter number						
	11	9	7	7	7	7	7
HIGH 0.001 dB	11	9	7	7	7	7	7
MEDIUM 0.01 dB	9	7	3	3	3	3	3
LOW 0.1 dB	7	3	0	0	0	0	0
R&S®NRV-Z1, -Z3, -Z4, -Z6, -Z15	10 nW	100 nW	1 µW	10 µW	100 µW	1 mW	20 mW
R&S®NRV-Z2, -Z5	1 µW	10 µW	100 µW	1 mW	10 mW	100 mW	500 mW
R&S®NRV-Z31	–	1 µW	10 µW	100 µW	1 mW	20 mW	–
R&S®NRV-Z32	–	100 µW	1 mW	10 mW	100 mW	2 (4) W	–
R&S®NRV-Z33	–	1 mW	10 mW	100 mW	1 W	20 W	–
R&S®NRV-Z51, -Z52, -Z55	10 µW	100 µW	1 mW	10 mW	100 mW	–	–
R&S®NRV-Z53	1 mW	10 mW	100 mW	1 W	10 W	–	–
R&S®NRV-Z54	10 mW	100 mW	1 W	10 W	30 W	–	–
R&S®URV5-Z2, -Z7	–	1 mV	10 mV	100 mV	1 V	10 V	–
R&S®URV5-Z4	–	10 mV	100 mV	1 V	10 V	100 V	–

Measurement time in seconds (from trigger to output of first byte) depending on filter setting

Filter number	0	1	2	3	4	5	6	7	8	9	10	11	12
R&S®NRV-Z1 to -Z15	0.045	0.05	0.06	0.08	0.15	0.27	0.49	0.95	1.85	3.6	7.2	14.5	28.5
R&S®NRV-Z31 model 02	1.04	1.04	1.05	1.07	1.13	1.24	1.44	1.84	2.7	4.3	7.5	14	27
R&S®NRV-Z31/-Z33 model 03/04	0.135	0.14	0.15	0.17	0.23	0.34	0.54	0.94	1.77	3.4	6.6	13	26
R&S®NRV-Z32 model 04	0.135	0.14	0.15	0.17	0.23	0.34	0.54	0.94	1.77	3.4	6.6	13	26
R&S®NRV-Z32 model 05	0.435	0.44	0.45	0.47	0.53	0.64	0.84	1.24	2.07	3.7	6.9	14	27
R&S®NRV-Z51 to -Z55	0.115	0.12	0.13	0.15	0.21	0.32	0.52	0.92	1.75	3.4	6.6	13	26
R&S®URV5-Z2, -Z4, -Z7	0.065	0.07	0.08	0.10	0.20	0.38	0.72	1.45	2.8	5.5	11	22	44

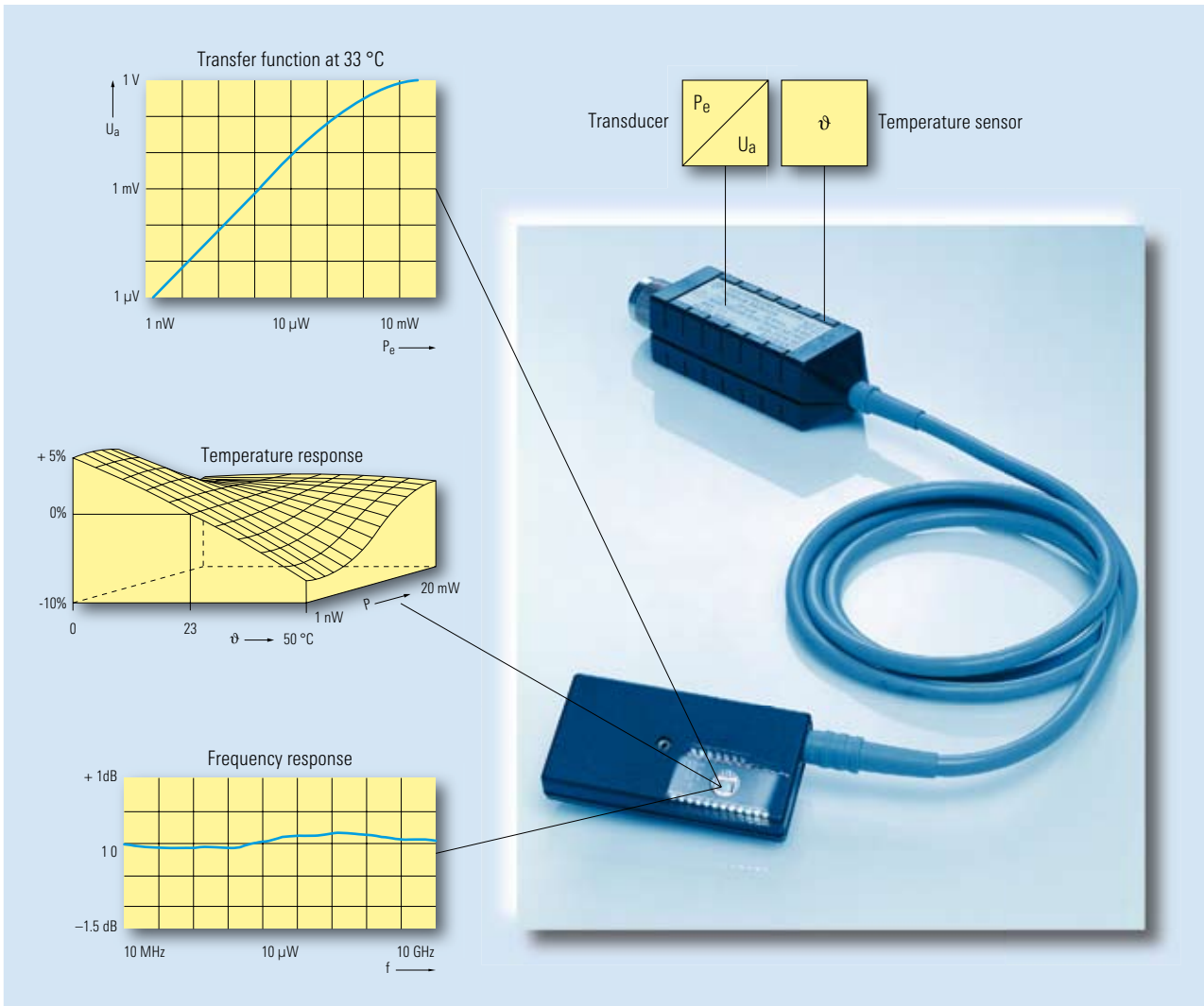

The individual calibration data is stored in a non-volatile memory in the connector of each sensor

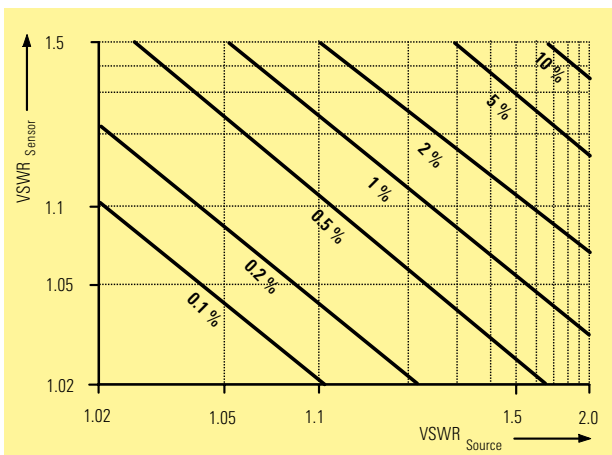

Limits of power measurement error caused by mismatch of sensor and signal source



Rear panel of the R&S®NRVD; for use in test systems, the unit is also available with rear-panel sensor inputs



Thermal Power Sensor
R&S® NRV-Z53

Specifications

Measurement functions	unmodulated and modulated power (average power, pulse power, peak envelope power, AM), reflection, DC and AC voltage (depending on sensor)
Frequency and level range	DC to 40 GHz, 100 pW to 30 W (depending on sensor)
Sensors	all R&S®NRV-Z and R&S®URV5-Z voltage and power sensor
Display	LCD for figures, units, user prompting and analog display; adjustable backlighting
Readout	
Absolute	W, dBm, V, dBV, dB μ V
Relative	dB, difference, %, ratio, referenced to a stored reference value or to the second measurement channel; SWR, reflection coefficient, return loss in dB, modulation depth with AM
Numeric display	single-channel display: numeric readout of one channel and display of correction frequency or measurement uncertainty (not with all sensor) or dual-channel display
Analog display	single-channel, automatic or with selectable scale
Resolution of digital display	5 digits max., resolution adjustable in 3 steps: HIGH: 12000 steps or 0.001 dB; MEDIUM: 1200 steps or 0.01 dB; LOW: 120 steps or 0.1 dB
Averaging filter	over 1 to 512 readings for reducing the display noise
Setting	manual or automatic setting depending on measurement range and resolution, see table on page 7
Display noise	see data sheet of sensors
Measurement rate	see table on page 7
Error limits of power readout in W (excluding sensor)	
18 °C to 28 °C	0.013 dB (0.3%) + 1 digit
10 °C to 40 °C	0.035 dB (0.8%) + 1 digit
0 °C to 50 °C	0.057 dB (1.3%) + 1 digit
Zero adjustment	manual or via IEC/IEEE bus, duration approx. 4 s
Frequency response correction	stored frequency response of sensor taken into account by numeric entry of test frequency (manually or via IEC/IEEE bus) or (optionally) by applying a frequency-proportional DC voltage
Attenuation compensation	attenuation or gain connected ahead taken into account; entry of attenuation value (\pm 200 dB) via keyboard or IEC/IEEE bus
Reference value	one reference value per channel for relative measurements: numeric entry via keyboard or IEC/IEEE bus, use of stored measured value or current value of second channel
Reference impedance	for conversion between voltage and power, automatic readout of reference impedance from data memory in sensor or numeric entry via keyboard or IEC/IEEE bus (for RF probe)
Remote control	control of all instrument functions via IEC 625/IEEE 488 interface in line with SCPI; interface functions: SH1, AH1, T6, L4, SR1, RL1, DC1, DT1, PP1
Test generator	
Output power	1.00 mW; factory set to \pm 0.7% (traceable to PTB)
Deviation from nominal	1.2% worst case (0.9 % RSS) at 0 °C to 50 °C for one year
Frequency	50 MHz
SWR	\leq 1.03
RF connector	N female; N male/SMA female adapter for R&S®NRV-Z6/-Z52/-Z15/-Z55 included

I/O Option R&S®NRVD-B2

Analog outputs	two, for simultaneous output of measurement results of both channels
Output impedance	1 k Ω
Voltage range	0 V to 3 V
Resolution	1 mV, deviation from nominal \leq 5 mV
DC input for analog frequency response correction	
Voltage range	\pm 12 V
Input impedance	1 M Ω
Trigger input	TTL, active low
Ready output	TTL, active high

General data

Temperature range	meets EN 60068-2-1/EN 60068-2-2
Operating	0 °C to +50 °C
Storage	-40 °C to +70 °C
Permissible humidity	max. 80%, without condensation
Sinusoidal vibration	5 Hz to 55 Hz, max. 2 g; 55 Hz to 150 Hz, 0.5 g const. (meets EN 60068-2-6, IEC 1010-1 and MIL-T-28800 D, class 5)
Random vibration	10 Hz to 500 Hz, 1.9 g rms
Shock	40 g shock spectrum (in line with MIL-STD-810 D), meets EN 60068-2-27
EMC	meets EMC directive of EU, MIL-STD-461 C, RE 02, CE 03, RS 03, CS 02
Safety	meets EN 61010-1
Power supply	100 V/120 V/220 V \pm 10%, 230 V -6/+15%, 47 Hz to 400 Hz, 25 VA
Dimensions (W x H x D), weight	219 mm x 147 mm x 350 mm, 4.5 kg

Ordering information

Dual-Channel Power Meter	R&S®NRVD	857.8008.02
I/O Option	R&S®NRVD-B2	857.8908.02
Recommended extras		
Rack Adapter	R&S®ZZA-98	827.4533.00
Service Kit	R&S®NRVD-S1	1029.2808.02



ROHDE & SCHWARZ

www.rohde-schwarz.com

Europe: +49 1805 12 4242, customersupport@rohde-schwarz.com
USA and Canada: 1-888-837-8772, customer.support@rsa.rohde-schwarz.com
Asia: +65 65130488, customersupport.asia@rohde-schwarz.com