

PLEASE CHECK WWW.MOLEX.COM FOR LATEST PART INFORMATION

Part Number: [0545974000](#)
Status: **Active**
Overview: Mini Mi II™ Wire Harness
Description: Mini Mi II Connector Position Assurance (CPA) Retainer, 40 Circuits

Documents:

3D Model	Product Specification PS-55659-004-001 (PDF)
Drawing (PDF)	Product Specification PS-55659-005-001 (PDF)
Product Specification PS-54596-007-001 (PDF)	RoHS Certificate of Compliance (PDF)
Product Specification PS-54596-019-001 (PDF)	

General

Product Family	Accessories
Series	54597
Component Type	Connector Position Assurance
Overview	Mini Mi II™ Wire Harness
Product Name	CPA - Conn Pos Assurance, Mini Mi II
UPC	800753281158

Physical

Circuits (Loaded)	40
Circuits (maximum)	40
Color - Resin	Natural
Gender	Female
Material - Resin	Nylon
Net Weight	345.200/mg
Number of Rows	2
Packaging Type	Bag
Temperature Range - Operating	-40° to +105°C

Material Info

Reference - Drawing Numbers

Product Specification	PS-54596-007-001, PS-54596-019-001, PS-55659-004-001, PS-55659-005-001
Sales Drawing	SD-54597-002

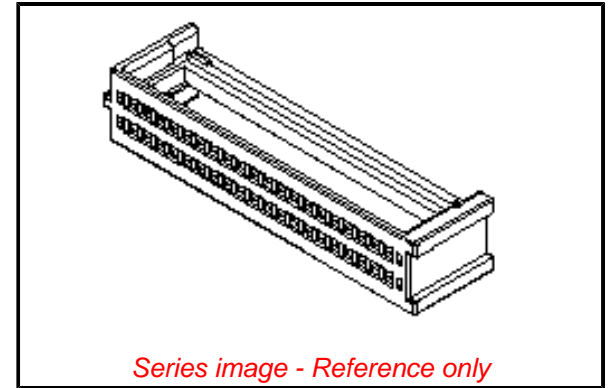

EU ELV

Not Relevant

EU RoHS

Compliant

REACH SVHC

Not Contained Per -
ED/61/2018 (27 June
2018)

Halogen-Free

Status

Not Low-Halogen

Need more information on product environmental compliance?

Email productcompliance@molex.com
Please visit the [Contact Us](#) section for any non-product compliance questions.

China ROHS

ELV

RoHS Phthalates

Green Image

Not Relevant

Not Contained

Search Parts in this Series

[54597](#) Series

Use With

[54596](#)