

PLEASE CHECK WWW.MOLEX.COM FOR LATEST PART INFORMATION

Part Number: [0545602601](#)
Status: **Planned for Obsolescence**
Overview: [qf50](#)
Description: 2.54mm (0.100") Pitch QF-50™ Flat Ribbon Cable Receptacle Upper Housing, 26 Circuits

Documents:

[3D Model](#) [Product Specification PS-54559-005 \(PDF\)](#)
[Drawing \(PDF\)](#) [RoHS Certificate of Compliance \(PDF\)](#)
[Product Specification PS-54559-004 \(PDF\)](#)

General

Product Family	Accessories
Series	54560
Application Tooling Part Link	572525000
Application Tooling Part Link	572527000
Component Type	Housing
Overview	qf50
Product Name	QF-50™

Physical

Circuits (Loaded)	26
Color - Resin	Black
Material - Resin	Polyester
Number of Rows	2
Packaging Type	Tray
Temperature Range - Operating	-40°C to +85°C

Electrical

Current - Maximum per Contact	1A
-------------------------------	----

Material Info

Reference - Drawing Numbers

Product Specification	PS-54559-004, PS-54559-005, RPS-54559-008, RPS-54559-010, RPS-54559-012, RPS-54559-014, RPS-54559-015, RPS-54559-016, RPS-54559-017
Sales Drawing	SD-54560-002, SD-54561-002

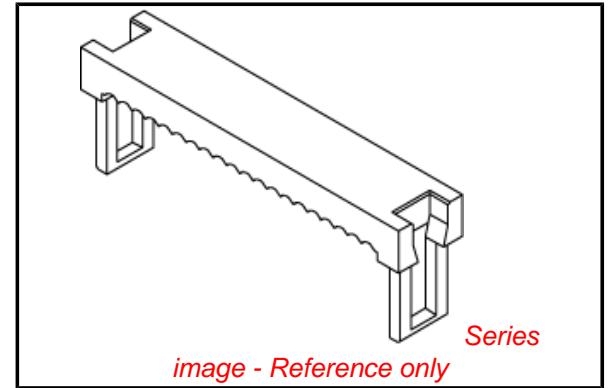

EU RoHS

ELV and RoHS Compliant
REACH SVHC Contains SVHC: No
Low-Halogen Status
Not Low-Halogen

China RoHS



Need more information on product environmental compliance?

Email productcompliance@molex.com
 For a multiple part number RoHS Certificate of Compliance, [click here](#)

Please visit the [Contact Us](#) section for any non-product compliance questions.

Search Parts in this Series

[54560Series](#)

Use With

[54561 Strain Relief](#), [54559 Receptacle Housing](#)

Application Tooling | FAQ

Tooling specifications and manuals are found by selecting the products below. Crimp Height Specifications are then contained in the Application Tooling Specification document.

Japan

Description	Product #
IDT Hand Tool	0572525000
Assembly For MIL Connector	
IDT Machine For MIL	0572527000
IDT Connector	