

DWG. NO. SD-53358-***1*

MM DIMENSIONS IN METRIC DO NOT SCALE DRAWING

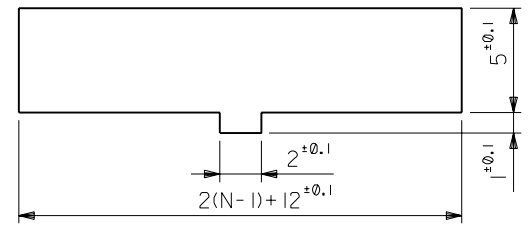
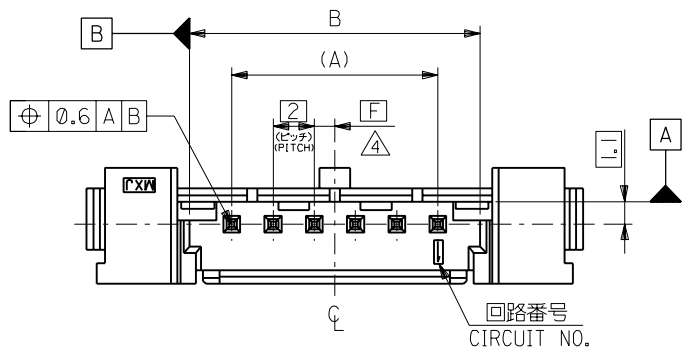

参考パネルスロット寸法
PANEL SLOT DIM.(REF.)
(パネル厚: 0.8~2.0)
(THICKNESS : 0.8-2.0)

注記
NOTES

- 材料 MATERIAL
ウエハー : PBT,UL94V-0
WAFER : PBT,UL94V-0
ピン : 黄銅, スズメッキ(φ0.5)
PIN : BRASS, TIN PLATED (0.5 SQUARE)
- 適合圧着ハウジング : 51090-***00
MATING CRIMP RECEPTACLE HOUSING:51090-***00
- 適合圧接ハウジング : 52484-***1*
MATING IDT RECEPTACLE HOUSING:52484-***1*
- △ B寸法のφから、隣接するピンのφまでの位置を示す。
THIS DIMENSION SHOWS SPACING BETWEEN CENTER OF PIN AND CENTER OF B DIMENSION.
- 本図は、6極を示す。
6 CIRCUIT VERSION IS SHOWN IN THIS DRAWING.
- ハウジングは、パネル打抜き側から挿入すること。
INSERT HOUSING FROM PUNCH SIDE OF PANEL.
- 色
COLOR 53358-***10: 自然色 (WHITE)
53358-***12: 赤色 (RED)
53358-***13: 黄色 (YELLOW)
53358-***14: 青色 (BLUE)

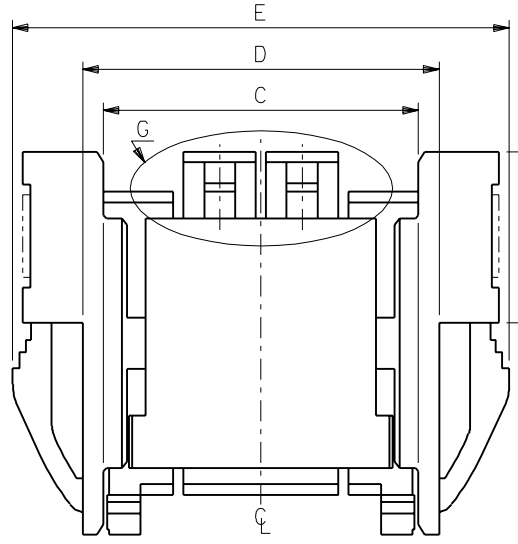

フリクション ロック
FRICTION LOCK

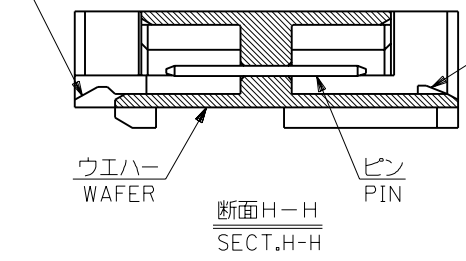

ポジティブ ロック
POSITIVE LOCK

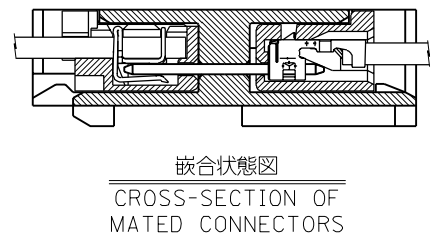

嵌合状態図
CROSS-SECTION OF MATED CONNECTORS

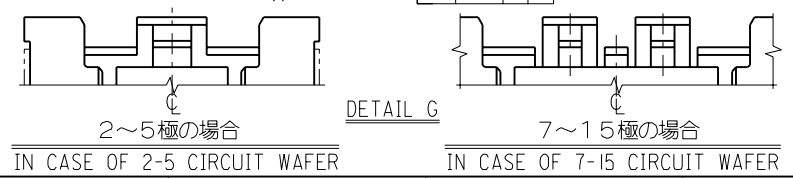
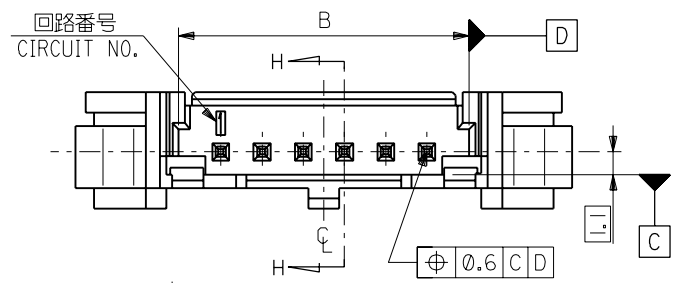

2	42.1	35.3	33.3	32.1	28	53358-151*	15
1	40.1	33.3	31.3	30.1	26	-141*	14
2	38.1	31.3	29.3	28.1	24	4 -131*	13
1	36.1	29.3	27.3	26.1	22	-121*	12
2	34.1	27.3	25.3	24.1	20	-111*	11
1	32.1	25.3	23.3	22.1	18	-101*	10
2	30.1	23.3	21.3	20.1	16	-091*	9
1	28.1	21.3	19.3	18.1	14	-081*	8
2	26.1	19.3	17.3	16.1	12	-071*	7
1	24.1	17.3	15.3	14.1	10	-061*	6
2	22.1	15.3	13.3	12.1	8	-051*	5
1	20.1	13.3	11.3	10.1	6	7 -041*	4
2	18.1	11.3	9.3	8.1	4	-031*	3
1	16.1	9.3	7.3	6.1	2	53358-021*	2
F	E	D	C	B	A	ENG. NO.	CKT.

材料 MATERIAL		注記参照 SEE NOTES		molex MOLEX-JAPAN CO.,LTD. 日本モレックス株式会社	
仕上げ FINISH		---		REVISE ONLY ON CAD SYSTEM	
適用電線範囲 WIRE RANGE		---		TITLE 名称	
被覆外径 INS. RANGE		---		2.0 WIRE TO WIRE CONN. PANEL MOUNT WAFER ASS'Y	
角度 ANGLE	±3°	変更 REVISION	(J2002-1610)	DR. J.M.	02/01/15
30以上 OVER	+0.3	新規作成 RELEASED	(T4027)	S.M.S	04/05/20
10以上 OVER 30未滿 UNDER	+0.25	一般公差 GENERAL TOLERANCES	記号 LTR	変更内容 REVISION RECORD	DR. CHK. 日付 DATE
10未滿 UNDER	+0.2	DRAWN BY 94/05/20 K. Saito		CHK'D BY H. Saito	
APP'D BY (Signature)		尺 度 SCALE		DWG. NO. SD-53358-***1*	
REV A		REV A		REV A	

