

MATERIAL NUMBER	POSITION NUMBER	DIM.'A'	DIM.'B'	DIM.'C'	QUANTITY OF POLARIZING SLOTS	PANEL THICKNESS ACCOMMODATED
439382101	6	20.00 .787	30.90 1.216	41.30 1.626	1	1.80/2.00 .071/.079
439382102	8	30.00 1.181	40.90 1.610	51.30 2.020	2	
439382103	10	40.00 1.575	50.90 2.004	61.30 2.413	2	
439382104	12	50.00 1.968	60.90 2.398	71.30 2.807	2	
439382105	14	60.00 2.362	70.90 2.791	81.30 3.201	2	

- NOTES:
1. MATERIAL: UNFILLED POLYESTER, U.L. 94V-0, COLOR: BLACK
 2. FINISH: NONE
 3. PRODUCT SPECIFICATION: PS-42815-001
 4. PARTS TO BE PACKAGED: 6~10 CKT PER PK-43938-001, 12~14 CKT PER PK-45286-002.
 5. THIS PART IS DESIGNED TO USE MALE CRIMP TERMINAL #42817.
 6. EACH WIRE MUST BE DRESSED SUCH THAT THE TERMINAL MAINTAINS ITS FREE FLOAT WITHIN THE HOUSING.
 7. THIS PART IS DESIGNED TO USE T.P.A. #43980.
 8. THIS PART IS DESIGNED TO MATE WITH RECEPTACLE HOUSING #43914.
 9. SEE SHEET 2 FOR PANEL CUT-OUT DETAILS.
 10. POLARIZING SLOTS TO BE LOCATED BETWEEN CIRCUITS ON EITHER END OF HOUSING OF THE CIRCUIT 1 ROW AS SHOWN.
EXCEPTION: THE 6 CIRCUIT HOUSING WILL HAVE A SINGLE SLOT ON THE CIRCUIT 1 END ONLY.

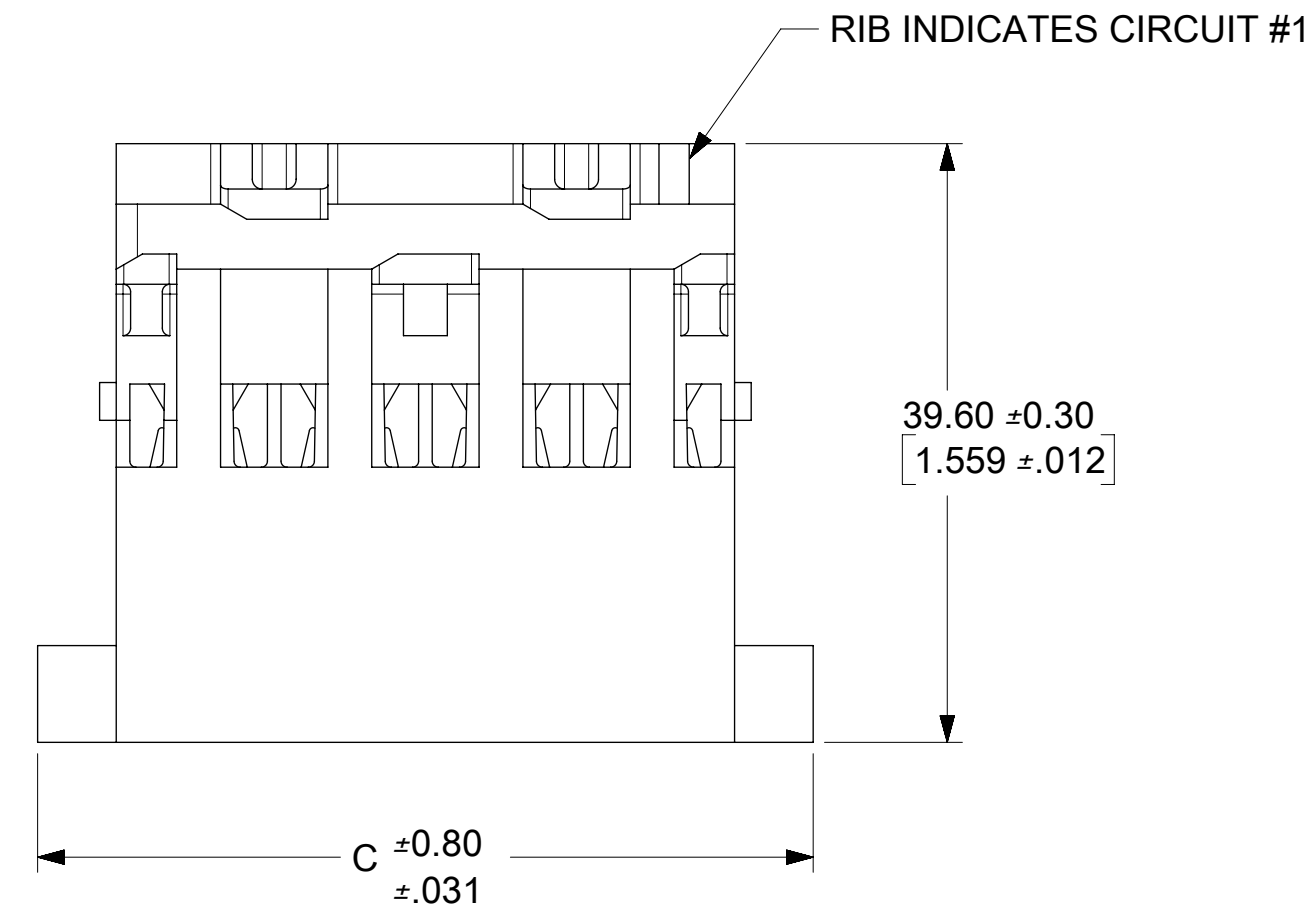

THIS PRODUCT MUST NOT BE USED WITHOUT THE T.P.A.

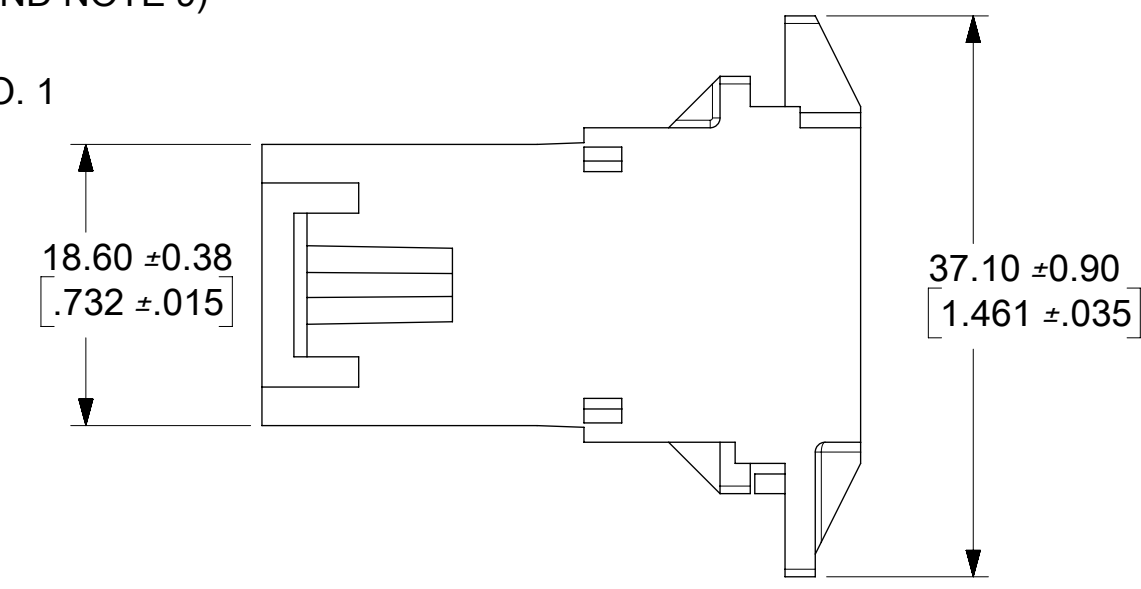
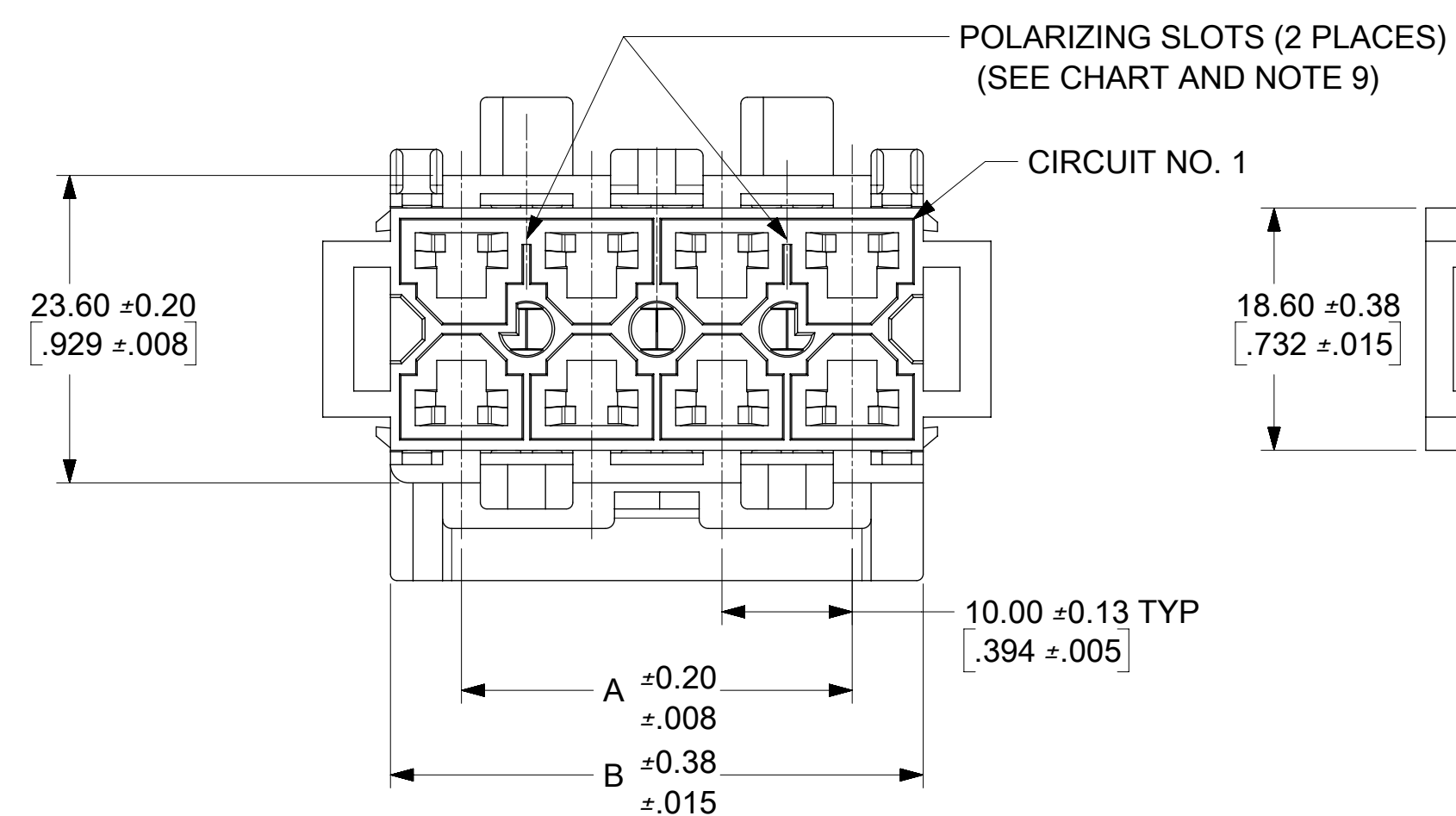
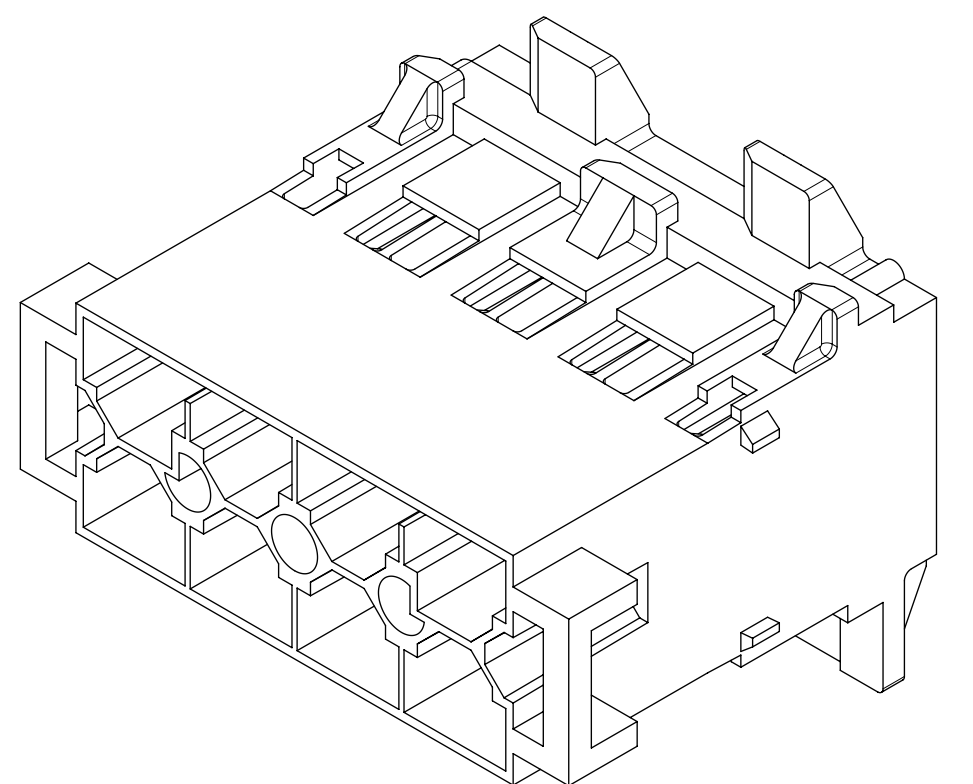

THIS DRAWING CONTAINS INFORMATION THAT IS PROPRIETARY TO MOLEX ELECTRONIC TECHNOLOGIES, LLC AND SHOULD NOT BE USED WITHOUT WRITTEN PERMISSION													
DIMENSION UNITS		SCALE		CURRENT REV DESC: MIGRATED TO ECTR									
MM/IN		2:1		<p>DUAL ROW PANEL MT, PLUG 6-14 CKT., MINI-FIT SR. SERIES</p> <p>PRODUCT CUSTOMER DRAWING</p>									
GENERAL TOLERANCES (UNLESS SPECIFIED)										EC NO: 611033		2018/11/14	
4 PLACES ±		±								DRWN: ME		2019/01/25	
3 PLACES ±		±								CHK'D: MKAMATHMARAK		2019/02/08	
2 PLACES ±		±								APPR: ISHWARG		2019/02/08	
1 PLACE ±		±								INITIAL REVISION:			
0 PLACES ±		±		DRWN: POLGAR		1998/08/21							
ANGULAR TOL ± 0.5 °		± 0.5 °		APPR: COMERCI		1998/10/02							
DRAFT WHERE APPLICABLE MUST REMAIN WITHIN DIMENSIONS				THIRD ANGLE PROJECTION		DRAWING		SERIES					
						C-SIZE		43938					
DOCUMENT NUMBER		DOC TYPE		DOC PART		REVISION							
SD-43938-002		PSD		001		E2							
MATERIAL NUMBER		CUSTOMER		SHEET NUMBER									
SEE CHART OF SHEET 1		GENERAL MARKET		1 OF 2									

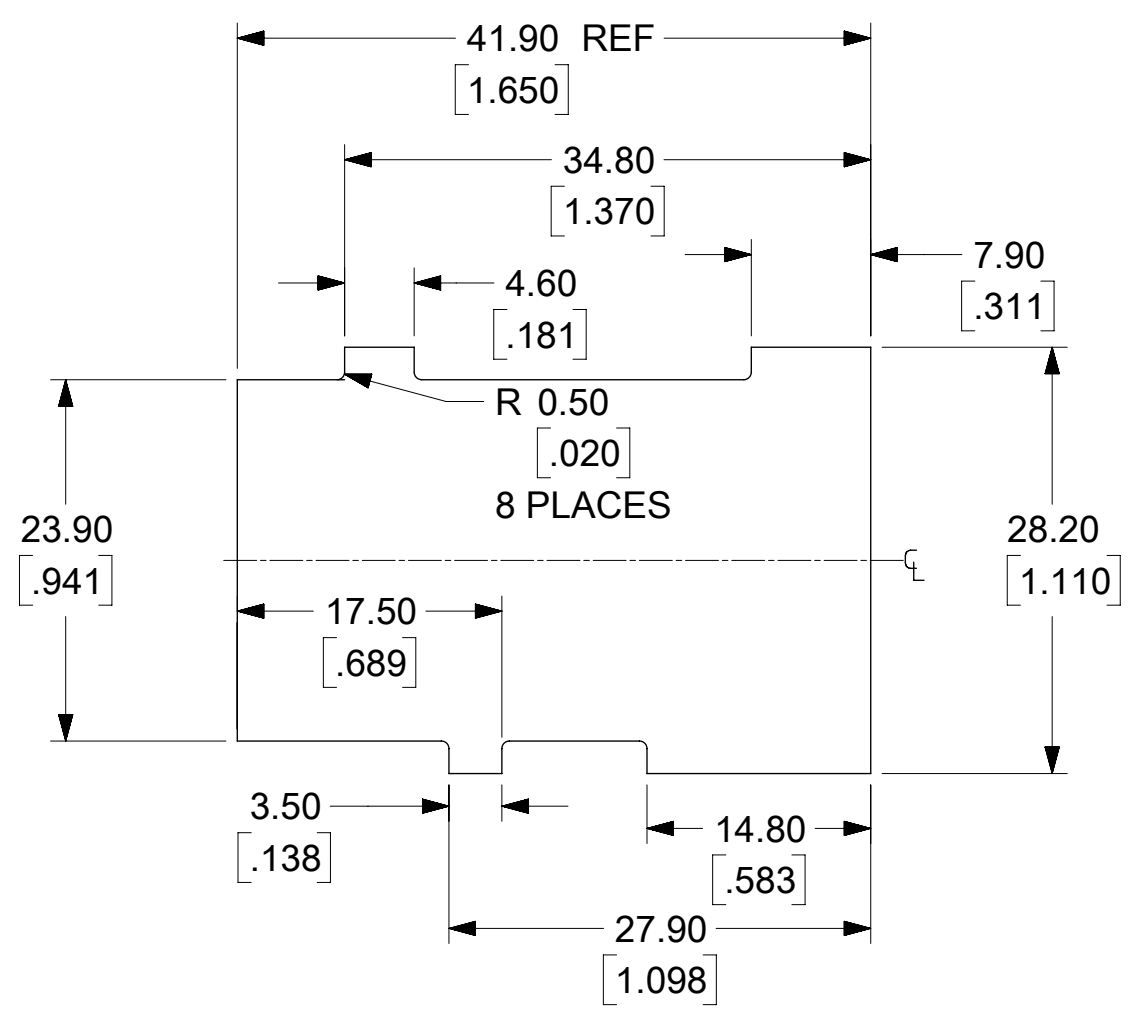

MATERIAL NO.:
43938-2101
6 CIRCUIT

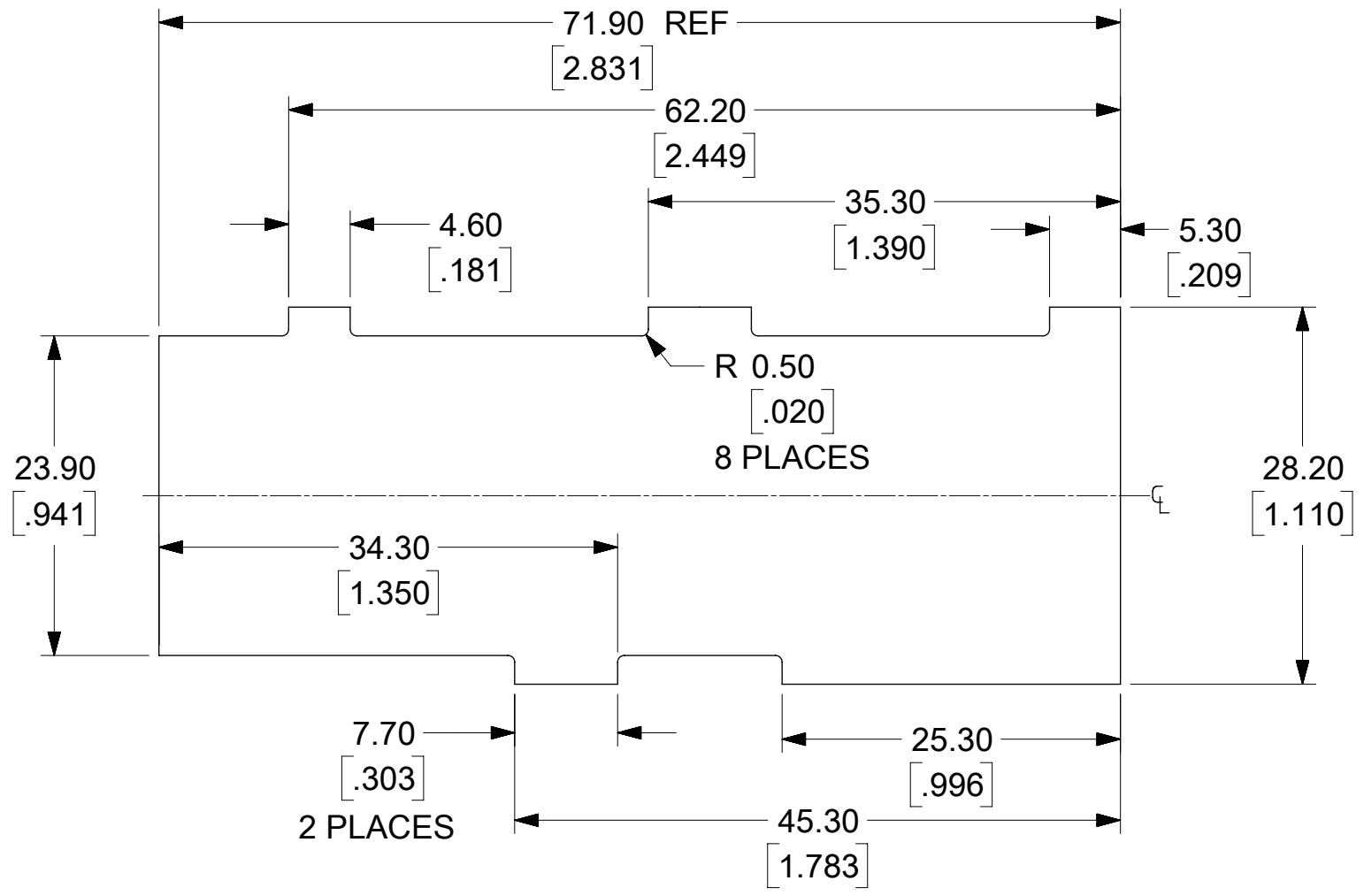

MATERIAL NO.:
43938-2104
12 CIRCUIT

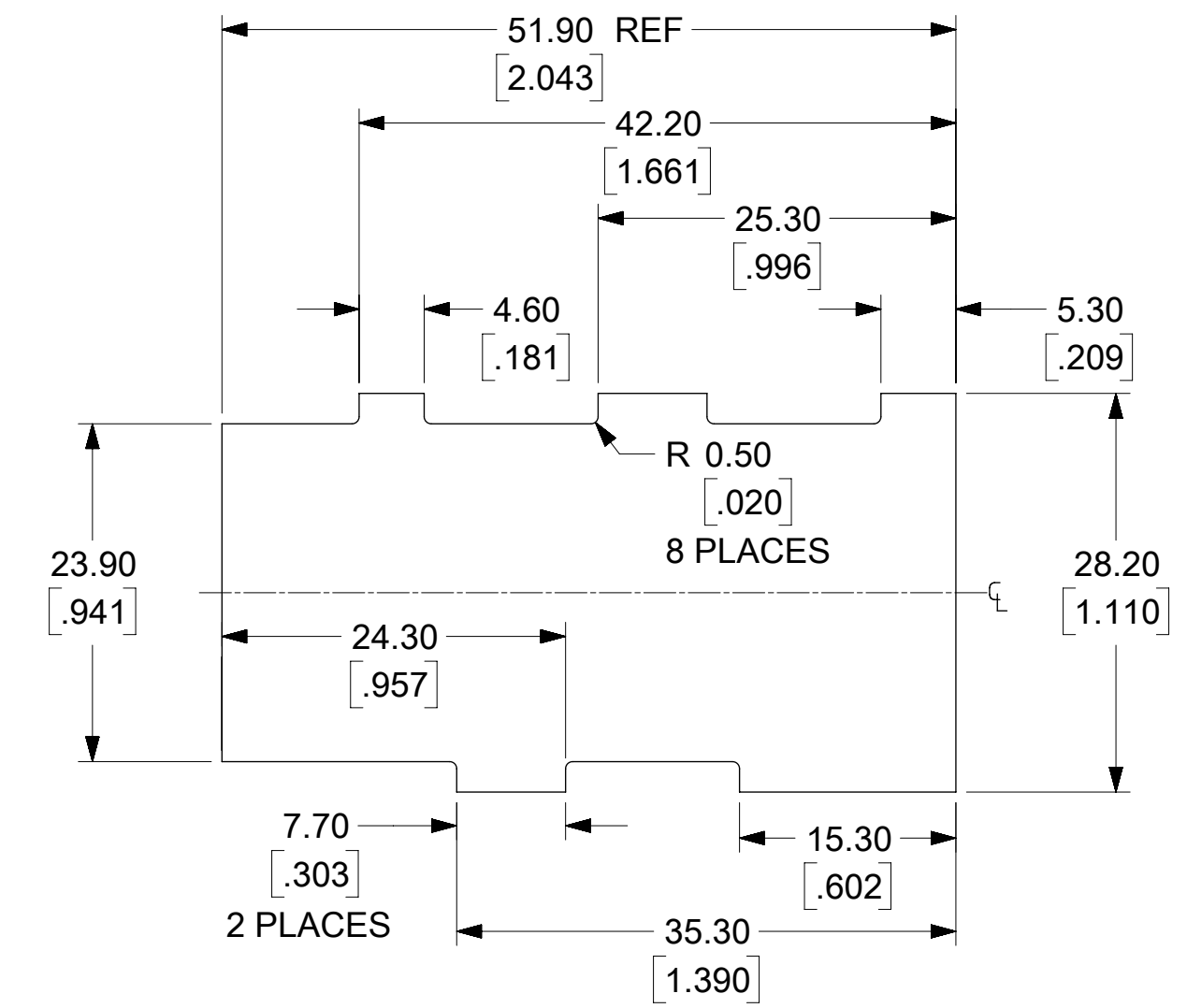

MATERIAL NO.:
43938-1102
43938-2102
8 CIRCUIT

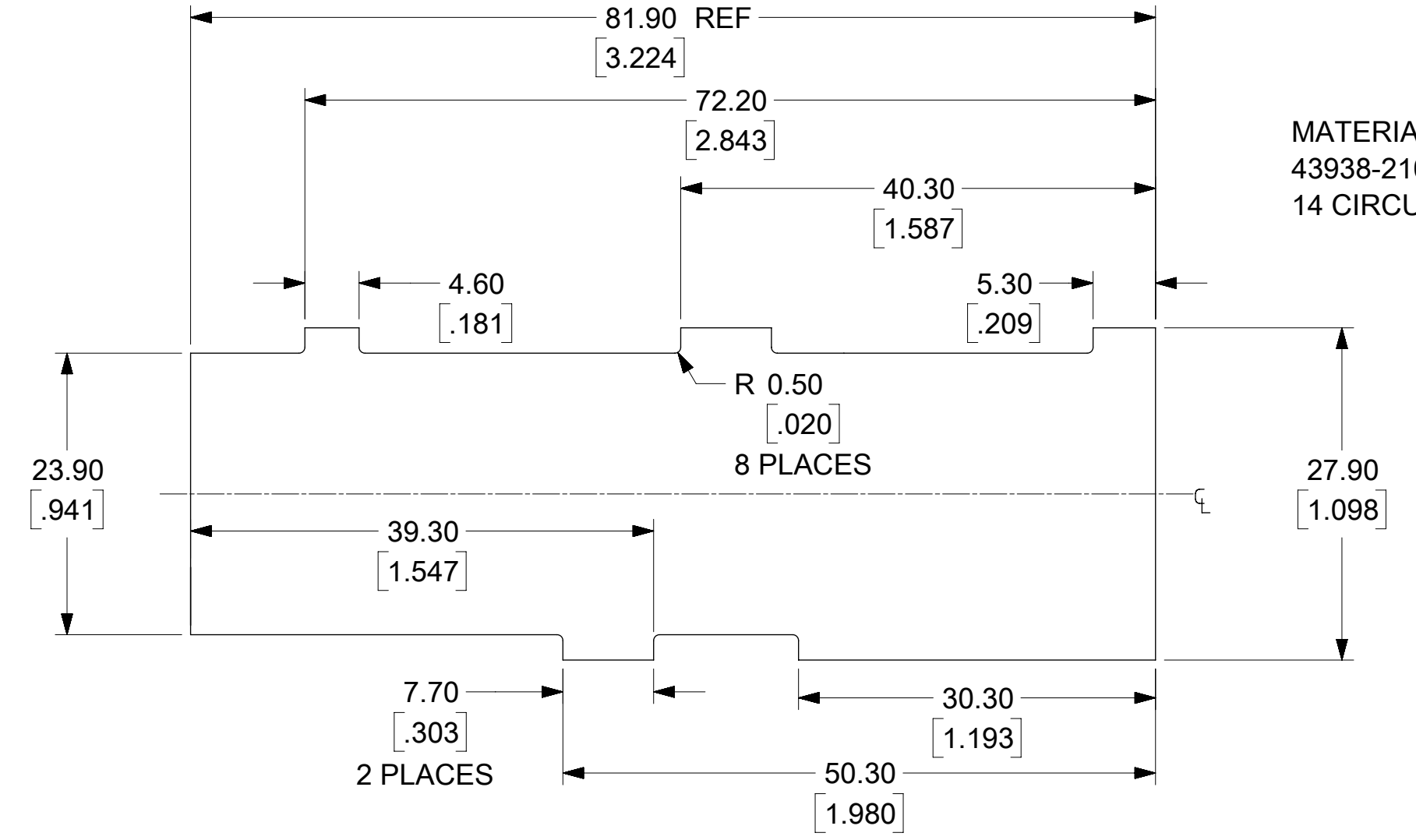

MATERIAL NO.:
43938-2105
14 CIRCUIT

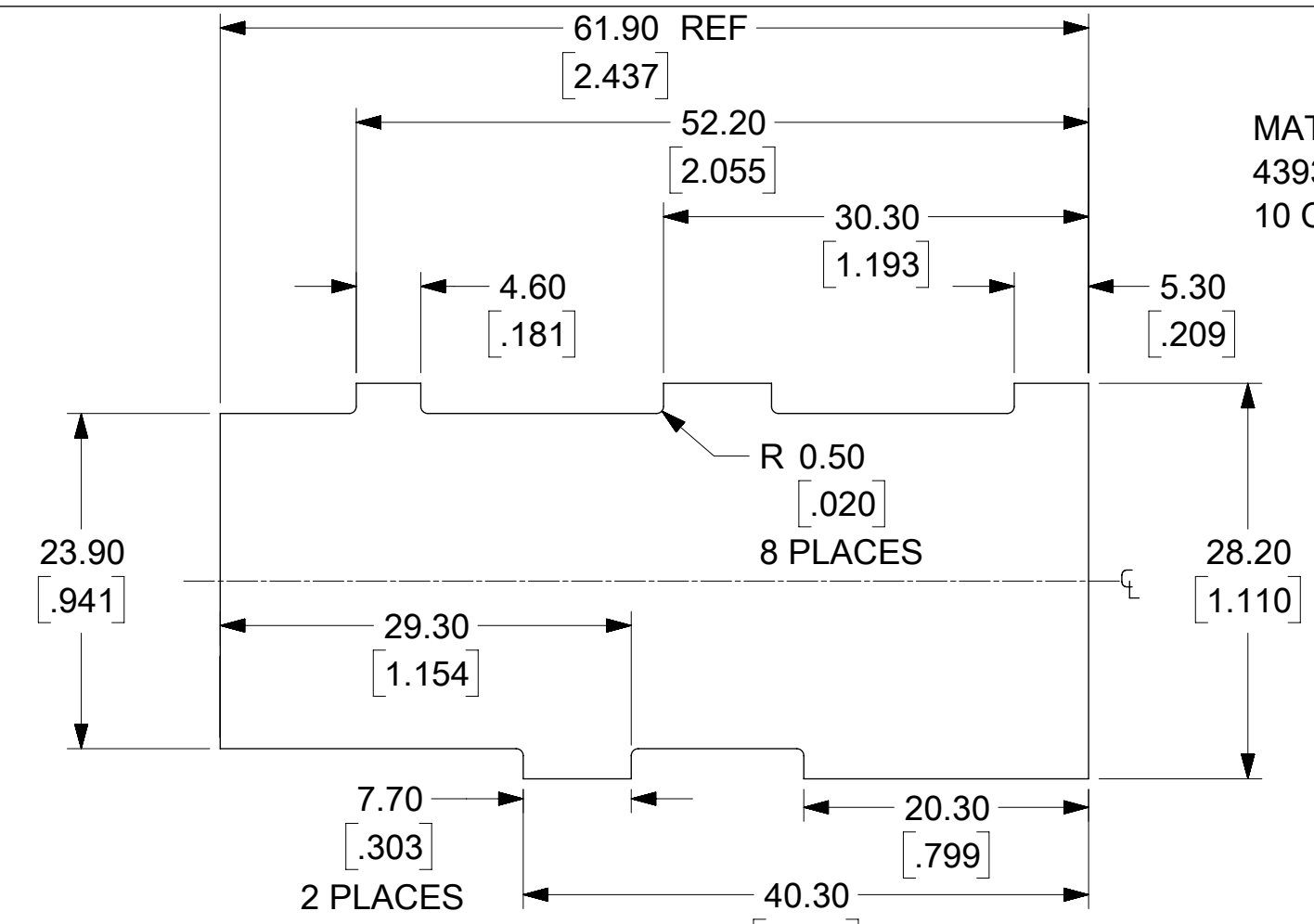

MATERIAL NO.:
43938-2103
10 CIRCUIT

PANEL OPENINGS SHOWN FROM OUTSIDE OF BOX.
SEE CHART FOR PANEL THICKNESS.

THIS DRAWING CONTAINS INFORMATION THAT IS PROPRIETARY TO MOLEX ELECTRONIC TECHNOLOGIES, LLC AND SHOULD NOT BE USED WITHOUT WRITTEN PERMISSION									
DIMENSION UNITS		SCALE		CURRENT REV DESC: MIGRATED TO ECTR					
MM/IN		2:1		<p>molex</p> <p>DUAL ROW PANEL MT, PLUG 6-14 CKT., MINI-FIT SR. SERIES</p> <p>PRODUCT CUSTOMER DRAWING</p> <p>DOCUMENT NUMBER: SD-43938-002 DOC TYPE: PSD DOC PART: 001 REVISION: E2</p> <p>MATERIAL NUMBER: SEE CHART OF SHEET 1 CUSTOMER: GENERAL MARKET SHEET NUMBER: 2 OF 2</p>					
GENERAL TOLERANCES (UNLESS SPECIFIED)									
	MM	INCH							
4 PLACES	±	±							
3 PLACES	±	±							
2 PLACES	±	±							
1 PLACE	±	±							
0 PLACES	±	±							
ANGULAR TOL		± 0.5 °		EC NO: 611033		DRWN: ME		2018/11/14	
DRAFT WHERE APPLICABLE MUST REMAIN WITHIN DIMENSIONS		THIRD ANGLE PROJECTION		CHK'D: MKAMATHMARAK		APPR: ISHWARG		2019/01/25	
		DRAWING		APPR: COMERCI		INITIAL REVISION:		2019/02/08	
		C-SIZE		DRWN: POLGAR		SERIES		1998/08/21	
		43938		APPR: COMERCI		SERIES		1998/10/02	

DOCUMENT STATUS	P1	RELEASE DATE	2019/02/08	09:35:37
-----------------	----	--------------	------------	----------

MATERIAL NUMBER	POSITION NUMBER	DIM. A	DIM. B	DIM. C	QUANTITY OF POLARIZING SLOTS	PANEL THICKNESS ACCOMMODATED
439382201	6	20.00 [.787]	30.90 [1.216]	41.30 [1.626]	1	1.30/1.76 [.051/.069]
439382202	8	30.00 [1.181]	40.90 [1.610]	51.30 [2.020]	2	
439382203	10	40.00 [1.575]	50.90 [2.004]	61.30 [2.413]	2	
439382204	12	50.00 [1.968]	60.90 [2.398]	71.30 [2.807]	2	
439382205	14	60.00 [2.362]	70.90 [2.791]	81.30 [3.201]	2	

NOTES:

1. MATERIAL: UNFILLED POLYESTER, U.L. 94V-0, COLOR: BLACK
2. FINISH: NONE
3. PRODUCT SPEC: PS-42815-001
4. THIS PART IS DESIGNED TO USE MALE CRIMP TERMINAL #42817
5. THIS PART IS DESIGNED TO USE T.P.A. #43980
6. THIS PART IS DESIGNED TO MATE WITH RECEPTACLE HOUSING #43914
7. SEE SHEET 2 FOR PANEL CUT-OUT DETAILS
8. POLARIZING SLOTS TO BE LOCATED BETWEEN CIRCUITS ON EITHER END OF HOUSING OF THE CIRCUIT 1 ROW AS SHOWN.
EXCEPTION: THE 6 CIRCUIT HOUSING WILL HAVE A SINGLE SLOT ON THE CIRCUIT 1 END ONLY
9. AN "X" IS ENGRAVED AS SHOWN TO DESIGNATE THAT THE PART ACCOMMODATES A 1.30/1.76 PANEL THICKNESS
10. PARTS TO BE PACKAGED: 6~10 CKT PER PK-43938-001, 12~14 CKT PER PK-45286-002

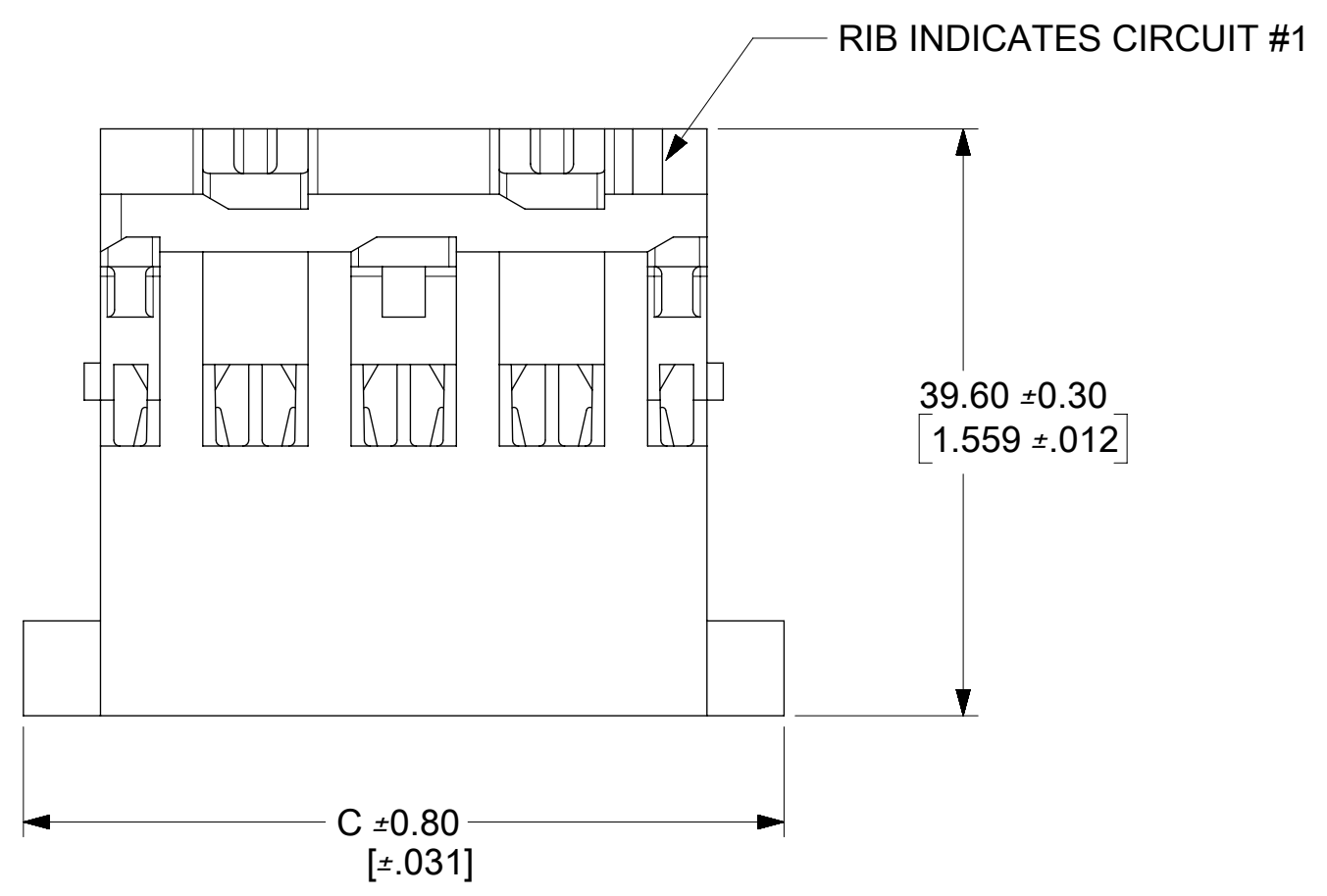

THIS PRODUCT MUST NOT BE USED WITHOUT THE T.P.A.

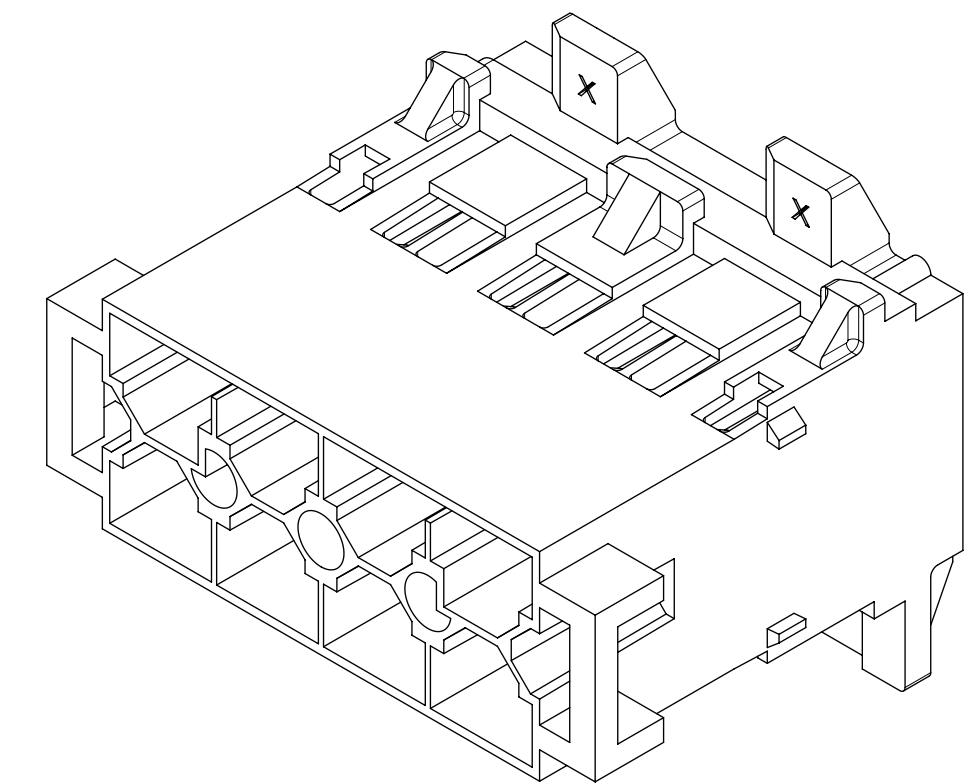
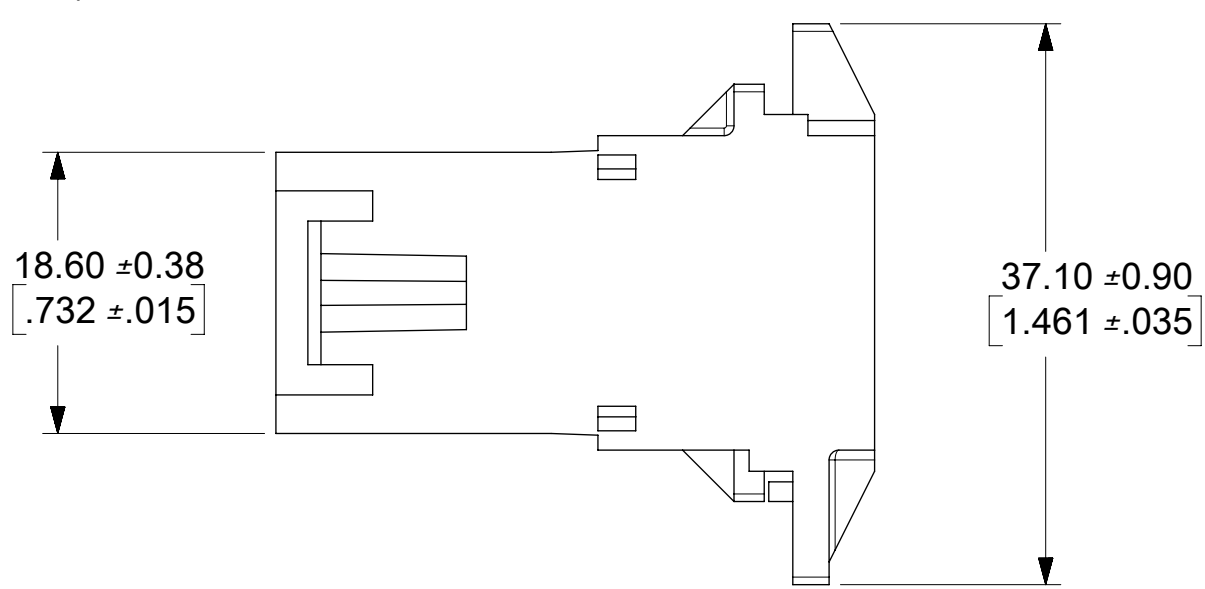
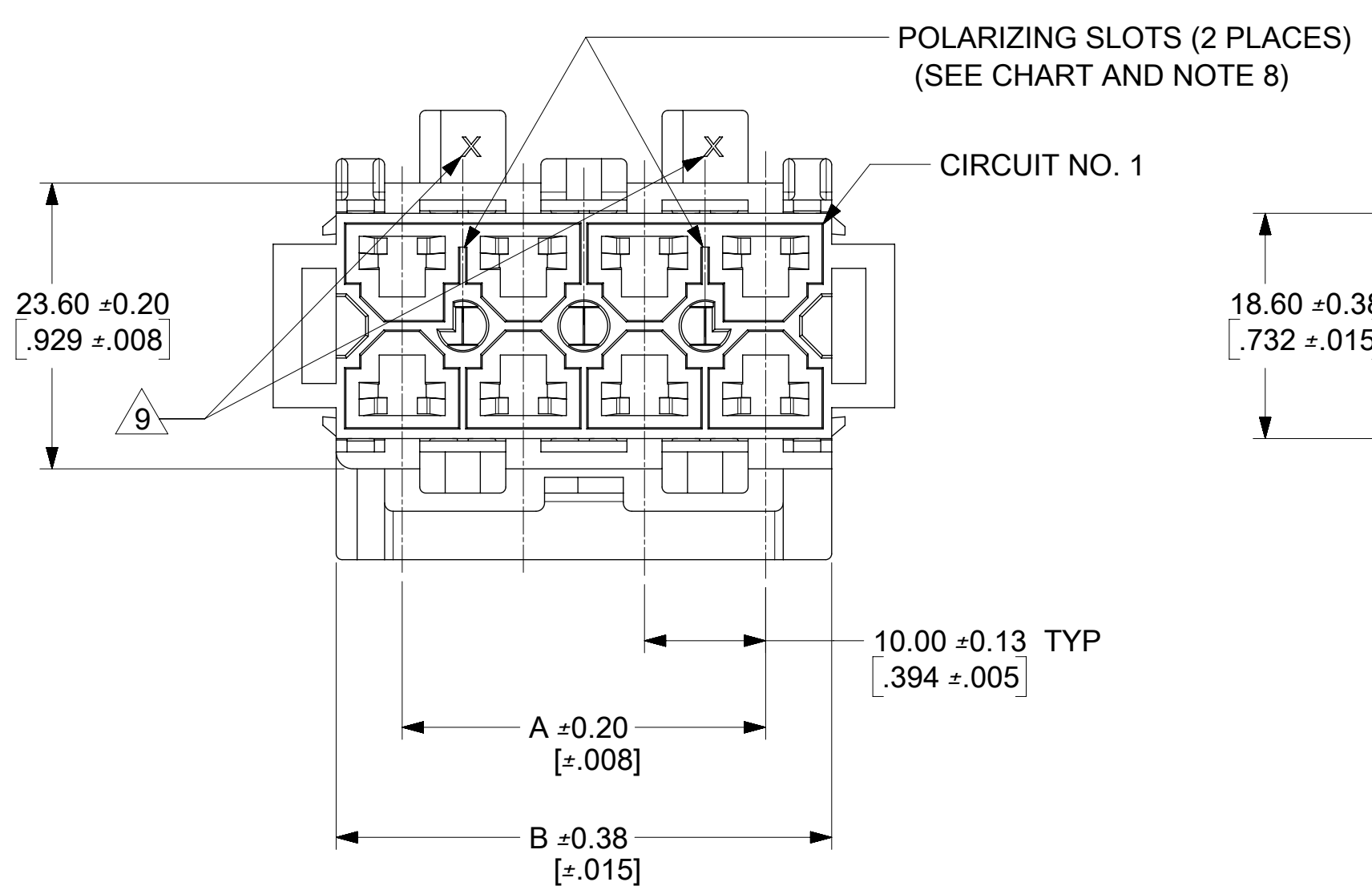

THIS DRAWING CONTAINS INFORMATION THAT IS PROPRIETARY TO MOLEX ELECTRONIC TECHNOLOGIES, LLC AND SHOULD NOT BE USED WITHOUT WRITTEN PERMISSION													
DIMENSION UNITS		SCALE		CURRENT REV DESC: MIGRATED TO ECTR									
IN/MM		2:1		<p>DUAL ROW PANEL MOUNT PLUG, 6-14 CIRCUIT, MINI-FIT SR. SERIES</p> <p>PRODUCT CUSTOMER DRAWING</p>									
GENERAL TOLERANCES (UNLESS SPECIFIED)										EC NO: 171562		2017/10/24	
4 PLACES ±		±								DRWN: RLALSANGI		2018/05/04	
3 PLACES ±		±								CHK'D: ISHWARG		2018/05/04	
2 PLACES ±		±								APPR: ISHWARG		2018/05/04	
1 PLACE ±		±								INITIAL REVISION:			
0 PLACES ±		±		DRWN: JDFOX		2014/08/21							
ANGULAR TOL ± 0.5 °		± 0.5 °		APPR: FSMITH		2014/08/25							
DRAFT WHERE APPLICABLE MUST REMAIN WITHIN DIMENSIONS				THIRD ANGLE PROJECTION		DRAWING		SERIES					
						C-SIZE		43938					
DOCUMENT NUMBER		DOC TYPE		DOC PART		REVISION							
SD-43938-003		PSD		001		B1							
MATERIAL NUMBER		CUSTOMER		SHEET NUMBER									
SEE CHART		GENERAL MARKET		1 OF 2									

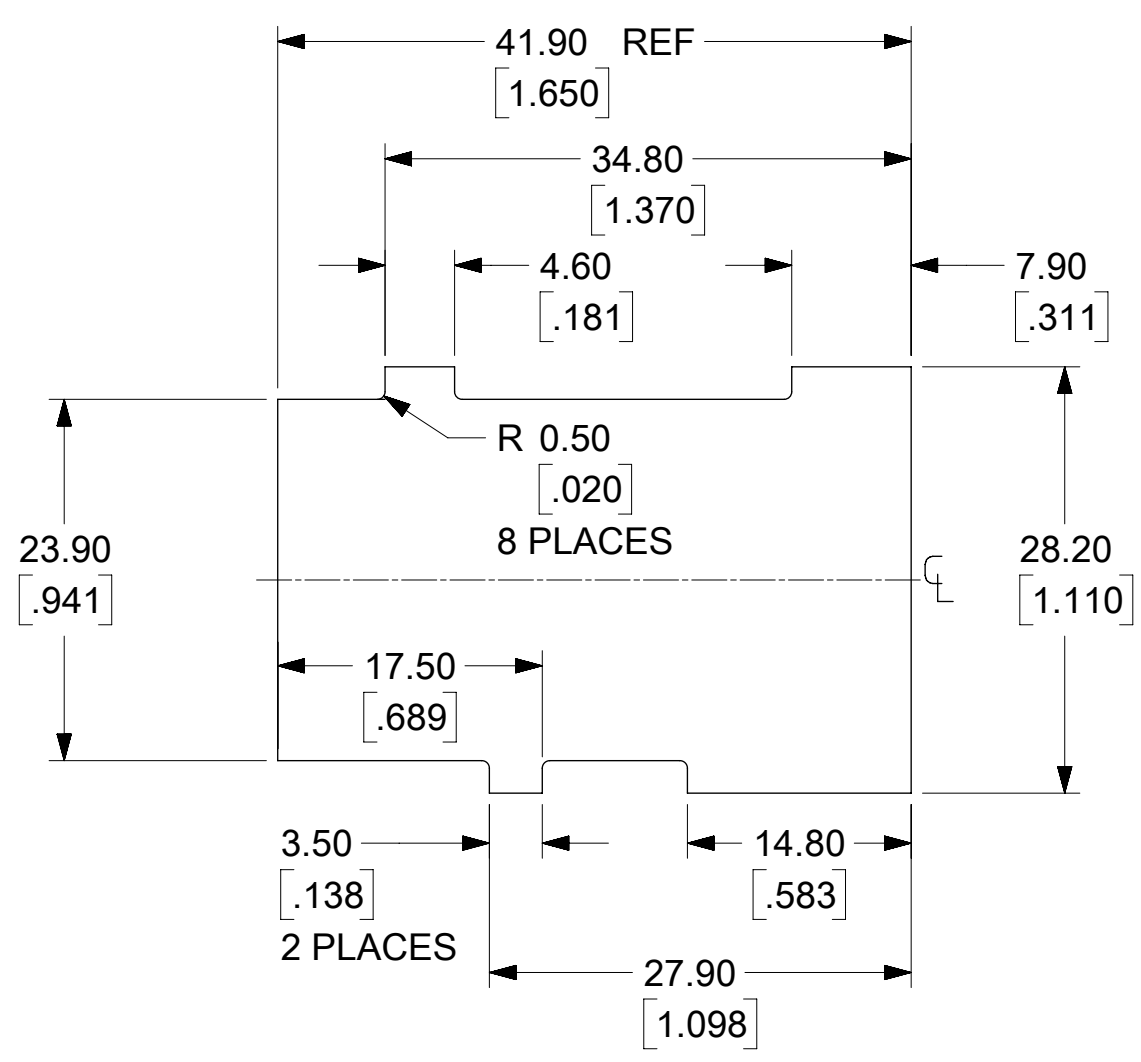

MATERIAL NO.:
439382201
6 CIRCUIT

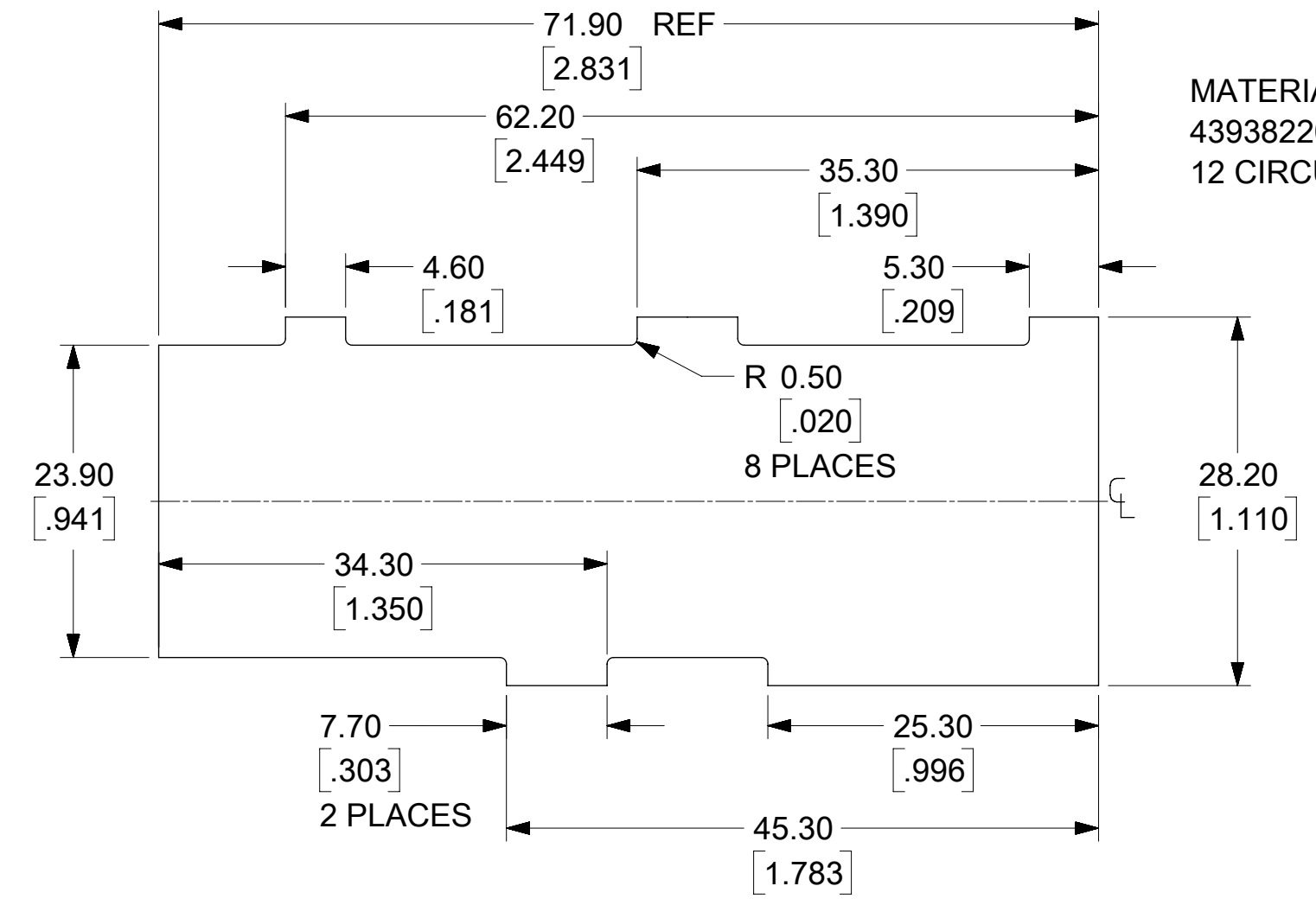

MATERIAL NO.:
439382204
12 CIRCUIT

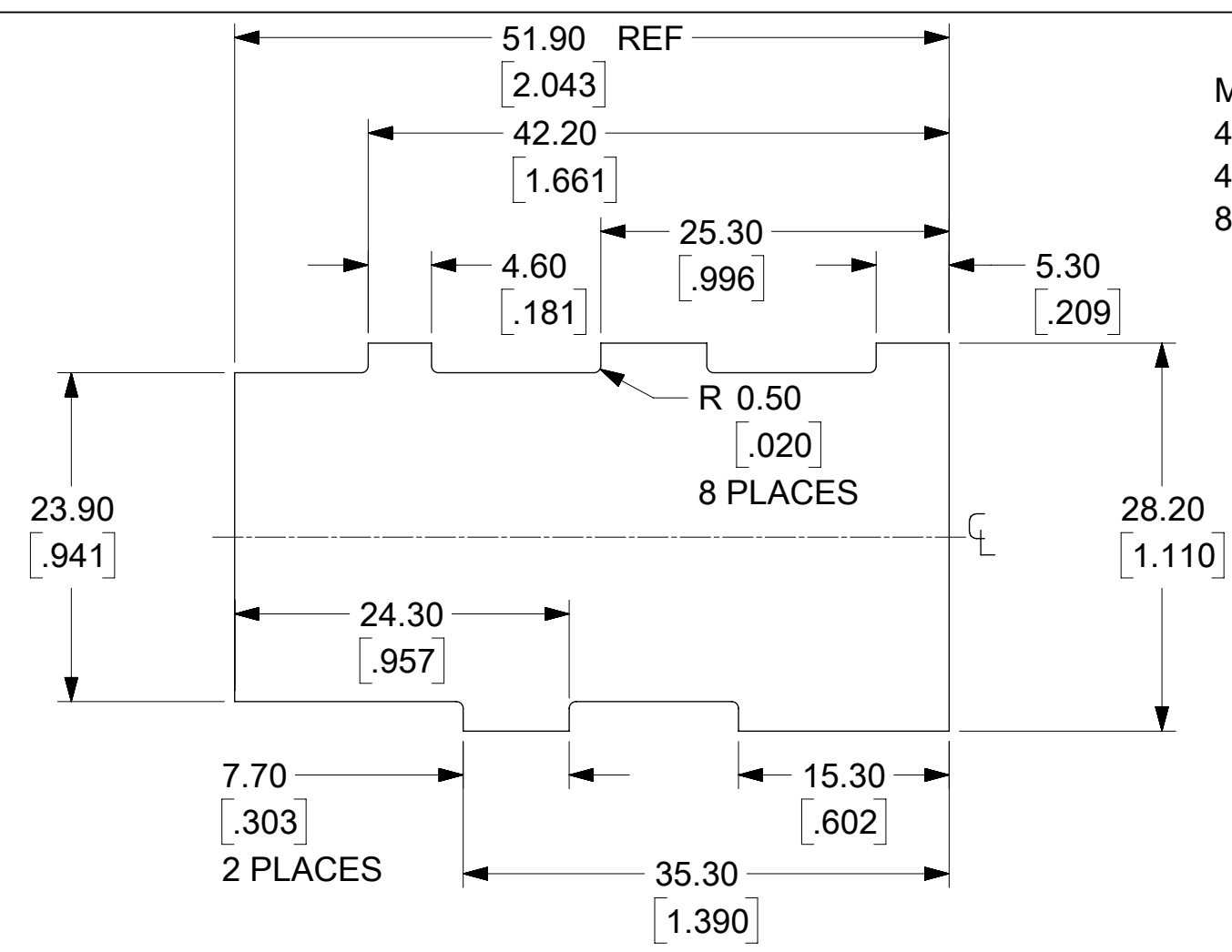

MATERIAL NO.:
439381102
439382202
8 CIRCUIT

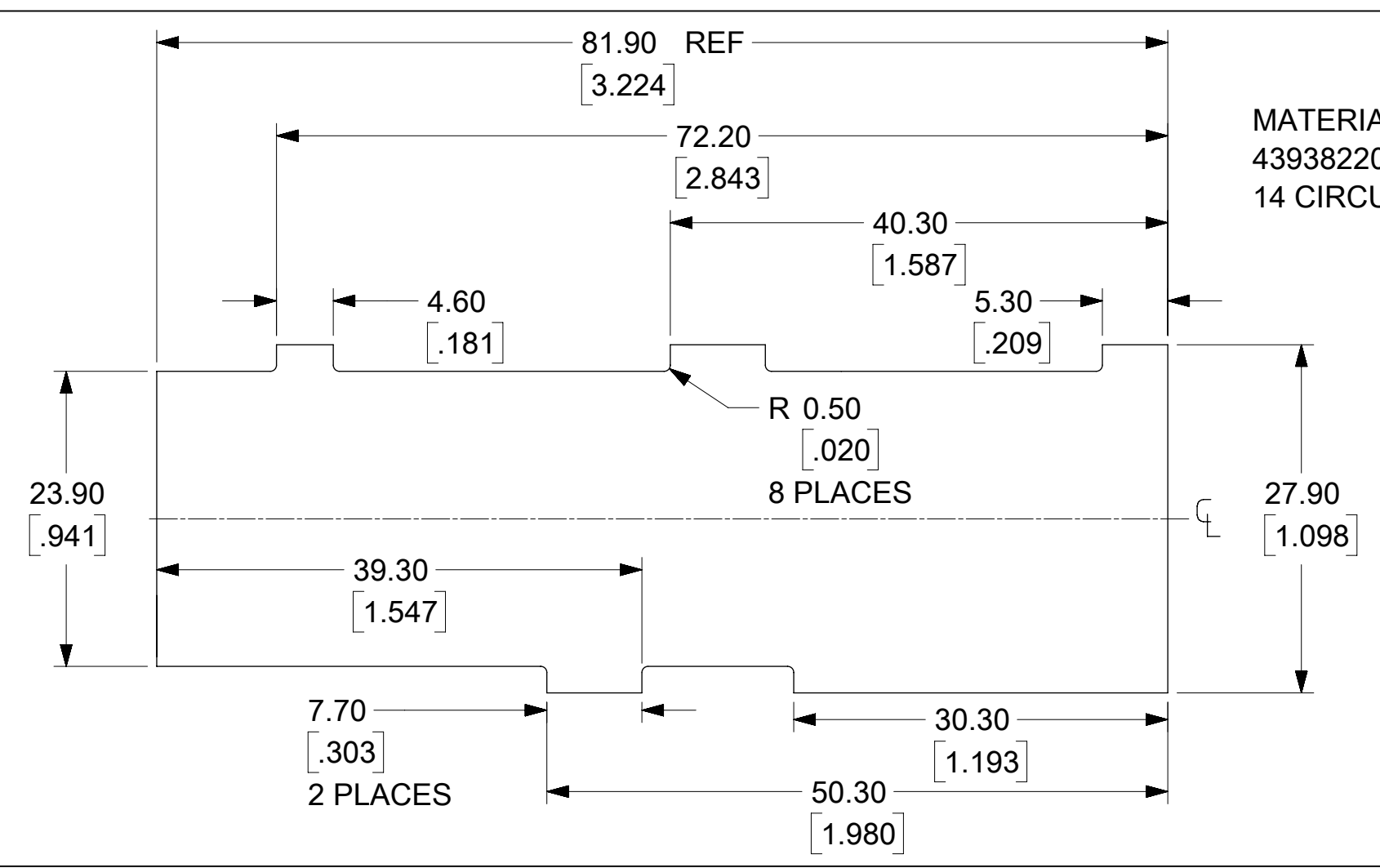

MATERIAL NO.:
439382205
14 CIRCUIT

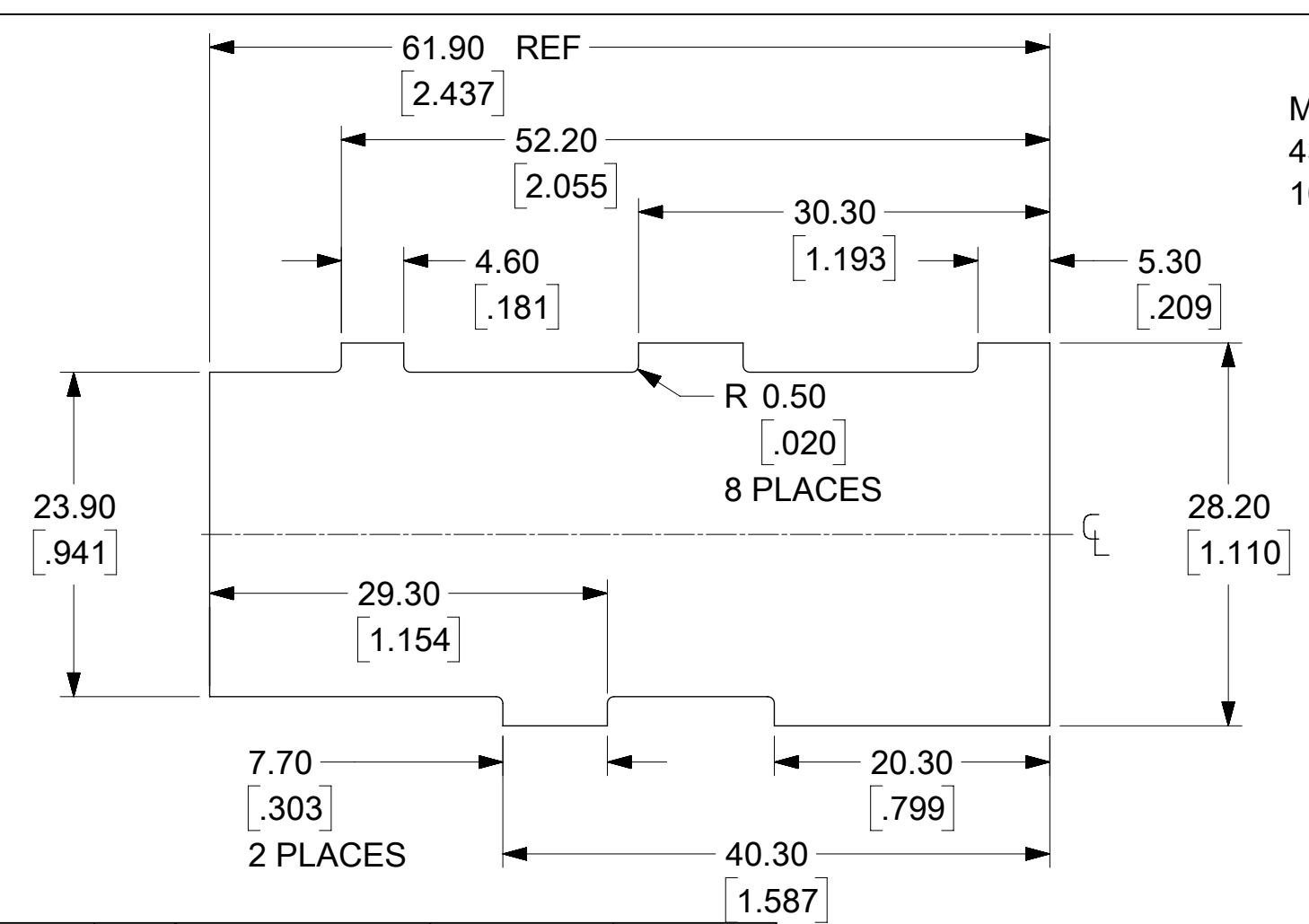

MATERIAL NO.:
439382203
10 CIRCUIT

PANEL OPENINGS SHOWN FROM OUTSIDE OF BOX.
SEE CHART FOR PANEL THICKNESS

THIS DRAWING CONTAINS INFORMATION THAT IS PROPRIETARY TO MOLEX ELECTRONIC TECHNOLOGIES, LLC AND SHOULD NOT BE USED WITHOUT WRITTEN PERMISSION									
DIMENSION UNITS		SCALE		CURRENT REV/DESC: MIGRATED TO ECTR					
IN/MM		2:1		<p>molex</p> <p>DUAL ROW PANEL MOUNT PLUG, 6-14 CIRCUIT, MINI-FIT SR. SERIES</p> <p>PRODUCT CUSTOMER DRAWING</p> <p>DOCUMENT NUMBER: SD-43938-003 DOC TYPE: PSD DOC PART: 001 REVISION: B1</p> <p>MATERIAL NUMBER: SEE CHART CUSTOMER: GENERAL MARKET SHEET NUMBER: 2 OF 2</p>					
GENERAL TOLERANCES (UNLESS SPECIFIED)									
4 PLACES		±	±						
3 PLACES		±	±						
2 PLACES		±	±						
1 PLACE		±	±	EC NO: 171562		2017/10/24			
0 PLACES		±	±	DRWN: RLALSANGI		2018/05/04			
ANGULAR TOL		± 0.5 °		CHK'D: ISHWARG		2018/05/04			
DRAFT WHERE APPLICABLE MUST REMAIN WITHIN DIMENSIONS		THIRD ANGLE PROJECTION		APPR: ISHWARG		2018/05/04			
				INITIAL REVISION:					
				DRWN: JDFOX		2014/08/21			
				APPR: FSMITH		2014/08/25			
				DRAWING		SERIES			
				C-SIZE		43938			

DOCUMENT STATUS	P1	RELEASE DATE	2018/05/04	12:38:16
-----------------	----	--------------	------------	----------