

PLEASE CHECK WWW.MOLEX.COM FOR LATEST PART INFORMATION

Part Number: [0353130560](#)
Status: **Active**
Description: 3.96mm Pitch Header, Vertical, Shrouded, with Positive Lock, 5 Circuits, PA Polyamide (Nylon) 6/6, Glass-filled, Natural

Documents:

3D Model	Product Specification PS-35156-004-001 (PDF)
3D Model (PDF)	Packaging Specification PK-35313-001-001 (PDF)
Drawing (PDF)	RoHS Certificate of Compliance (PDF)

Agency Certification

CSA	LR19980
UL	E29179

General

Product Family	PCB Headers
Series	35313
Application	Power, Wire-to-Board
Product Name	N/A
Taxonomy	PCB Headers and Receptacles
UPC	822348399918

Physical

Breakaway	No
Circuits (Loaded)	5
Circuits (maximum)	5
Color - Resin	Natural
Durability (mating cycles max)	30
First Mate / Last Break	No
Flammability	94V-0
Glow-Wire Capable	No
Guide to Mating Part	No
Keying to Mating Part	None
Lock to Mating Part	Yes
Material - Plating Mating	Tin
Material - Plating Termination	Tin
Material - Resin	Nylon
Net Weight	1.440/g
Number of Rows	1
Orientation	Vertical
PC Tail Length	3.40mm
PCB Locator	No
PCB Retention	None
PCB Thickness - Recommended	1.60mm
Packaging Type	Bag
Pitch - Mating Interface	3.96mm
Pitch - Termination Interface	3.96mm
Plating min - Mating	5.080µm
Plating min - Termination	5.080µm
Polarized to Mating Part	Yes
Polarized to PCB	No
Shrouded	Partial
Stackable	No
Temperature Range - Operating	-40° to +105°C
Termination Interface: Style	Through Hole

Electrical

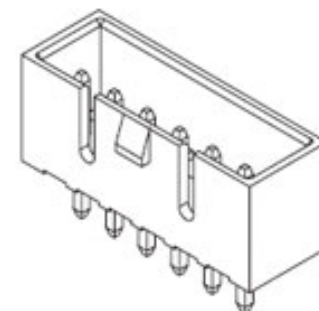

Series image - Reference only

EU ELV

Not Relevant

EU RoHS

Compliant

REACH SVHC

Not Contained Per -
D(2022)4187-DC (10
June 2022)

Halogen-Free

Status

Not Low-Halogen

For more information, please visit [Contact US](#)

China ROHS

ELV

RoHS Phthalates

China RoHS

Green Image

Not Relevant

Not Contained

Search Parts in this Series

[35313](#) Series

Mates With

[35156](#) Wire-to-Board Housing

Current - Maximum per Contact 7.0A
Voltage - Maximum 250V

Material Info

Reference - Drawing Numbers

Packaging Specification PK-35313-001-001
Product Specification PS-35156-004-001

This document was generated on 09/01/2022

PLEASE CHECK WWW.MOLEX.COM FOR LATEST PART INFORMATION