



UK
CA
CE

VEGA74

User manual



TABLE OF CONTENTS

- 1. PRECAUTIONS AND SAFETY MEASURES3
 - 1.1. Preliminary instructions..... 3
 - 1.2. During use 4
 - 1.3. After use 4
 - 1.4. Definition of measurement (overvoltage) category 4
- 2. GENERAL DESCRIPTION4
 - 2.1. Foreword5
- 3. PREPARATION FOR USE5
 - 3.1. Initial checks 6
 - 3.2. Instrument power supply 6
 - 3.3. Storage 6
- 4. NOMENCLATURE6
 - 4.1. Instrument description 7
 - 4.2. Description of measuring leads 7
 - 4.3. Keyboard description 8
 - 4.4. Display description 8
 - 4.5. Initial screen 8
- 5. GENERAL MENU9
 - 5.1. Instrument settings 9
 - 5.1.1. Language 9
 - 5.1.2. Automatic Power OFF for display and key sound..... 9
 - 5.1.3. Operator name entry 10
 - 5.1.4. System date/time setting 10
 - 5.2. Information 10
- 6. OPERATING INSTRUCTIONS 11
 - 6.1. LEAKAGE: Leakage current measurement and recording 11
 - 6.2. AUX: Measure and recording of ambient parameters 14
 - 6.3. PQA: Measurement and recording of main parameters 17
 - 6.3.1. Connections types 17
 - 6.3.2. General settings 21
 - 6.3.3. Display of measurements 23
 - 6.3.4. Start recording 25
 - 6.4. List of message at display 27
- 7. OPERATIONS WITH THE MEMORY 28
 - 7.1. Saving measurements 28
 - 7.1.1. Saving snapshots 28
 - 7.1.2. Recalling and deleting snapshots 29
 - 7.1.3. Recall and delete saved recordings 30
 - 7.1.4. Anomalous situations 31
- 8. CONNECTING THE INSTRUMENT TO A PC 32
- 9. MAINTENANCE 33
 - 9.1. General information 33
 - 9.2. Recharging and replacement of the batteries 33
 - 9.3. Cleaning the instrument 33
 - 9.4. End of life 33
- 10. TECHNICAL SPECIFICATIONS 33
 - 10.1. Technical characteristics AUX AND LEAKAGE sectionS 34
 - 10.2. Technical characteristics PQA section 34
 - 10.3. Reference guidelines 36
 - 10.4. General characteristics 37
 - 10.5. Environment 37
 - 10.5.1. Environmental conditions for use 37
 - 10.6. Accessories 37

11. SERVICE	37
11.1. Warranty conditions	38
11.2. Service	38
12. THEORETICAL APPENDIXES	38
12.1. Voltage Anomalies.....	39
12.2. Supply voltage unbalance.....	39
12.3. Voltage and current Harmonics	40
12.4. Definitions of powers and power factors	43
12.5. Measuring method: outlines.....	45
12.6. Description of typical configurations.....	46

1. PRECAUTIONS AND SAFETY MEASURES

The instrument is been designed in compliance with directives IEC/EN61557 and IEC/EN61010-1, relevant to electronic measuring instruments. Before and after carrying out measurements, carefully observe the following instructions:

- Do not carry out any voltage or current measurement in humid environments.
- Do not carry out any measurements in case gas, explosive materials or flammables are present, or in dusty environments.
- Avoid any contact with the circuit being measured if no measurements are being carried out.
- Avoid contact with exposed metal parts, with unused measuring probes, etc.
- Do not carry out any measurement in case you find anomalies in the instrument such as deformations, breaks, substance leaks, absence of display on the screen, etc.
- Pay special attention when measuring voltages higher than 25V in special environments (such as construction sites, swimming pools, etc.) and higher than 50V in normal environments, since a risk of electrical shock exists.
- Only use original HT accessories.

The following symbols are used in this manual:



CAUTION: observe the instructions given in this manual; improper use could damage the instrument, its components or create dangerous situations for the operator.



High voltage danger: electrical shock hazard.



Double insulation



AC voltage or current



DC voltage or current



Connection to earth

1.1. PRELIMINARY INSTRUCTIONS

- This instrument has been designed for use in the environmental conditions specified in § 10.5.1. Do not use in different environmental conditions.
- The instrument may be used for measuring and verifying the safety of electrical systems. Do not use on systems exceeding the limit values specified in § 10.4.
- We recommend following the normal safety rules devised to protect the user against dangerous currents and the instrument against incorrect use.
- Only the accessories supplied with the instrument (**in particular the external adapter A0061**) guarantee compliance with safety standards. They must be in good conditions and be replaced with identical models, when necessary.
- Make sure the batteries are correctly installed.
- Before connecting the test leads to the circuit being measured, check that the desired function has been selected

1.2. DURING USE

Please carefully read the following recommendations and instructions:

CAUTION



Failure to comply with the caution notes and/or instructions may damage the instrument and/or its components or be a source of danger for the operator.

- Before changing function, disconnect the test leads from the circuit under test.
- When the instrument is connected to the circuit under test, never touch any terminal, even if unused.
- Avoid measuring resistance if external voltages are present. Even if the instrument is protected, excessive voltage could cause damage.
- While measuring current, place the clamp jaws as far as possible from the conductors not involved in the measurement, as the magnetic field they produce could interfere with the measuring operations and place the conductor as much as possible in the center of the jaws to maximize accuracy.

1.3. AFTER USE

When measurements are completed, turn off the instrument by pressing and holding the **ON/OFF** key for some seconds. If the instrument is not to be used for a long time, remove the batteries and follow the instructions given in § 3.3.

1.4. DEFINITION OF MEASUREMENT (OVERVOLTAGE) CATEGORY

Standard "IEC/EN61010-1: Safety requirements for electrical equipment for measurement, control and laboratory use, Part 1: General requirements" defines what measurement category, commonly called overvoltage category, is. § 6.7.4: Measured circuits, reads: circuits are divided into the following measurement categories:

- **Measurement Category IV** is for measurements performed at the source of a low-voltage installation.
Examples are electricity meters and measurements on primary overcurrent protection devices and ripple control units.
- **Measurement Category III** is for measurements performed on installations inside buildings.
Examples are measurements on distribution boards, circuit breakers, wiring, including cables, bus-bars, junction boxes, switches, socket-outlets in fixed installation, and equipment for industrial use and some other equipment, for example, stationary motors with permanent connection to fixed installation.
- **Measurement Category II** is for measurements performed on circuits directly connected to the low-voltage installation.
Examples are measurements on household appliances, portable tools and similar equipment.
- **Measurement Category I** is for measurements performed on circuits not directly connected to MAINS.
Examples are measurements on circuits not derived from MAINS, and specially protected (internal) MAINS-derived circuits. In the latter case, transient stresses are variable; for that reason, the standard requires that the transient withstand capability of the equipment is made known to the user.

2. GENERAL DESCRIPTION

2.1. FOREWORD

The instrument is equipped with a TFT color LCD display, with capacitive "touch-screen" that can be handled simply with the touch of a finger by the user and is structured with an icon-based menu allowing the direct selection of measurement functions for quick and intuitive use.

The instrument can perform the following tests:

PQA	Real-time measurement and recording of mains parameters, harmonic analysis, voltage anomalies (sags, swells), power/energy consumption in single-phase and three-phase generic systems
AUX	Measurement and recording of environmental parameters (illuminance, air temperature, humidity) by means of optional external probes and DC voltage signals
LEAKAGE	Measurement and recording of leakage current (by means of the optional transducer clamp HT96U)



3. PREPARATION FOR USE

3.1. INITIAL CHECKS

Before shipping, the instrument has been checked from an electric as well as mechanical point of view. All possible precautions have been taken so that the instrument is delivered undamaged. However, we recommend checking it to detect any damage possibly suffered during transport. In case anomalies are found, immediately contact the Dealer. We also recommend checking that the packaging contains all the components indicated in § 10.6. In case of discrepancy, please contact the Dealer. In case the instrument should be returned, please follow the instructions given in § 11.

3.2. INSTRUMENT POWER SUPPLY

The instrument is powered by 6x1.2V NiMH rechargeable batteries type AA LR06 supplied with the instrument or by 6x1.5V alkaline batteries type AA LR06. Rechargeable batteries must be recharged by using the external charger A0061, also provided with the instrument.

The green “” symbol indicates a sufficient charge level for the correct performance of the tests. The red “” symbol indicates an insufficient charge level for the correct performance of the tests. In this case, recharge the batteries (see § 9.2).



CAUTION

- If the external adapter is used, it is necessary to connect it first to the instrument, then to the mains, then please connect the instrument to the circuit to be tested
- While recording it is recommended to use both the external adapter and the rechargeable batteries, in order to guarantee the instrument's supply in case of voltage interruption
- With low battery indication, stop the tests and recharge or replace the batteries (see § 9.2)
- **The instrument is capable of keeping data stored even without batteries**
- The instrument has an AutoPower OFF function (which can be deactivated) after 5 minutes' idling (the Auto Power OFF is inactive while recording – see § 5.1.2)

3.3. STORAGE

In order to guarantee precise measurement, after a long storage time under extreme environmental conditions, wait for the instrument to come back to normal condition (see § 10.5.1).

4. NOMENCLATURE

4.1. INSTRUMENT DESCRIPTION

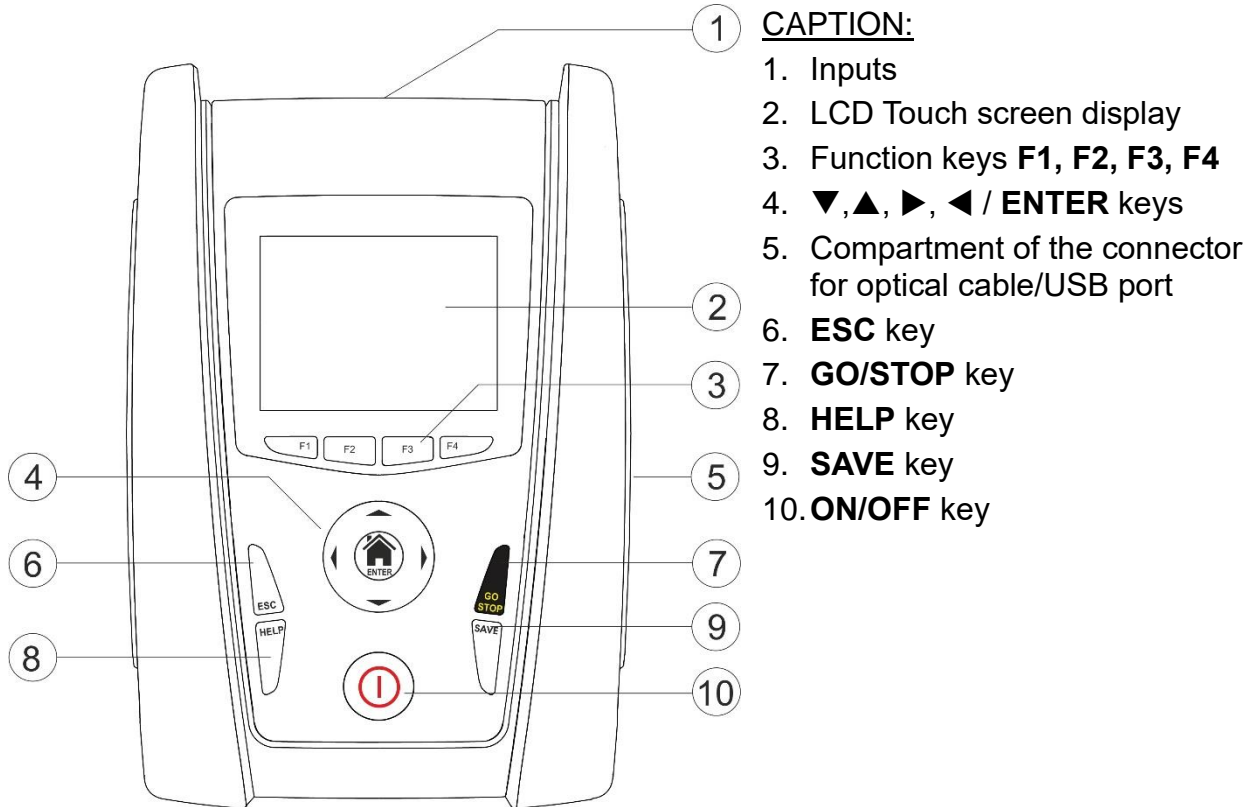

Fig. 1: Description of the front part of the instrument

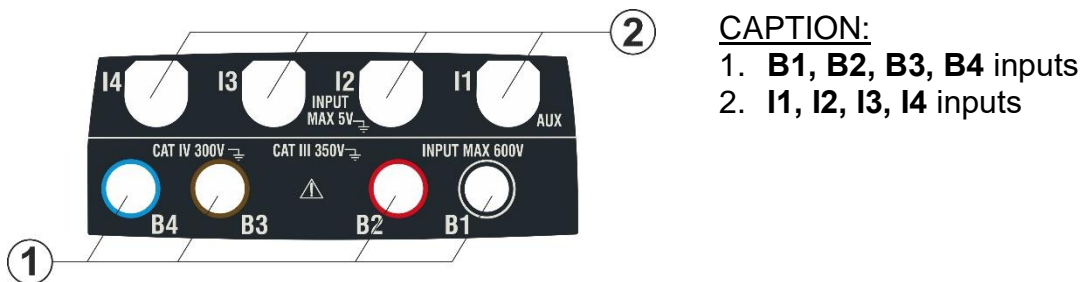

Fig. 2: Description of the upper part of the instrument

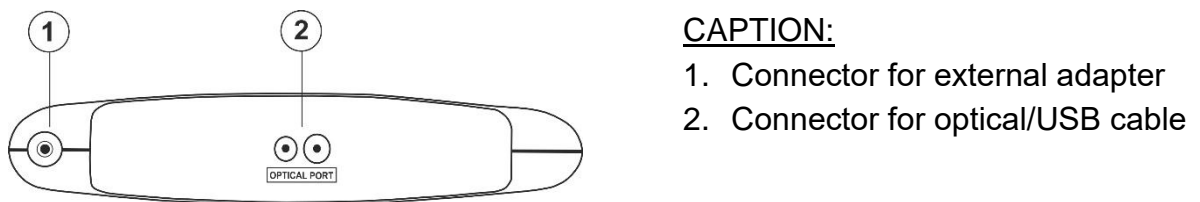

Fig. 3: Description of the instrument's side

4.2. DESCRIPTION OF MEASURING LEADS

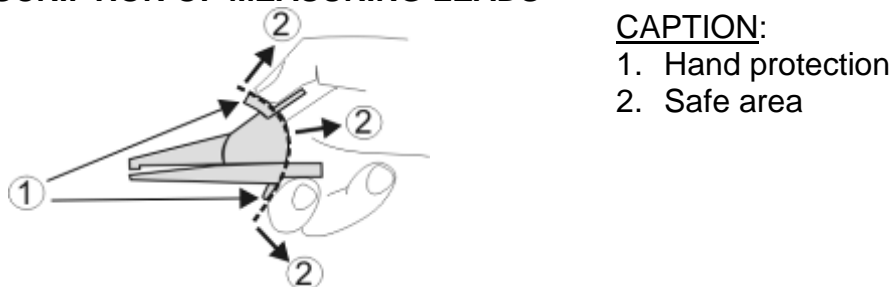

Fig. 4: Description of measuring leads

4.3. KEYBOARD DESCRIPTION

The keyboard includes the following keys:



ON/OFF key to switch on/off the instrument



ESC key to exit the selected menu without confirming



◀ ▶ ▲ ▼ keys to move the cursor through the different screens in order to select the desired programming parameters

HOME 🏠 / **ENTER** key to back to general Menu on each moment



GO/STOP key to start the measurement



SAVE key to save the measured values



HELP key to access the online help and display the possible connections between the instrument and the system for each selected function

F1, F2, F3, F4 Function keys corresponding to the activation of the four icons on the bottom of the screen as an alternative to direct touch on the display

4.4. DISPLAY DESCRIPTION

The display is an LCD, 320x240pxl TFT color display with capacitive touch screen whose icon-structure can be directly selected with a simple touch. The first line of the display indicates the type of active measurement, the date/time and the battery charge indication.

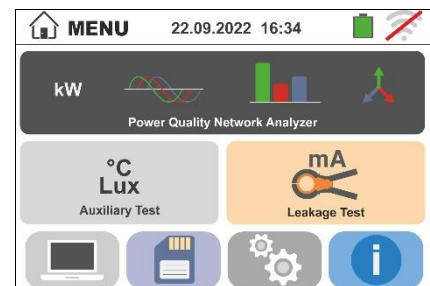

4.5. INITIAL SCREEN

When switching on the instrument, the initial screen appears for a few seconds. It shows:

- The HT manufacturer's logo
- The instrument model
- The Firmware version (LCD and CPU)
- The serial number (SN:) of the instrument
- The date of instrument calibration (Calibration date:)



After a few seconds, the instrument switches to the general menu.

5. GENERAL MENU

Pressing the **ENTER** key in any condition of the instrument allows to go back to the general menu in which internal parameters may be set, the saved measures can be displayed and the desired measuring function may be selected.

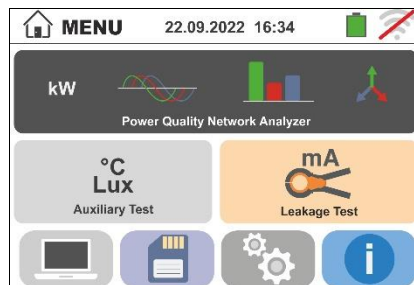
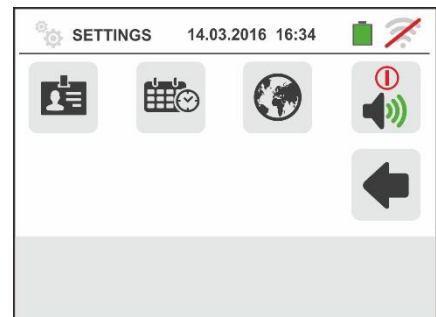

Fig. 5: General menu of the instrument

5.1. INSTRUMENT SETTINGS

Touch the icon. The screen to the side appears on the display. The following settings are available:

- System language setting
- System date/time setting
- Operator name setting
- Activation/deactivation of display AutoPower OFF and of key sound



Settings will be maintained also after switching off the instrument.

5.1.1. Language

Touch the icon to select the system language. The screen to the side appears on the display.

Select the desired language, confirm the choice and return to the previous screen.

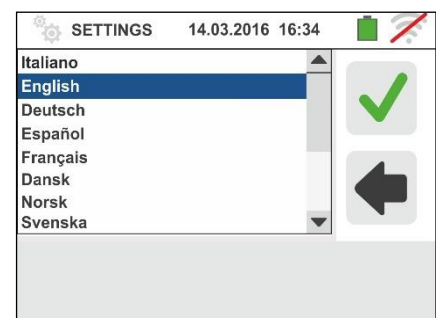

5.1.2. Automatic Power OFF for display and key sound

Touch the icon. The screen to the side appears on the display.

Move the slide bar reference of section "⊘" down/up to turn off/on the Automatic Power OFF of the instrument after a period of inactivity of 5 minutes.

Move the slide bar reference of section "👉" down/up to disable/enable the sound key when pressed. Confirm the choices made and go back to the previous screen.

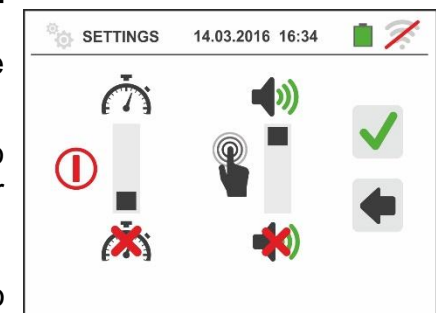

5.1.3. Operator name entry

Touch the icon  to enter the name of the operator that will be displayed in the header of each measurement downloaded to PC. The screen to the side appears on the display.

- Set the desired name using the virtual keyboard (max 12 characters).
- Confirm the settings or exit without saving.

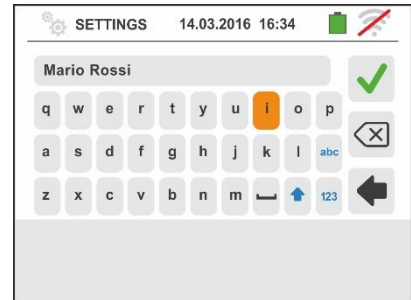

5.1.4. System date/time setting

Touch the icon  to set the system date/time. The screen to the side appears on the display.

Touch the "EU" icon for the European date/time system in the format "DD/MM/YY hh:mm" or the "US" icon for the American system in the format "MM/DD/YY hh:mm AM/PM". Touch the up/down arrow keys to set the desired value. Confirm the settings or exit without saving.

Current date/time is kept inside the instrument without batteries for approximately 12 hours.

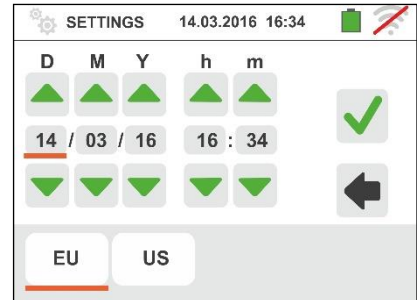

5.2. INFORMATION

Touch the icon . The display shows the screen on the right with the icon relative to the properties of the instrument

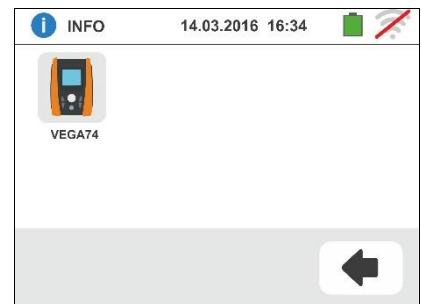

Touch the icon . The display shows the screen on the right as well as following informations:

- Serial number
- Internal version of Firmare and Hardware
- Last calibration date

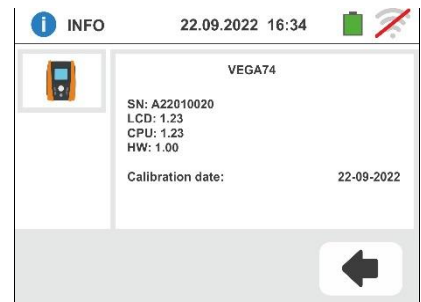

6. OPERATING INSTRUCTIONS

6.1. LEAKAGE: LEAKAGE CURRENT MEASUREMENT AND RECORDING

This function allows measuring and recording the leakage current in single-phase or three-phase systems by means of the optional accessory HT96U clamp.

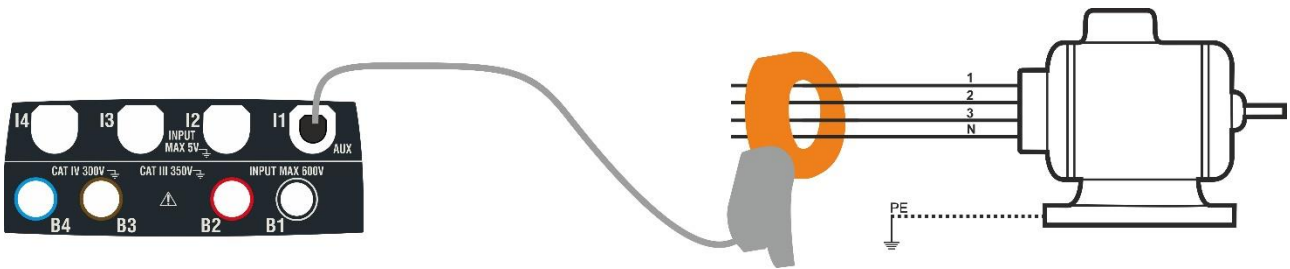

Fig. 6: Indirect measurement of leakage current in three-phase systems

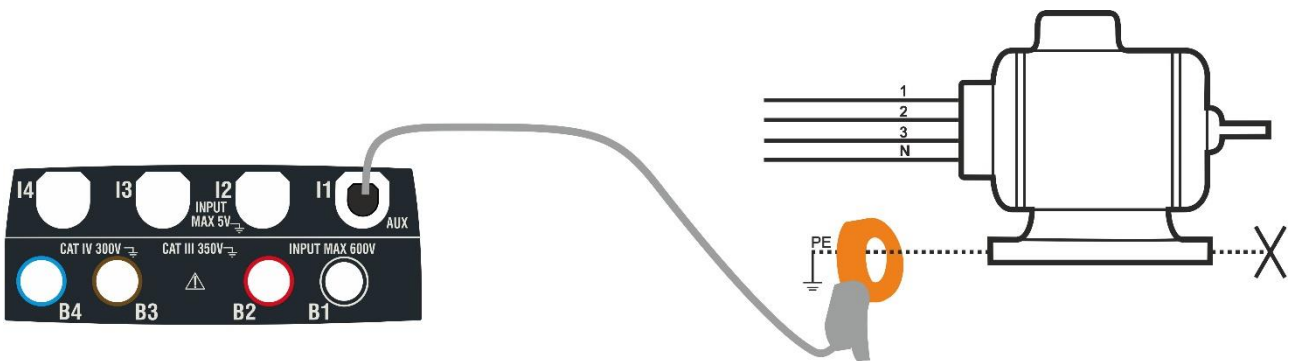

Fig. 7: Direct measurement of leakage current in three-phase systems

1.



Touch the **mA Leakage Test** icon. The screen to the side appears on the display.

Touch the **1A** icon to set the full scale of the used clamp. The following screen appears on the display:

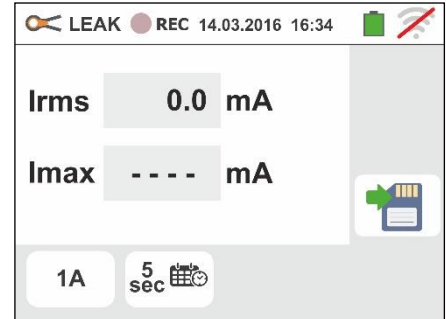

2.

Touch the arrow keys or to set the full scale value of the selected HT96U clamp in the 1A ÷ 3000A range. Press and hold the keys for a quick selection of values

Touch the **5 sec** icon to set recording parameters. The following screen appears on the display

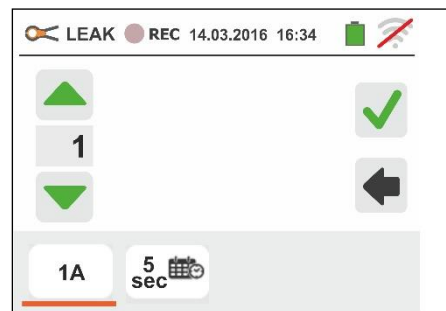

:

- Move the left slide bar cursor in order to select the aggregation time (see § 12.5) among the options: **2s, 5s, 10s, 30s, 1min, 2min, 5min, 10min, 15min, 30min**

Move the central slide bar cursor (“GO” symbol) to the positions:

- → **Manual** start of recording by pressing the **GO/STOP** key (at the next minute after the pressure of key)
- → **Automatic** start of recording at the date/time set by the user (after a preliminary pressure of **GO/STOP** key in order to set the instrument in stand-by mode). **Touch the corresponding field to set the date/time** in the “MM:DD:YY HH:MM” format and confirm

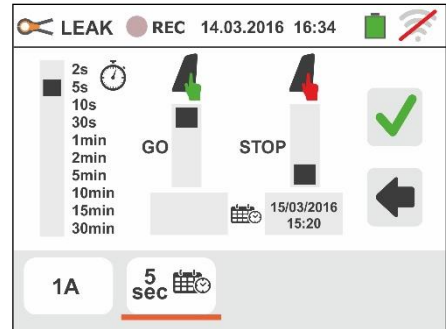

Move the right slide bar cursor (“STOP” symbol) in the positions:

- → **Manual** stop of recording by pressing the **GO/STOP** key
- → **Automatic** stop of recording at the date/time set by the user. **Touch the corresponding field to set the date/time** in the “MM:DD:YY HH:MM” format and confirm

- Insert the external clamp into instrument input **I1**
- For indirect measurements of leakage current, connect the external clamp according to Fig. 6. For direct measurements of leakage current, connect the clamp according to Fig. 7 and disconnect possible additional earth connections that could influence the test results.



CAUTION

Possible additional earth connections could influence the measured value. In case of real difficulty in removing them, we recommend performing the measurement in an indirect way.

- The real time value of the measured leakage current (I_{rms}) and it's maximum value (I_{max}) appears on the display as shown in the screen to the side.

Press the **SAVE** button or touch the icon to save the measurement (see § 7.1).

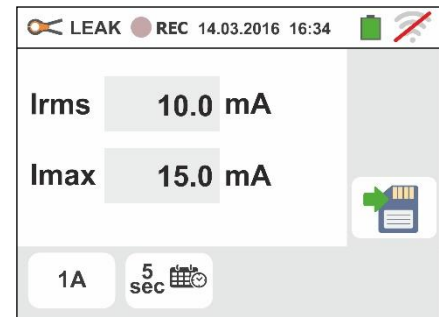

7. Press the **GO/STOP** key to start recording. The instrument enters stand-by mode (waiting for the next minute or the set date/time) and the “” symbol is displayed as shown in the screen to the side.

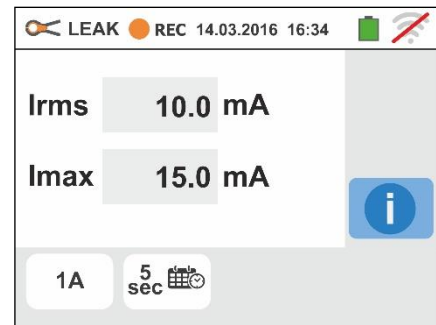

8. With recording running, the “” symbol is displayed as shown in the screen to the side.

Touch the “” icon to read in real time the information about on-going recording. The following screen appears on the display

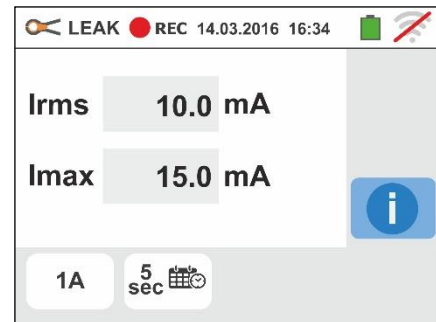

9. The screen contains:

- The number of recording
- The date/time of recording start (if automatic)
- The date/time of recording stop (if automatic)
- The aggregation time set
- The number of aggregation intervals recorded
- The residual memory capacity expressed in DD-HH-MM



- 10 Press **GO/STOP** key to stop recording; the instrument automatically saves the result in its memory (see § 7.1.3). The message to the side is shown.

Confirm by touching the “” icon or touch the “” icon to go back to the previous screen

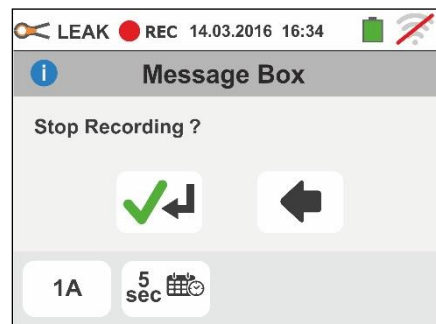

6.2. AUX: MEASURE AND RECORDING OF AMBIENT PARAMETERS

By means of external transducers, this function allows measuring and recording the following environmental parameters:

- °C air temperature in °C by means of thermometric transducer
- °F air temperature in °F by means of thermometric transducer
- Lux(20)** illuminance by means of luxmetric transducer with a 20Lux capacity
- Lux(2k)** illuminance by means of luxmetric transducer with a 2kLux capacity
- Lux(20k)** illuminance by means of luxmetric transducer with a 20kLux capacity
- RH%** air relative humidity by means of humidity transducer
- mV** input DC voltage (without applying any transduction constant)

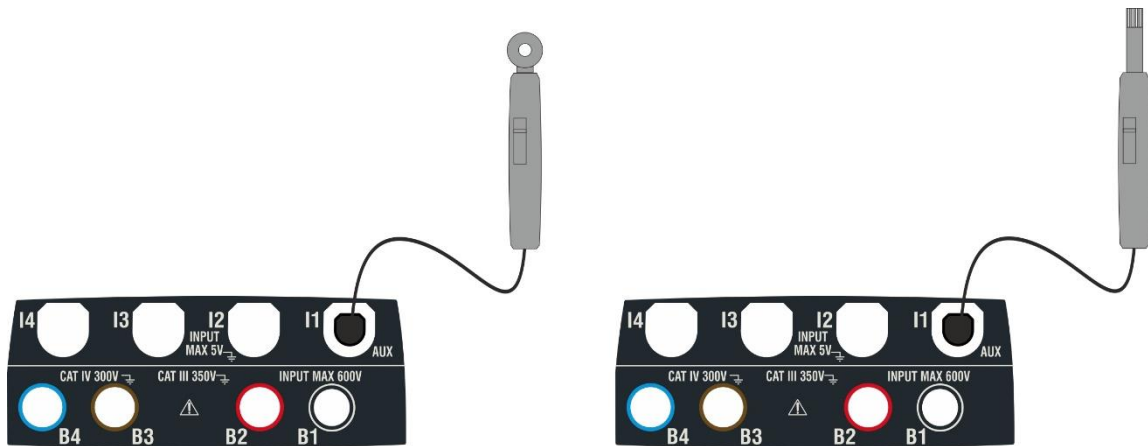

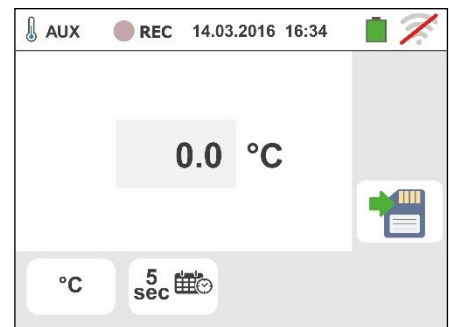

Fig. 8: Measurement of environmental parameters through external probes

1

Touch the icon . The screen to the side appears on the display.

Touch the  icon to set the type of measurement. The following screen appears on the display:



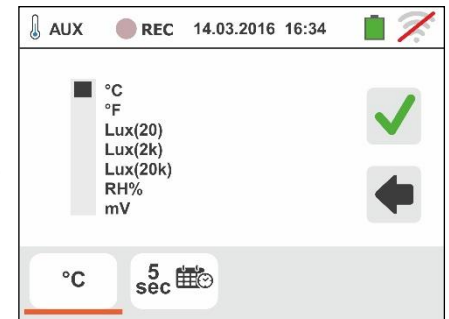

2 Move the slide bar reference to select the type of measurement among the options: °C (temperature in Celsius degrees), °F (temperature in Fahrenheit degrees), **Lux(20)** (illuminance with 20Lux capacity), **Lux(2k)** (illuminance with 2kLux capacity), **Lux(20k)** (illuminance with 20kLux capacity), **%RH** (relative humidity), **mV** (measurement of DC voltage up to 1V)

Touch the  icon to set the parameters of recording. The followed screen is shown





3 Move the left slide bar cursor in order to select the aggregation time (see § 12.5) among the options: **2s, 5s, 10s, 30s, 1min, 2min, 5min, 10min, 15min, 30min**

Move the central slide bar cursor (“GO” symbol) to the positions:

-  → **Manual** start of recording by pressing the **GO/STOP** key (at the next minute after the pressure of key)
-  → **Automatic** start of recording at the date/time set by the user (after a preliminary pressure of **GO/STOP** key in order to set the instrument in stand-by mode). **Touch the corresponding field to set the date/time** in the “MM:DD:YY HH:MM” format and confirm

Move the right slide bar cursor (“STOP” symbol) in the positions:

-  → **Manual** stop of recording by pressing the **GO/STOP** key
-  → **Automatic** stop of recording at the date/time set by the user. **Touch the corresponding field to set the date/time** in the “MM:DD:YY HH:MM” format and confirm

4 Insert in the auxiliary **I1** input the transducer necessary for the desired measurement as shown in Fig. 8

5 The measured value appears on the display in real time as shown in the screen to the side.

Press the **SAVE** button or touch the  icon to save the measurement (see § 7.1).

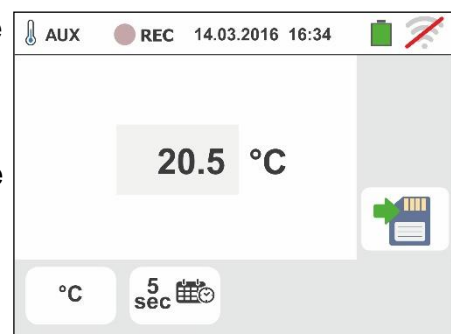
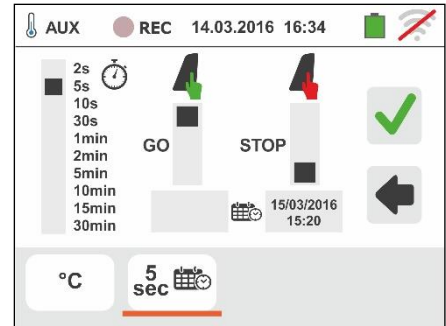

6. Press the **GO/STOP** key to start recording. The instrument enters stand-by mode (waiting for the next minute or the set date/time) and the “” symbol is displayed as shown in the screen to the side.

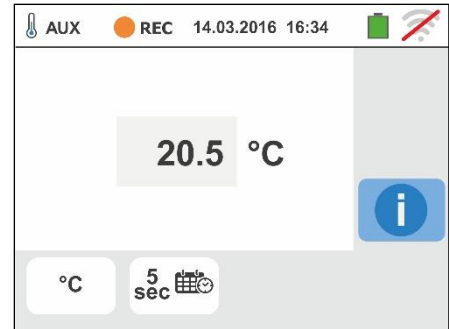

7. With recording running, the “” symbol is displayed as shown in the screen to the side.

Touch the “” icon to read in real time the information about on-going recording. The following screen appears on the display

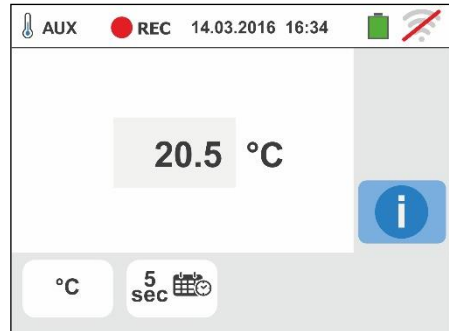

8. The screen contains:

- The number of recording
- The date/time of recording start (if automatic)
- The date/time of recording stop (if automatic)
- The aggregation time set
- The number of aggregation intervals recorded
- The residual memory capacity expressed in DD-HH-MM

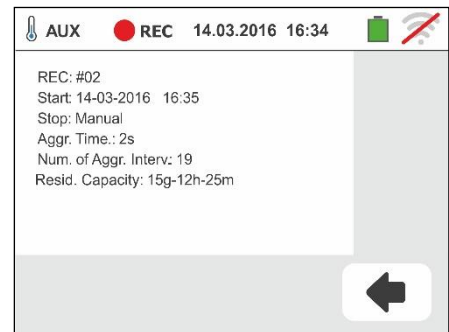

9. Press **GO/STOP** key to stop recording; the instrument automatically saves the result in its memory (see § 7.1.3). The message to the side is shown.

Confirm by touching the “” icon or touch the “” icon to go back to the previous screen

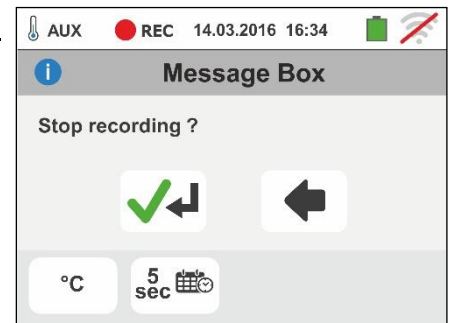

6.3. PQA: MEASUREMENT AND RECORDING OF MAIN PARAMETERS

In this section the instrument allows the below operations:

- Real-time display of numeric values of any electrical parameters of a single-phase and three-phase 3-wire or 4-wire system, harmonic analysis of voltages and currents up to 49th order, power/energies and power peaks absorbed/generated
- Real-time display of any input signal waveform, histogram graphics of harmonics analysis, vector diagrams of mutual angles between voltages and currents and voltage unbalances
- Recording (by pressing the **GO/STOP** key) of TRMS values of voltages, voltage anomalies (sags, swells) with 20ms resolution, currents, corresponding harmonics, active, reactive and apparent powers, power factors and cosphi, active, reactive and apparent energies. **It will be possible to analyze the recorded data ONLY by transferring them onto a PC**

Saving (by pressing the **SAVE** key) of an “Instant” sampling of instantaneous values of any parameters present at instrument input in the instrument’s memory.



CAUTION

- The instrument can be used for measurements on installations with overvoltage category CAT IV 300V to earth and max 600V between inputs. Do not connect the instrument on installations with voltage exceeding the limits indicated in this manual. Exceeding these limits could cause electrical shock to the user and damage to the instrument.
- Always connect the measuring cables to the instrument and to the alligator clips with the accessories disconnected from the system
- We recommend holding the alligator clip respecting the safety area created by the hand protection (see § 4.2).

6.3.1. Connections types

The following types of electric systems can be selected in the instrument:

- Three-phase system **3φ-4WIRES** (three-phase + neutral + PE)
- Three-phase system **3φ-3WIRES** (three-phase without neutral + PE)
- Three-phase system **3φ-ARON** (three-phase + PE)
- Single-phase system **1φ-2WIRES** (phase + neutral)
- Three-phase system 4-wires **3φ-High Leg** – for USA country
- Two-phase system 3-wires **3φ-Y Open** – for USA country
- Three-phase system 3-wires **3φ-Δ Open** – for USA country
- Two-phase system 3-wires **3φ-2EI. ½** – for USA country
- Two-phase system 3-wires **1φ- CentrePoint** – for USA country

Below, the connection schemes corresponding to the above-described situations are reported:

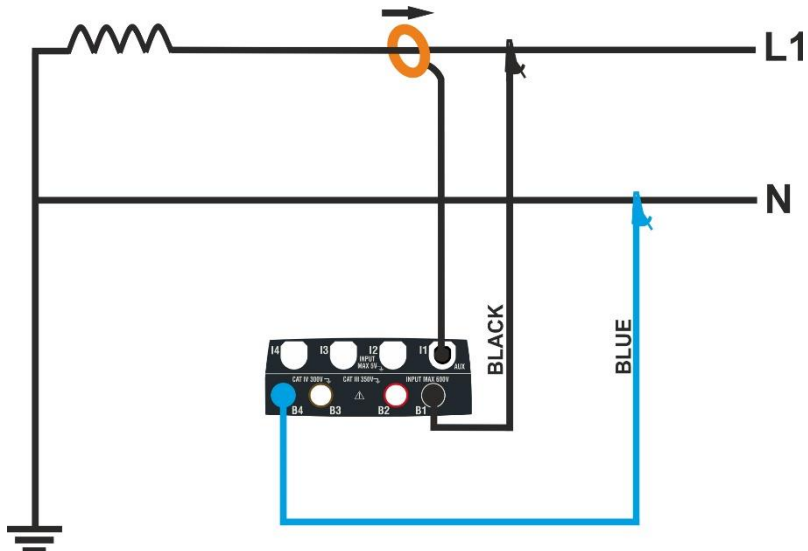

Fig. 9: Connection for measurement on single-phase **1φ-2WIRES**

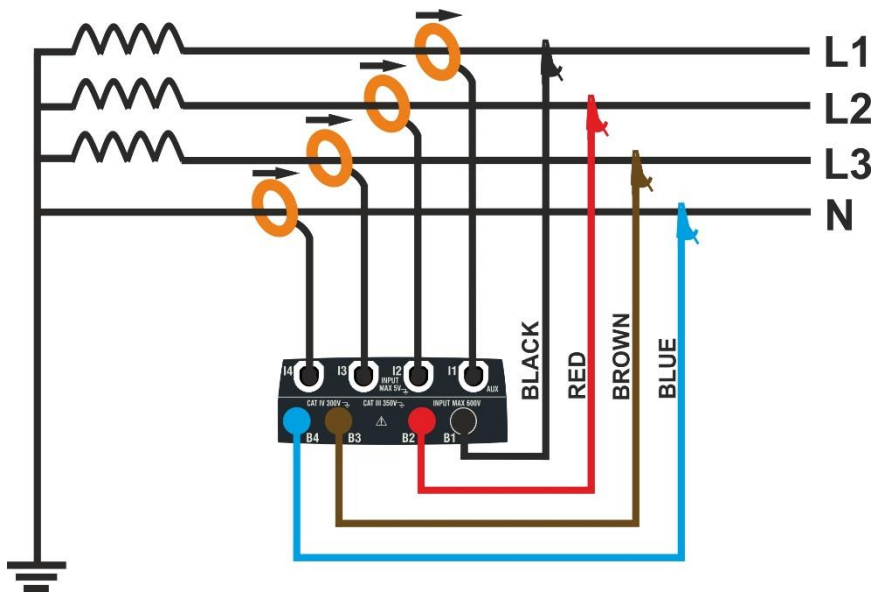

Fig. 10: Connection for measurement on Three-phase system **3φ-4WIRES**

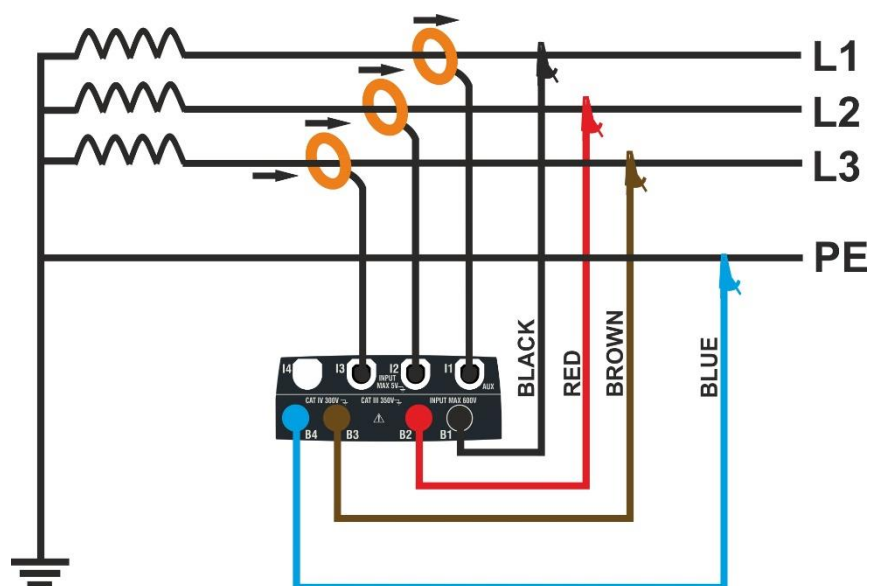

Fig. 11: Connection for measurement on Three-phase system **3φ-3WIRES**

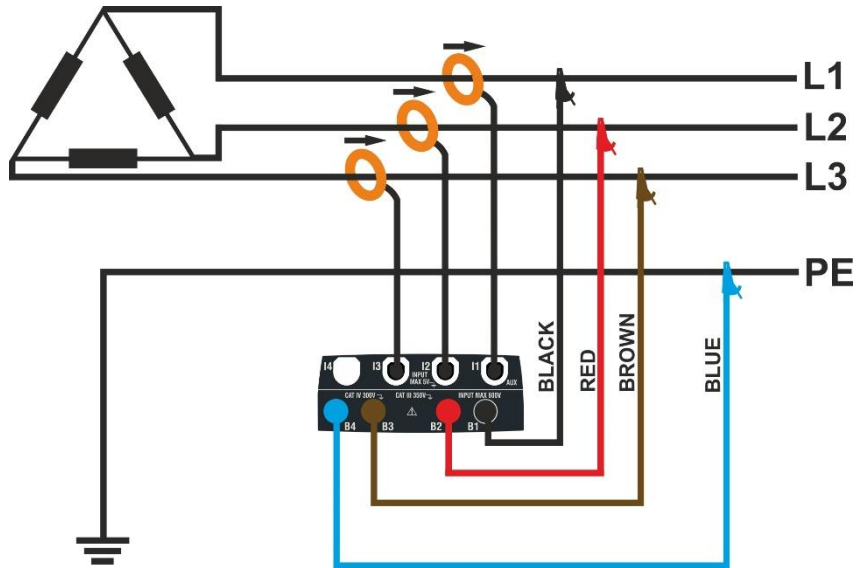

Fig. 12: Connection for measurement on Three-phase system 3ϕ -ARON

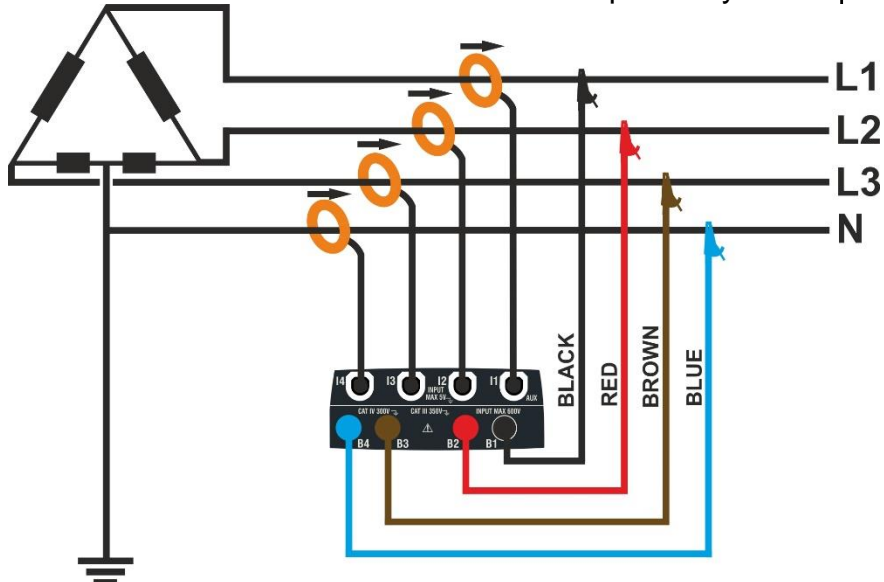

Fig. 13: Connection for measurement on Three-phase system 4-wires 3ϕ -High Leg

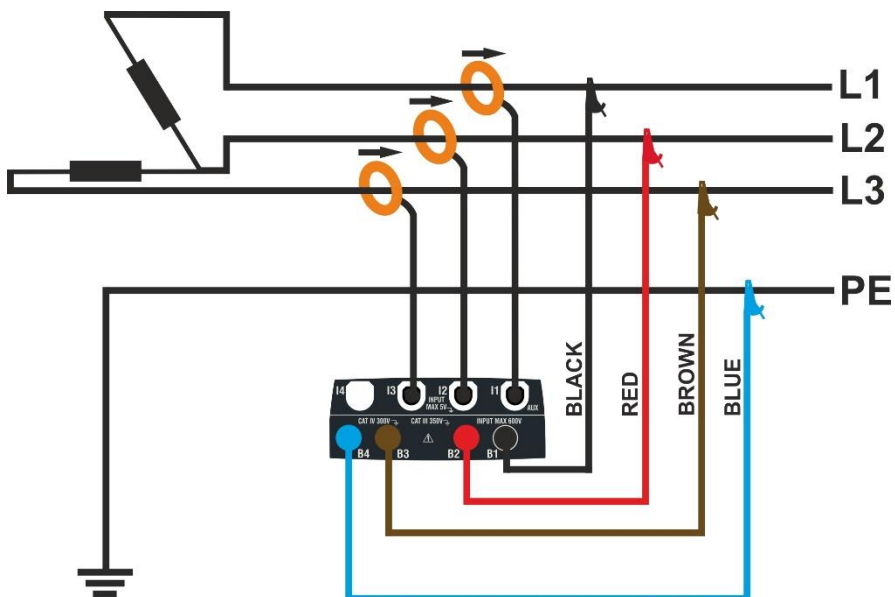

Fig. 14: Connection for measurement on Three-phase system 3-wires 3ϕ - Δ Open

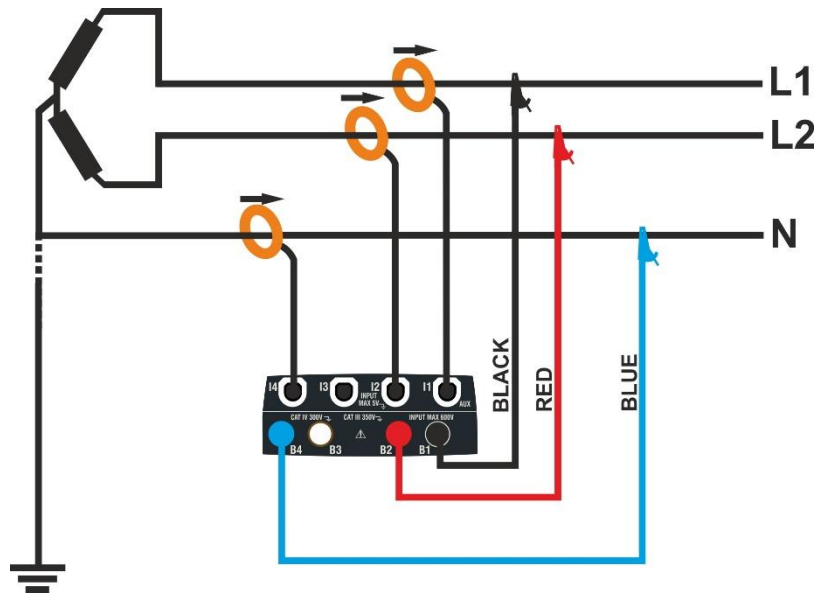

Fig. 15: Connection for measurement on Two-phase system 3-wires **3φ-Y Open**

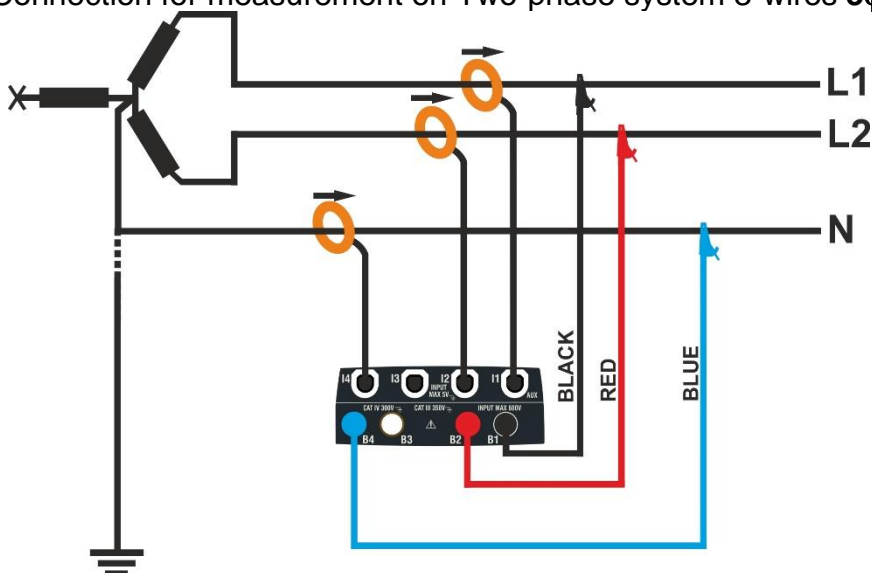

Fig. 16: Connection for measurement on Two-phase system 3-wires **3φ-2EI. 1/2**

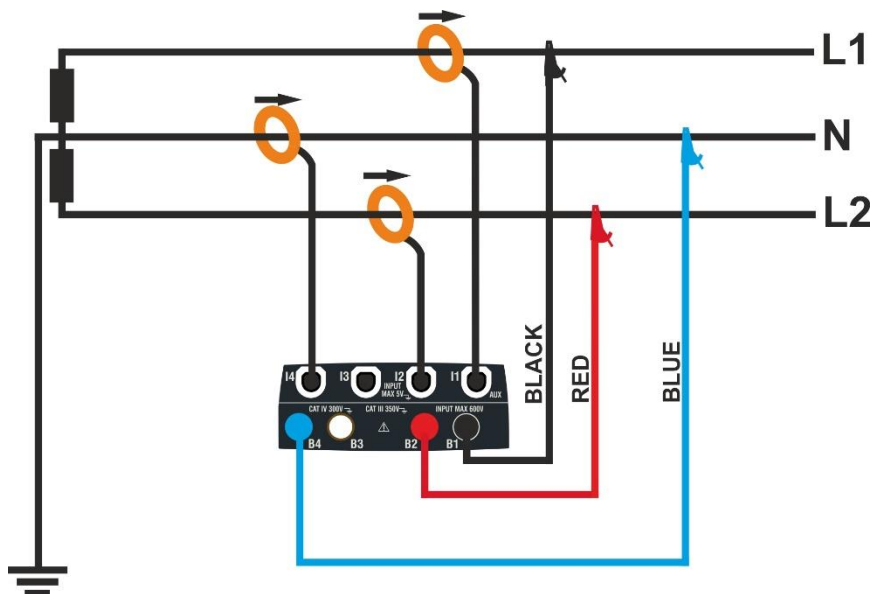



Fig. 17: Connection for measurement on Two-phase system 3-wires **1φ-CentrePoint**

6.3.2. General settings

1.

Touch the  icon. The display shows the screen on the right.



Touch the  icon in order to set:

- The type of connection
- The nominal reference voltage and the percentage of positive and negative thresholds for the detection of voltage anomalies
- The ratio of possible VT transformers presents on the installations
- The type and the full scale of transducers clamps used for phase and neutral currents
- The aggregation time and the type of recording start/stop
- The type of possible pre-set configuration

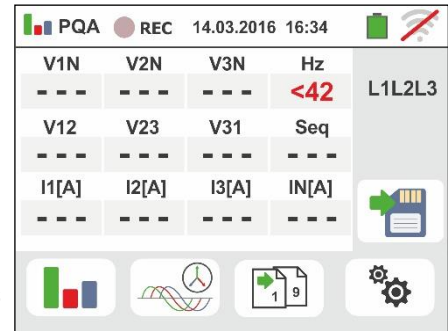

The display shows the following screen



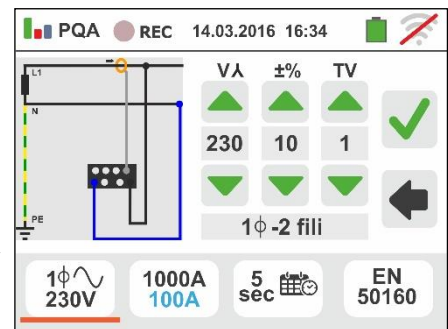

2. Touch the interactive scheme to select the type of connection among the possible situations of § 6.3.1. Note the description in the bottom part of the display.

Touch the  or  icon keys in order to set the nominal value **V** of the phase-neutral voltage (single-phase or three-phase 4-wire systems) for the detection of voltage anomalies (sags, swells) within the range: **12V ÷ 600V**. Press and hold the keys for a quick selection of value.





Touch the  or  icon keys in order to set the **±%** percentage of positive (sags detection) and negative (swell detection) thresholds with respect to the nominal voltage within the range: **3% ÷ 30%**. Press and hold the keys for a quick selection of values



Touch the  or  icon keys in order to set the ratio of possible VT transformers presents on the installations within the range: **30 ÷ 3000**. Press and hold the keys for a quick selection of values. **With no VT on the installation (direct connection) the value of this parameter must be always 1**

Touch the  icon in order to set the type and the full scale of the used transducer clamps. The display shows the following screen

3. Move the slide bar cursor in order to select the type of clamp for phase current and neutral current measurement (marked in blue color), considering that the clamps can be of different types, between the options:

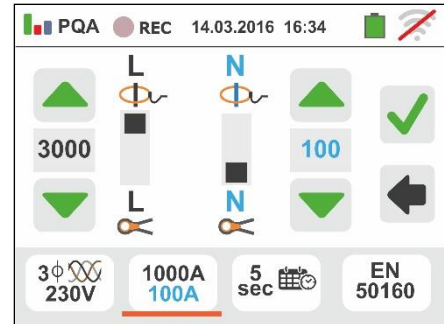
-  → Flexible transducer clamp type (FLEX)
-  → Standard rigid clamp (STD)





Touch the  or  icon keys in order to set the full scale value of the clamps selected for phase and neutral current (marked in blue color) between the options: **300A** or **3000A** (FLEX clamp), range: **1A ÷ 3000A** (STD clamp). Press and hold the keys for a quick selection of values

Touch the  icon to set the parameters of recording. The following screen is shown



4. Move the left slide bar cursor in order to select the aggregation time (see § 12.5) among the options: **2s, 5s, 10s, 30s, 1min, 2min, 5min, 10min, 15min, 30min**

Move the central slide bar cursor (“GO” symbol) to the positions:

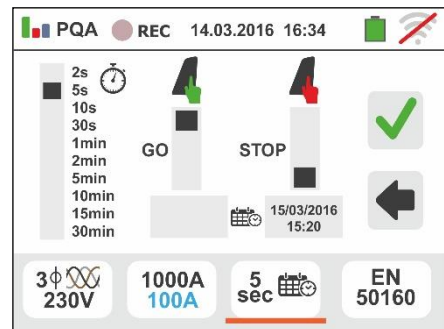
-  → **Manual** start of recording by pressing the **GO/STOP** key (at the next minute after the pressure of key)
-  → **Automatic** start of recording at the date/time set by the user (after a preliminary pressure of **GO/STOP** key in order to set the instrument in stand-by mode). **Touch the corresponding field to set the date/time** in the “MM:DD:YY HH:MM” format and confirm





Move the right slide bar cursor (“STOP” symbol) in the positions:

-  → **Manual** stop of recording by pressing the **GO/STOP** key
-  → **Automatic** stop of recording at the date/time set by the user. **Touch the corresponding field to set the date/time** in the “MM:DD:YY HH:MM” format and confirm

5. Touch the  icon in order to select the pre-set configuration (see § 12.6) among those made available by the instrument. A screen like the one to the side is shown. The following options can be selectable:



- **EN50160** → Automatic setting of internal parameters through the instrument in compliance with voltage quality network requirements of guideline EN50160
- **kWh** → Automatic setting of internal parameters through the instrument for the analysis of power/energy problems
- **HARM** → Automatic setting of internal parameters by the instrument for voltage/current harmonic analysis
- **DEFAULT** → Automatic setting of all recording parameters

Confirm each setting by touching the  icon or touch the  icon to go back to main screen

6. Insert the connectors of the test cables into the **B1, B2, B3, B4** input terminals for voltage measurements depending on the selected connection type. Insert the remaining free end of the cables into the corresponding crocodiles or tips. Connect crocodiles or test leads to phase L1, L2, L3 and N according to the images in § 6.3.1. Connect the clamps to **I1, I2, I3** and **I4** inputs and to the phase conductors according to the images in § 6.3.1. The arrow on the clamp must point in the direction in which the current normally flows from the generator to the load



6.3.3. Display of measurements

7. The screen like the one to the side shows the numerical real-time values of electric parameters, referred to a three-phase 4-wire system. For the meaning of the parameters, please refer to § 12.4

V1N	V2N	V3N	Hz	
230.0	230.3	230.1	50.0	L1L2L3
V12	V23	V31	Seq	
401.0	400.0	399.0	123	
I1[A]	I2[A]	I3[A]	IN[A]	
235.7	242.6	240.5	52.5	

Touch the  icon to show the pages (the number of which depends on the type of selected connections) of the TRMS values relevant to total powers, total power factors and values referred to the single phases as shown in the following screen

Press the **SAVE** button or touch the  icon to save the measurement on the display as instantaneous snapshot (see § 7.1)

8. The “” and “” symbols show the Inductive or Capacitive type of the load, respectively.

Press the **SAVE** button or touch the  icon to save the measurement on the display as instantaneous snapshot (see § 7.1)

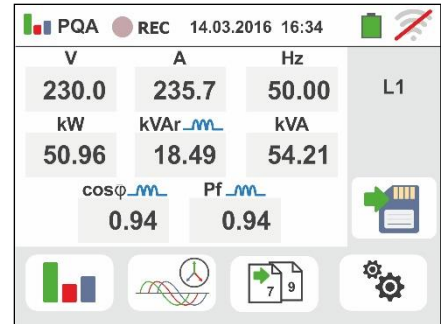

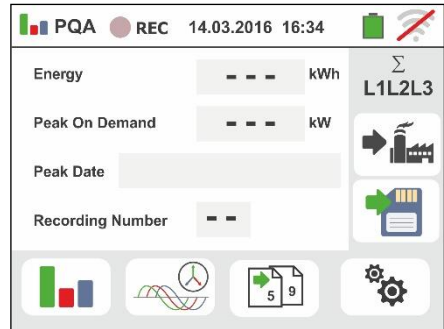

9. Touch the  icon to access the pages of absorbed/generated power/energies. The screen like the one to the side in the condition of **recording not activated** is shown



10. Touch the  icon to show the pages of input signal waveforms and vector diagrams of voltages/currents. The screen like the one to the side shows the real-time values of phase angles between voltage and current relevant to a three-phase system. The parameters are indicated with small squares in different colors and the angular values are shown on the right side. The positive rotation reference associated with each vector diagram is **clockwise**.

In the bottom part of the display there are the “Rev” and “Zero” indications associated with the unbalance of input voltages (see §)

Press the **SAVE** button or touch the  icon to save the measurement on the display as instantaneous snapshot (see § 7.1)

Touch the  icon to show the signal waveforms. The following screen (referred to phase L2) is shown on the display

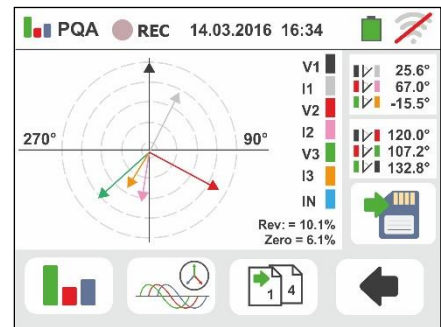

- 11 The screen like the one to the side shows the real-time waveforms of voltage and current relevant to a three-phase system. The parameters are indicated with small squares in different colors and the RMS values are shown on the right side.

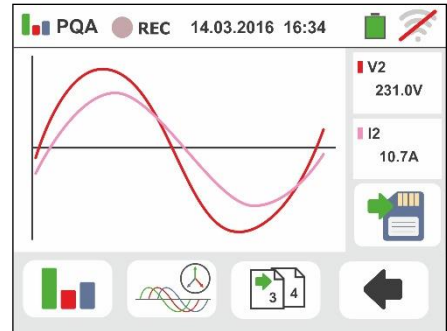

Press the **SAVE** button or touch the icon to save the measurement on the display as instantaneous snapshot (see § 7.1).

Touch the icon to go back to the main screen of RMS values

- 12 Touch the icon to show the parameters of harmonic analysis. The screen like the one to the side shows a three-phase situation. The histogram graph of percentage amplitude relevant to fundamental and voltage/current harmonics from **DC**, from the **1° up to the 49° order**, is shown on the display. A blue frame automatically shows the harmonic with the highest amplitude (except for the fundamental). The numeric value of harmonic amplitude (identified by “hxx”) and the THD% value (see §) are shown on the right side. Touch the “◀” or “▶” arrow icons to increase or decrease the harmonic order. Press the **SAVE** button or touch the icon to save the measurement on the display as instantaneous snapshot (see § 7.1). Touch the icon to go back to the main screen of RMS values

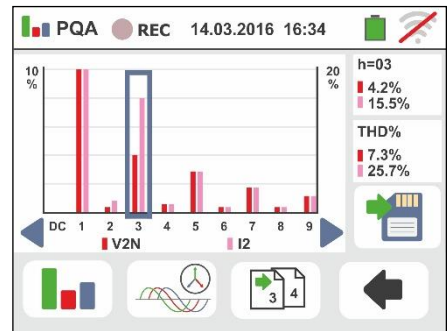

6.3.4. Start recording

- 13 Press the **GO/STOP** key to start recording. The instrument enters stand-by mode (waiting for the next minute or the set date/time) and the “” symbol is displayed as shown in the screen to the side

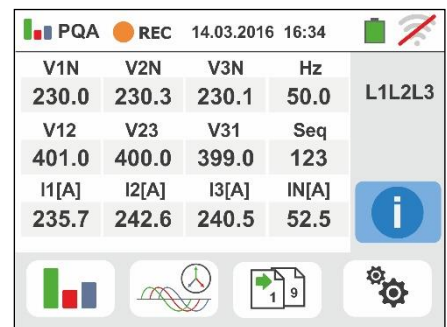

- 14 With recording running, the “” symbol is displayed as shown in the screen to the side.

Touch the “” icon to read in real time the information about the on-going recording. The following screen appears on the display

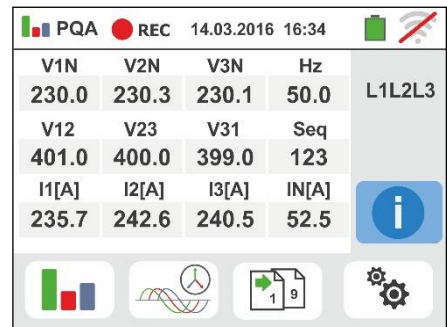

15 The screen shows:

- The number of the recording
- The date/time of recording start (if automatic)
- The date/time of recording stop (if automatic)
- The aggregation time set
- The number of aggregation intervals recorded
- The residual memory capacity in DD-HH-MM
- The number of detected voltage anomalies

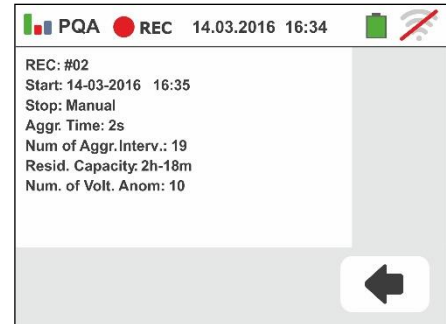

16 Press the **GO/STOP** key to stop recording; the instrument automatically saves the result in its memory (see § 7.1.3). The message to the side is shown.

Confirm by touching the “” icon or touch the “” icon to go back to the previous screen

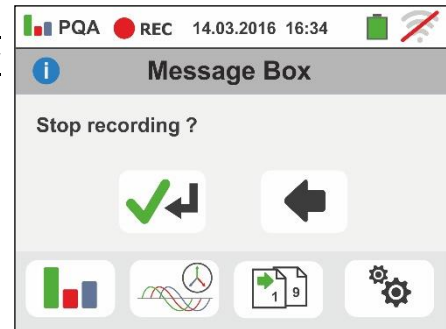

17 After recording has stopped, touch the  icon in order to select the display of the **absorbed** power/energy measured by the instrument as shown in the screen to the side. The following items are included:

- The  icon, which indicates the consumption of power/energy **absorbed** by the load
- The value of absorbed energy while recording
- The peak of power absorbed while recording
- The date/time of the above-mentioned peak of power
- The number of recordings to which the above results are referred

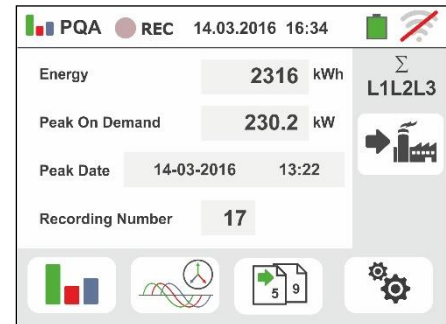

18 Touch the  icon in order to select the display of **generated** power/energy measured by the instrument as shown in the screen to the side. The following items are included:

- The  icon, which indicates the consumption of power/energy **generated** by the load
- The value of generated energy while recording
- The peak of power generated while recording
- The date/time of the above-mentioned peak of power
- The number of recordings to which the above results are referred

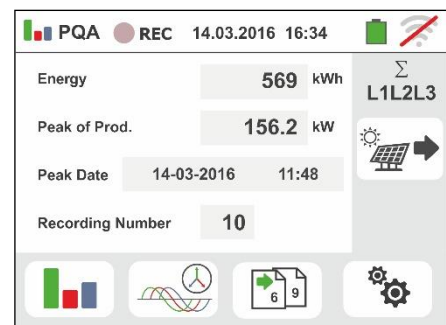

CAUTION

The visualization of powers/energies absorbed/generated are only real time readings and **cannot be saved** inside the instrument's memory.

6.4. LIST OF MESSAGE AT DISPLAY

MESSAGE	DESCRIPTION
Range: 1..15	Values out of range. Check the setup of instrument
Range: 5..999	
Range: 0.01..100	
Range: 1..500	
Range: 0.04..10s	
Range: 0..199	
Range: 1..200	
Range: 1..999	
Range: 1..3000	
Internal synchronization	Synchronization error. Switch off and on the instrument
Checksum error	Communication error. Check the PC connection
Error writing parameter	Contact service department
Serial command error	Communication error. Check the PC connection
Battery low	Replace or recharge batteries
Internal error	Contact service department
Resistance: High temperature	Switch off and let cool the instrument
MOS: High temperature	Switch off and let cool the instrument
Resistance: Low temperature	Contact service department
Test time too long	Switch off and on the instrument and repeat the test
IGBT damaged	Contact service department
Memory full	Memory is full. Download the saved measurements
Two phase system	Function not available in Phase-Phase-PE systems
Not available during a Recording	Function not available during a recording
Error: FRAM writing	Contact service department

7. OPERATIONS WITH THE MEMORY

7.1. SAVING MEASUREMENTS





The structure of the memory is divided into two independent areas for the SNAPSHOTS section (PQA, LEAKAGE, AUX snapshots – max 999 locations) and for RECORDINGS (PQA, AUX, LEAKAGE recordings). The SNAPSHOTS section memory is of "tree" type with the possibility to expand/hide the nodes, allows the division up to 3 markers nested so as to finalize the precise locations of the measuring points with the insertion of test results. Each marker has associated up to **20 fixed names (non-editable or deletable)** + max 20 names that can be freely defined by the user by means of management software (see the online help of the program). For each marker, it is also possible to associate a number between 1 and 250.

7.1.1. Saving snapshots



1. At the end of each measurement, press the **SAVE** key

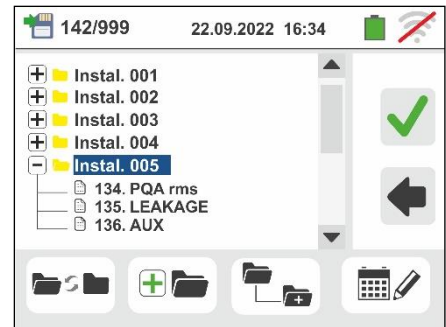

or touch the  icon to save its result. The screen to the side appears on the display.

The meaning of the icons is the following:

-  → It expands/hides the selected node
-  → It allows the choice of a 1st level node
-  → It inserts a nested sub-node (max 3 levels)
-  → It adds a user comment on the performed measurement



2. Press the  or  key to insert a main marker or a sub-marker. The screen to the side is shown by the instrument.

Touch one of the names on the list this to select the desired marker. Touch the arrow keys  or  to enter a number associated with the marker, if needed.

Confirm the choices by returning to the main screen.

Touch the  key. The following screen appears on the display:

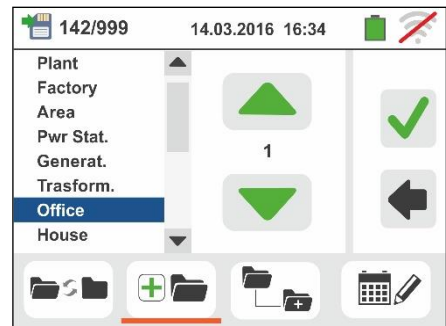

3. Use the virtual keyboard to enter any comment on the measurement. This comment will be visible both after downloading the saved data to a PC with management software (see § 8) and recalling the result at display (see § 7.1.2)

Confirm the choices by returning to the main screen.

Further confirm to permanently save the measurement in the internal memory. A confirmation message is provided by the instrument.





7.1.2. Recalling and deleting snapshots

1. Touch the  icon in the general menu. The screen to the side appears on the display.

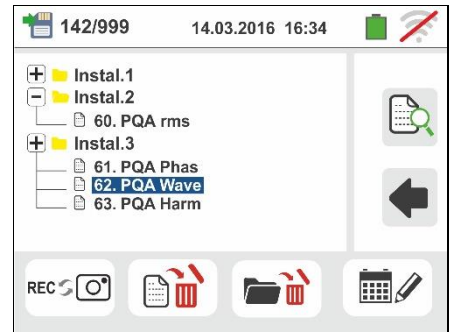
Touch the  icon to recall the measurement result. The following screen appears on the display:



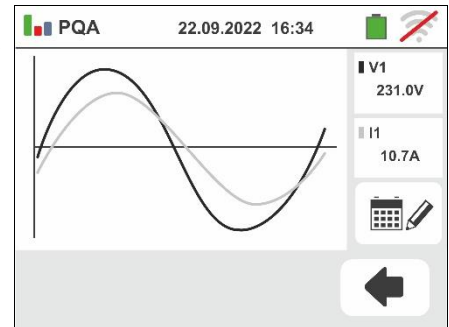

2. Touch the  icon to recall and possibly change the comment entered when saving via the internal virtual keyboard.

Touch the  icon to go back to the previous screen.





3. Touch the  icon to recall the results of saved recordings (see § 7.1.3)

Touch the  icon to delete **the last saved result in the instrument memory**. The following screen appears on the display:

Touch the  icon to confirm the operation or the  icon to return to the previous screen.



4. Touch the  icon to delete **all the results stored in the memory of the instrument**. The following screen appears on the display:

Touch the  icon to confirm the operation or the  icon to return to the previous screen.



7.1.3. Recall and delete saved recordings

The recordings are **automatically** saved inside memory at the pressure of **GO/STOP** key or at the end of set stop date/time. The **SAVE** key allows saving the instantaneous snapshots show at display during the recording..

Touch the  icon to recall the list of saved recordings (LEAK, AUX and PQA functions) performed by the instrument. The following screen is shown

1. Select the desired recording indicated as “REC_ xxx” and

touch the  to recall at display. The followed screen is shown

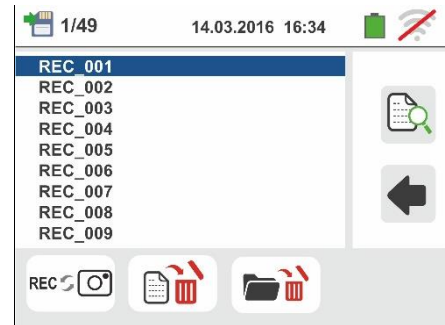

2. In the screen is shown:

- The recording number
- The date/time of start recording (if automatic)
- The date/time of stop recording (if automatic)
- The aggregation time set
- The number of aggregation intervals recorded
- The residual memory capacity expressed in DD-HH-MM
- The number of detected voltage anomalies (sags, swells).

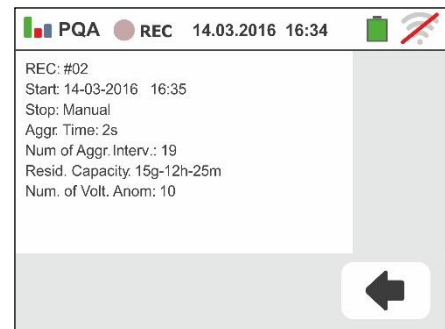

The name of recording is not modify on the instrument.

Touch the  icon to return to the previous screen

Touch the  icon to delete **the last saved recording**

Touch the  icon to delete **all** the saved recordings

7.1.4. Anomalous situations

1. In case there is no measure saved and the instrument memory is accessed, a screen similar to the one reported here to the side is displayed.



2. In case tries to define a new sub-node over the 3rd level the instrument provides the warning screen shown to the side and blocks the operation

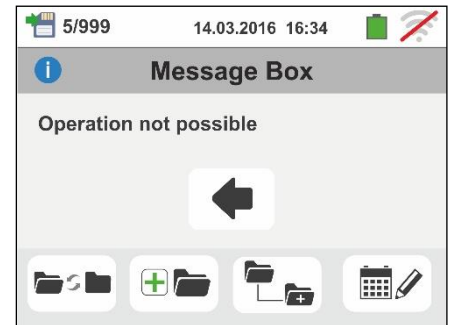

3. In case tries to create a sub-node by using a just used name, the instrument provides the warning screen shown to the side and is necessary to define a new name

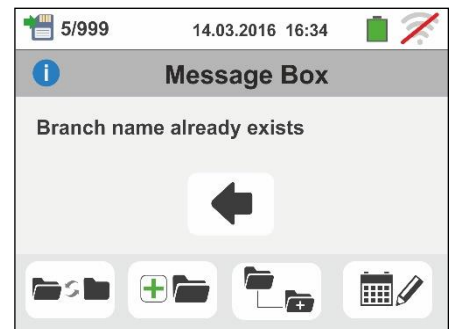

4. In case tries to define a numebr of nodes of 1st, 2nd and 3rd level higher than 250 (for each level), the instrument provides the warning screen shown to the side

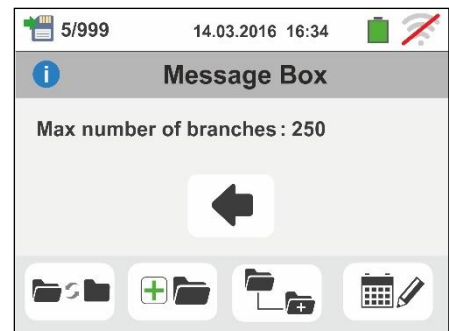

5. In case tries to include a comment of length higher than 30 chars, the instrument provides the warning screen shown to the side

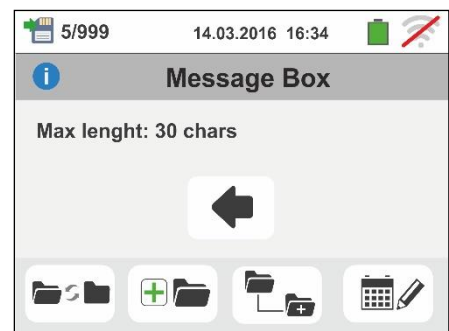



8. CONNECTING THE INSTRUMENT TO A PC

The connection between a PC and the instrument can be done via a serial port (see Fig. 3) by means of an optical cable/USB C2006 or by means a WiFi connection. Before making the connection in USB mode, it is **necessary** to install on the PC the management software TopView downloadable from the www.ht-instruments.com/download website. To transfer stored data to PC keep to the following procedure:

Connection to PC via optical/USB cable

1. Switch on the instrument by pressing the **ON/OFF** key.
2. Connect the instrument to the PC via the optical cable/USB.

3. Touch the  icon in the general menu. The screen to the side is shown by the instrument. Disable the WiFi connection touch the icon in the top right side of the display. The symbol “” appear at display.

In these conditions, the instrument is able to communicate with the PC via USB port



4. Use the management software to download the instrument memory contents to a PC. Please refer to the online help of the program itself for any detail regarding the operation.
5. Touch the  icon to go back to the general menu of the instrument.

Connecting to a PC through WiFi

1. Put the instrument in data transfer mode to a PC (see § 8 - point 3). Enable the WiFi connection touch the icon in the top right side of the display. The symbol “” appear at display.
In these conditions, the instrument is able to communicate with the PC via WiFi connection



2. Enable the WiFi connection on the target PC (ex: by using a WiFi key installed and connected to a USB port) and connect to the WiFi network enabled by the instrument (name of network “VEGA74_XXXXXX” where XXXXXX is the serial number of the instrument)
3. Launch the management software, select the "WiFi" port and "Detect instrument" within the section "PC-Instrument connection"
4. Use the management software to download the instrument memory contents to a PC. Please refer to the online help of the program itself for any detail regarding the operation.

9. MAINTENANCE

9.1. GENERAL INFORMATION

- While using and storing the instrument, carefully observe the recommendations listed in this manual in order to prevent possible damage or danger during use.
- Do not use the instrument in environments with high humidity levels or high temperatures. Do not expose to direct sunlight.
- Always switch off the instrument after use. Should the instrument remain unused for a long time, remove the batteries to avoid liquid leaks that could damage the instruments internal circuits.

9.2. RECHARGING AND REPLACEMENT OF THE BATTERIES

When the LCD display shows the low battery symbol "", recharge the rechargeable batteries or replace the alkaline batteries.



CAUTION

- Only expert and trained technicians should perform this operation. Before carrying out this operation, make sure you have disconnected all cables from the input terminals
- **Do not connect the adapter A0061 if the instrument is powered by alkaline (not rechargeable) batteries**

1. Switch off the instrument by pressing the **ON/OFF** key.
2. Remove the cables from the input leads
3. Loosen the battery compartment cover fastening screw and remove the cover.
4. Remove all the batteries (if not rechargeable) from the battery compartment and replace them with new batteries of the right type only (§ 10.4), making sure to respect the indicated polarities. To recharge the batteries, use the external battery charger A0061 supplied with the instrument. The symbol "" is shown during the recharging process. The batteries can be considered as completely recharged after approx. 12 hours. **The external adapter A0061 does not recharge alkaline batteries.**
5. Restore the battery compartment cover into place and fasten it by mean of the relevant screw.
6. Do not scatter old batteries into the environment. Use the relevant containers for disposal.

9.3. CLEANING THE INSTRUMENT

Use a soft and dry cloth to clean the instrument. Never use wet cloths, solvents, water, etc.

9.4. END OF LIFE



CAUTION: the symbol on the instrument indicates that the appliance and its accessories must be collected separately and correctly disposed of.

10. TECHNICAL SPECIFICATIONS

Accuracy is calculated as: $\pm[\% \text{reading} + (\text{no. of digits}) * \text{resolution}]$ at 23°C, <80%RH.

10.1. TECHNICAL CHARACTERISTICS AUX AND LEAKAGE SECTIONS

Leakage current (input I1 – STD clamp)

FS AC Clamp [A]	Resolution [A]	Accuracy
1	0.1mA	±(1%rdg + 20dgt)
1 < FS < 10	0.01A	
10 ≤ FS < 100	0.1A	
100 ≤ FS ≤ 1000	1A	

Environmental parameters

Measurement	Range	Resolution	Accuracy
°C	-20.0 ÷ 60.0°C	0.1°C	±(2%rdg + 2digits)
°F	-4.0 ÷ 140.0°F	0.1°F	
RH%	0.0% ÷ 100.0%RH	0.1%RH	
DC voltage	0.1mV ÷ 1.0V	0.1mV	
Lux	0.001 ÷ 20.00lux (*)	0.001 ÷ 0.02Lux	
	0.1 ÷ 2.0klux (*)	0.1 ÷ 2Lux	
	1 ÷ 20.0klux (*)	1 ÷ 20Lux	

(*) Accuracy of the luxmetric probe according to Class AA

10.2. TECHNICAL CHARACTERISTICS PQA SECTION

DC/AC TRMS Voltage (Phase-Neutral)

Range [V]	Resolution [V]	Accuracy
15.0 ÷ 380.0	0.1V	±(1.0%rdg + 1dgt)

Crest factor: ≤ 1,5 ; Frequency: 42 ÷ 69.0 Hz

Connection to external TV: TV ratio selectable in the range 30 ÷ 3000

DC/AC TRMS Voltage (Phase-Phase)

Range [V]	Resolution [V]	Accuracy
15.0 ÷ 660.0	0.1V	±(1.0%rdg + 1dgt)

Crest factor: ≤ 1,5 ; Frequency: 42 ÷ 69.0 Hz

Connection to external TV: TV ratio selectable in the range 30 ÷ 3000

Frequency

Range [Hz]	Resolution [Hz]	Accuracy
DC, 42 ÷ 69.0	0.01	±(2.0%rdg + 2dgt)

Allowed voltage: 15.0 ÷ 660V ; Allowed current: 5%FS clamp ÷ FS clamp

DC/AC TRMS Current (STD clamp)

FS clamp	Range [A]	Resolution [A]	Accuracy
≤ 10A	5% FS ÷ 9.99	0.01	±(1.0%rdg + 3 dgt)
10A ≤ FS ≤ 300	5% FS ÷ 299.9	0.1	
300A ≤ FS ≤ 3000	5% FS ÷ 2999	1	

Range: 5 ÷ 999.9 mV, values under 5mV are zeroed, Crest factor: ≤ 2.4; Frequency: 42 ÷ 69.0 Hz

AC TRMS Current (FLEX Clamp - 300A AC range)

Range [mV]	Frequency [Hz]	Resolution	Accuracy	Overload protection
0.085 ÷ 85.0	42 ÷ 65.0	8.5μV	±(0.5%rdg+0.17%FS)	10V

Crest factor ≤3 . Allowed current <1A are zeroed

AC TRMS Current (FLEX Clamp - 3000A AC range)

Range [mV]	Frequency [Hz]	Resolution	Accuracy	Overload protection
0.425 ÷ 255.0	42 ÷ 65.0	85μV	±(0.5%rdg+0.17%FS)	10V

Crest factor ≤3 . Allowed current <10A are zeroed

DC Power

FS clamp	Range [kW]	Resolution [kW]	Accuracy
≤10A	0.000 ÷ 9.999	0.001	±(2.0%rdg + 7dgt)
	10.00 ÷ 99.99	0.01	
10A < FS ≤ 200A	0.00 ÷ 99.99	0.01	
	100.0 ÷ 999.9	0.1	
200A < FS ≤ 1000A	0.0 ÷ 999.9	0.1	
	1000 ÷ 9999	1	

Active power (@ 230V, I> 5% FS, cosφ>=0.5, f=50.0Hz)

FS clamp	Range [kW]	Resolution [kW]	Accuracy
≤ 10A	0.000 ÷ 9.999	0.001	±(2.0%rdg + 7dgt)
	10.00 ÷ 99.99	0.01	
10A < FS ≤ 200	0.00 ÷ 99.99	0.01	
	100.0 ÷ 999.9	0.1	
200A < FS ≤ 1000	0.0 ÷ 999.9	0.1	
	1000 ÷ 9999	1	
1000A < FS ≤ 3000	0 ÷ 9999	1	

Reactive power (@ 230V, I> 5% FS, cosφ<0.9, f=50.0Hz)

FS clamp	Range [kVar]	Resolution [kVar]	Accuracy
----------	--------------	-------------------	----------

$\leq 10A$	0.000 ÷ 9.999	0.001	$\pm(2.0\%rdg + 7dgt)$
	10.00 ÷ 99.99	0.01	
$10A < FS \leq 200$	0.00 ÷ 99.99	0.01	
	100.0 ÷ 999.9	0.1	
$10A < FS \leq 200$	0.0 ÷ 999.9	0.1	
	1000 ÷ 9999	1	
$1000A < FS \leq 3000$	0 ÷ 9999	1	

Power factor / $\cos\phi$ (@ 230V, I >5%FS)

Range	Resolution	Accuracy
0.70c ÷ 1.00 ÷ 0.70i	0.01	$\pm(2.0\%rdg + 3rdg)$

Voltage harmonics (@ 230V in 1Ph systems, 400V in 3Ph systems)

Range [%]	Resolution [%]	Ordine	Accuracy
0.1 ÷ 100.0	0.1	DC, 01 ÷ 49	$\pm(5.0\%rdg + 5rdg)$

Fundamental frequency: 42 ÷ 69.0 Hz

Harmonics are zeroed at the below conditions::

- DC : DC value <0.5% fundamental value or DC value < 1.0V
- 1° Harmonic: value of 1° Harmonic < 15V
- 2nd ÷ 49th Harmonics: harmonic value <0.5% fundamental value or if value < 1.0V

Current harmonics

Range [%]	Resolution [%]	Order	Accuracy
0.1 ÷ 100.0	0.1	DC, 01 ÷ 49	$\pm(5.0\%rdg + 5rdg)$

Fundamental frequency: 42 ÷ 69.0 Hz

Harmonics are zeroed at the below conditions::

- DC : DC value <0.5% fundamental value or DC value <0.5% FS clamp
- 1° Harmonic: value of 1° Harmonic < 0.5% FS clamp
- 2nd ÷ 49th Harmonics: harmonic value <0.5% fundamental value or if value < 0.5% FS clamp

Voltage anomalies (Phase-Neutral, Phase-PE)

Range [V]	Resolution [V]	Resolution [ms]	Accuracy [V]	Accuracy [ms]
15.0 ÷ 380.0	0.2	20ms	$\pm(1.0\%rdg + 2dgt)$	$\pm 1cycle$

Voltage anomalies (Phase-Phase)

Range [V]	Resolution [V]	Resolution [ms]	Accuracy [V]	Accuracy [ms]
15.0 ÷ 660	0.2	20ms	$\pm(1.0\%rdg + 2dgt)$	$\pm 1cycle$

10.3. REFERENCE GUIDELINES

Safety: IEC/EN61010-1, IEC/EN61557-1

EMC :	IEC/EN61326-1
EMC ambient of use :	industrial, Class A, Group 1
Technical documentation:	IEC/EN61187
Safety of measuring accessories:	IEC/EN61010-031, IEC/EN61010-2-032
Insulation:	double insulation
Pollution level:	2
Protection index:	IP40
Measurement category:	CAT IV 300V to ground, CAT III 350V to ground max 600VAC between inputs
Network quality:	EN50160

10.4. GENERAL CHARACTERISTICS

Mechanical characteristics

Size (L x W x H):	225 x 165 x 75mm ; (9 x 6 x 3in)
Weight (batteries included):	1.2kg ; (42 ounces)

Power supply

Battery type:	6 x 1.2V rechargeable batteries NiMH type AA 6x1.5V alkaline batteries type AA IEC LR06 MN1500
Low battery indication:	low battery symbol  on the display
Recording autonomy:	approx 43 days (IP=15min) approx 2 days (IP=1min) approx 2 hours (IP=2s)
Recharging time:	approx. 12 hours
External adapter:	100-240VAC, 50/60Hz / 15VDC, CAT IV 300V
Auto Power OFF:	after 5 minutes idling (if activated)

Miscellaneous

Display:	TFT, color, capacitive touch-screen, 320x240mm
Aggregation time:	2s to 30min selectable
Memory for snapshots:	999 memory locations, 3 levels of markers
Memory for recordings:	8MB (not expandible), max 49 recordings
Connection to PC:	optical/USB port
No cable connection:	WiFi connection

10.5. ENVIRONMENT

10.5.1. Environmental conditions for use

Reference temperature:	23° ± 5°C ; (73°F ± 41°F)
Operating temperature:	0 ÷ 40°C ; (32°F ÷ 104°F)
Allowable relative humidity:	<80%RH
Storage temperature:	-10 ÷ 60°C ; (14°F ÷ 140°F)
Storage humidity:	<80%RH
Max operating altitude:	2000m (6562ft)

This instrument satisfies the requirements of Low Voltage Directive 2014/35/EU (LVD), EMC Directive 2014/30/EU and Directive RED 2014/53/EU
This instrument satisfies the requirements of European Directive 2011/65/EU (RoHS) and European Directive 2012/19/EU (WEEE)

10.6. ACCESSORIES

See the attached packing list.

11. SERVICE

11.1. WARRANTY CONDITIONS

This instrument is warranted against any material or manufacturing defect, in compliance with the general sales conditions. During the warranty period, defective parts may be replaced. However, the manufacturer reserves the right to repair or replace the product. Should the instrument be returned to the After-sales Service or to a Dealer, transport will be at the Customer's charge. However, shipment will be agreed in advance. A report will always be enclosed to a shipment, stating the reasons for the product's return. Only use original packaging for shipment. Any damage due to the use of non-original packaging material will be charged to the Customer. The manufacturer declines any responsibility for injury to people or damage to property.

The warranty shall not apply in the following cases:

- Repair and/or replacement of accessories and battery (not covered by warranty).
- Repairs that may become necessary as a consequence of an incorrect use of the instrument or due to its use together with non-compatible appliances.
- Repairs that may become necessary as a consequence of improper packaging.
- Repairs which may become necessary as a consequence of interventions performed by unauthorized personnel.
- Modifications to the instrument performed without the manufacturer's explicit authorization.
- Use not provided for in the instrument's specifications or in the instruction manual.

The content of this manual cannot be reproduced in any form without the manufacturer's authorization.

Our products are patented and our trademarks are registered. The manufacturer reserves the right to make changes in the specifications and prices if this is due to improvements in technology.

11.2. SERVICE

If the instrument does not operate properly, before contacting the After-sales Service, please check the conditions of batteries and cables and replace them, if necessary. Should the instrument still operate improperly, check that the product is operated according to the instructions given in this manual. Should the instrument be returned to the After-sales Service or to a Dealer, transport will be at the Customer's charge. However, shipment will be agreed in advance. A report will always be enclosed to a shipment, stating the reasons for the product's return. Only use original packaging for shipment; any damage due to the use of non-original packaging material will be charged to the Customer.

12. THEORETICAL APPENDIXES

12.1. VOLTAGE ANOMALIES

The meter is capable of recording **independently by the aggregation time** all those TRMS values as voltage anomalies (sags, swells), calculated every 20ms, beyond the percentage thresholds of Voltage Reference (Vref) set during the programming from $\pm 3\%$ to $\pm 30\%$ with steps of 1% . These limits remain unchanged throughout the recording period.

The reference are set to:

Nominal Voltage Phase to Neutral: For Single Phase and 4 wires three phase system.

Nominal Voltage Phase to Phase: For 3 wires three phase and ARON system

Example1 → Three Phase 3 wires

Vref = 400V, LIM+= 10%, LIM-=10% =>

High Lim = $400 * [1+(10/100)] = 440V$

Low Lim = $400 * [1-(10/100)] = 360V$

Example2 → Three Phase 4 wires.

Vref = 230V, LIM+= 10%, LIM-=10% =>

High Lim = $230 * [1+(10/100)] = 253V$

Low Lim = $230 * [1-(10/100)] = 207V$

For each event the instrument records (**with visualization only by management software**):

- The number corresponding to the phase (L1, L2 or L3) where the event occurred
- The direction of the event: "UP" (sag) or "DN" (swell)
- The date/time of the event beginning
- The duration of the event, in seconds with a resolution of 20ms
- The minimum (or maximum) value of voltage during the event.

12.2. SUPPLY VOLTAGE UNBALANCE

In normal conditions the supply voltage and the final loads are perfectly balanced. Unbalances are possible in trouble situations (low insulation) and/or phase circuits interruptions. Moreover, in single phase systems, the balance can be only statistic.

In order to design a correct protection installation a thorough study of anomalous conditions on three phase systems was performed. To better understand the meaning of an installation's parameter the theory of symmetric components is fundamental.

From the theory is always true that any tern of vectors can be decomposed in three kind of tern: the direct (positive) symmetric tern, the reversed (negative) symmetric tern and the omopolar (zero) tern.

On the base of this the result is that each unbalanced three phase system can be decomposed in 3 three phase systems which can be reduced to a separate study of three single phase circuits relative to **direct sequence**, **negative sequence** and **zero sequence** respectively.

The EN50160 standard it declares, relative to low voltage systems that "*under normal operating conditions, during each period of one week, 95% of the 10 minute mean rms values of the negative phase sequence component of the supply voltage shall be within the range 0 to 2% of the direct phase sequence component. In some areas with partly single phase or two phase connected customers' installations, unbalanced up to about 3% at three phase supply terminal occur.*" The meter permits the measure and recording of below parameters, which are characteristics of unbalanced degree of an installations:

$$REV\% = \frac{E_i}{E_d} \times 100 = \text{component at negative sequence}$$

$$ZERO\% = \frac{E_0}{E_d} \times 100 = \text{component at zero sequence}$$

where:

E_i = sequence of negative tern, E_d = sequence of direct tern, E_0 = sequence of zero tern

12.3. VOLTAGE AND CURRENT HARMONICS

Any periodical non-sine wave can be represented as a sum of sinusoidal waves having each a frequency that corresponds to an entire multiple of the fundamental, according to the relation:

$$v(t) = V_0 + \sum_{k=1}^{\infty} V_k \sin(\omega_k t + \varphi_k) \quad (1)$$

where: V_0 = average value of $v(t)$
 V_1 = amplitude of the fundamental of $v(t)$
 V_k = amplitude of the k^{th} harmonic of $v(t)$

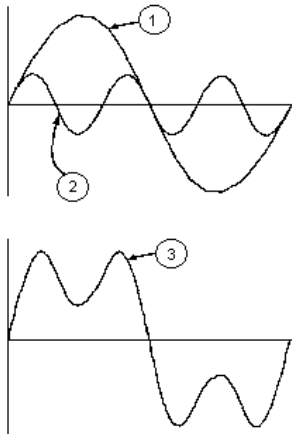

CAPTION:

1. Fundamental
2. Third harmonic
3. Distorted waveform

Fig. 18: Effect of the sum of two multiple frequencies

In the mains voltage, the fundamental has a frequency of 50 Hz, the second harmonic has a frequency of 100 Hz, the third harmonic has a frequency of 150 Hz and so on. Harmonic distortion is a constant problem and should not be confused with short events such as sags, surges or fluctuations.

It can be noted that in (1) the index of the sigma is from 1 to the infinite. What happens in reality is that a signal does not have an unlimited number of harmonics: a number always exists after which the harmonics value is negligible. The EN 50160 standard recommends to stop the index in the expression (1) in correspondence of the 40th harmonic. A fundamental element to detect the presence of harmonics is THD defined as:

$$THD_v = \frac{\sqrt{\sum_{h=2}^{40} V_h^2}}{V_1}$$

This index takes all the harmonics into account. The higher it is, the more distorted the waveform gets.

Limit values for harmonics

EN 50160 guideline fixes the limits for the harmonic voltages, which can be introduced into the network by the power supplier. In normal conditions, during whatever period of a week, 95% of the RMS value of each harmonic voltage, mediated on 10 minutes, will have to be inferior than or equal to the values stated in Table 1. The total harmonic distortion (THD) of the supply voltage (including all the harmonics up to 40th order) must be inferior than or equal to 8%.

Odd harmonics				Even harmonics	
Not multiple of 3		Multiple of 3		Order h	Relative voltage % Max
Order h	Relative voltage % Max	Order h	Relative voltage % Max		
5	6	3	5	2	2
7	5	9	1,5	4	1
11	3,5	15	0,5	6..24	0,5
13	3	21	0,5		
17	2				
19	1,5				
23	1,5				
25	1,5				

Table 1 Limits for the harmonic voltages the supplier may introduce into the network

These limits, theoretically applicable only for the supplier of electric energy, provide however a series of reference values within which the harmonics introduced into the network by the users must be contained.

Presence of harmonics: causes

- Any apparatus that alters the sine wave or uses only a part of such a wave causes distortions to the sine wave and therefore harmonics. All current signals result in some way virtually distorted. The most common situation is the harmonic distortion caused by non-linear loads such as electric household appliances, personal computers or speed control units for motors. Harmonic distortion causes significant currents at frequencies that are odd multiples of the fundamental frequency. Harmonic currents affect considerably the neutral wire of electric installations.
- In most countries, the mains power is three-phase 50/60Hz with a delta primary and star secondary transformers. The secondary generally provides 230V AC from phase to neutral and 400V AC from phase to phase. Balancing the loads on each phase has always represented an headache for electric systems designers
- Until some ten years ago, in a balanced system, the vectorial sum of the currents in the neutral was zero or quite low (given the difficulty of obtaining a perfect balance). The devices were incandescent lights, small motors and other devices that presented linear loads. The result was an essentially sinusoidal current in each phase and a low current on the neutral at a frequency of 50/60Hz
- “Modern” devices such as TV sets, fluorescent lights, video machines and microwave ovens normally draw current for only a fraction of each cycle thus causing non-linear loads and subsequent non-linear currents. All this generates odd harmonics of the 50/60Hz line frequency. For this reason, the current in the transformers of the distribution boxes contains only a 50Hz (or 60Hz) component but also a 150Hz (or 180Hz) component, a 50Hz (or 300Hz) component and other significant components of harmonic up to 750Hz (or 900Hz) and higher
- The vectorial sum of the currents in a balanced system that feeds non-linear loads may still be quite low. However, the sum does not eliminate all current harmonics. The odd multiples of the third harmonic (called “TRIPLENS”) are added together in the neutral and can cause overheating even with balanced loads.

Presence of harmonics: consequences

In general, even harmonics, i.e. the 2nd, 4th etc., do not cause problems. Triple harmonics, odd multiples of three, are added on the neutral (instead of cancelling each other) thus creating a condition of overheating of the wire which is extremely dangerous. Designers should take into consideration the three issues given below when designing a power distribution system that will contain harmonic current:

- The neutral wire must be of sufficient gauge
- The distribution transformer must have an additional cooling system to continue operating at its rated capacity when not suited to the harmonics. This is necessary because the harmonic current in the neutral wire of the secondary circuit circulates in the delta-connected primary circuit. This circulating harmonic current heats up the transformer
- Phase harmonic currents are reflected on the primary circuit and continue back to the power source. This can cause distortion of the voltage wave so that any power factor correction capacitors on the line can be easily overloaded.

The 5th and the 11th harmonic contrast the current flow through the motors making its operation harder and shortening their average life. In general, the higher the ordinal harmonic number, the smaller its energy is and therefore the impact it will have on the devices (except for transformers).

12.4. DEFINITIONS OF POWERS AND POWER FACTORS

In a standard electrical installation powered by three sine voltages the following are to be defined:

Phase Active Power:	(n=1,2,3)	$P_n = V_{nN} \cdot I_n \cdot \cos(\varphi_n)$
Phase Apparent Power:	(n=1,2,3)	$S_n = V_{nN} \cdot I_n$
Phase Reactive Power:	(n=1,2,3)	$Q_n = \sqrt{S_n^2 - P_n^2}$
Phase Power Factor:	(n=1,2,3)	$P_{Fn} = \frac{P_n}{S_n}$
Total Active Power:		$P_{TOT} = P_1 + P_2 + P_3$
Total Reactive Power:		$Q_{TOT} = Q_1 + Q_2 + Q_3$
Total Apparent Power:		$S_{TOT} = \sqrt{P_{TOT}^2 + Q_{TOT}^2}$
Total Power Factor:		$P_{FTOT} = \frac{P_{TOT}}{S_{TOT}}$

where:

V_{nN} = RMS value of voltage between phase n and Neutral.

I_n = RMS value of n phase current.

φ_n = Phase angle between voltage and current of n phase.

In the presence of distorted voltages and currents the previous relations vary as follows:

Phase Active Power:	(n=1,2,3)	$P_{actn} = \sum_{k=0}^{\infty} V_{kn} I_{kn} \cos(\varphi_{kn})$
Phase Apparent Power:	(n=1,2,3)	$P_{appn} = V_{nN} \cdot I_n$
Phase Reactive Power:	(n=1,2,3)	$P_{reactn} = \sqrt{P_{appn}^2 - P_{actn}^2}$
Phase Power Factor:	(n=1,2,3)	$P_{Fn} = \frac{P_{actn}}{P_{appn}}$
Distorted Power Factor	(n=1,2,3)	dPF _n =cos φ_{1n} = phase displacement between the fundamentals of voltage and current of n phase
Total Active Power:		$P_{act} = P_{act1} + P_{act2} + P_{act3}$
Total Reactive Power:		$P_{react} = P_{react1} + P_{react2} + P_{react3}$
Total Apparent Power:		$P_{app} = \sqrt{P_{act}^2 + P_{react}^2}$
Total Power Factor:		$P_F = \frac{P_{act}}{P_{app}}$

where:

V_{kn} = RMS value of kth voltage harmonic between n phase and Neutral.

I_{kn} = RMS value of kth current harmonic of n phase.

φ_{kn} = Phase displacement angle between kth voltage harmonic and kth current harmonic of n phase

NOTES

- It shall be noted that the expression of the phase Reactive Power **with no sine waveforms**, would be wrong. To understand this, it may be useful to consider that both the presence of harmonics and the presence of reactive power produce, among other effects, an increase of line power losses due to the increased current RMS value. With the above given relation the increasing of power losses due to harmonics is added to that introduced by the presence of reactive power. In effect, even if the two phenomena contribute together to the increase of power losses in line, it is not true generally that these causes of power losses are in phase between each other and therefore that can be summed mathematically
- The above given relation is justified by the relative simplicity of its calculation and by the relative discrepancy between the value obtained using this relation and the true value
- It shall also be noted, how, in case of an electric installation with harmonics, another parameter called **displacement Power Factor (Cosphi)** is defined. In practice, this parameter represents the theoretical limit value that can be reached for Power Factor if all the harmonics could be eliminated from the electric installation.

Conventions on powers and power factors

As for the recognition of the type of reactive power, of the type of power factor and of the direction of the active power, the below conventions must be applied. The stated angles are those of phase-displacement of the current compared to the voltage (for example, in the first panel the current is in advance from 0° to 90° compared to the voltage):

Equipment under test = Inductive Generator ←	90°	→ Equipment under test = Capacitive Load
Pact + = 0 Pfc + = -1 Pfi + = -1 PreactC + = 0 Preacti + = 0	Pact - = Pact Pfc - = -1 Pfi - = Pf PreactC - = 0 Preacti - = Preact	Pact + = Pact Pfc + = Pf Pfi + = -1 PreactC + = Q Preacti + = 0
180°		0°
Pact + = 0 Pfc + = -1 Pfi + = -1 PreactC + = 0 Preacti + = 0	Pact - = Pact Pfc - = Pf Pfi - = -1 PreactC - = Preact Preacti - = 0	Pact + = Pact Pfc + = -1 Pfi + = Pf PreactC + = 0 Preacti + = Preact
270°		0°
Equipment under test = Capacitive Generator ←	270°	→ Equipment under test = Inductive Load

where:

Symbol	Description	Remarks
Pact+	Value of the active power +	Positive parameter (user)
Pfc+	Capacitive power factor +	
Pfi+	Inductive power factor +	
PreactC+	Value of the capacitive reactive power +	
Preacti+	Value of the inductive reactive power +	
Pact-	Value of the active power -	Negative parameter (generator)
Pfc-	Capacitive power factor -	
Pfi-	Inductive power factor -	
PreactC-	Value of the capacitive reactive power -	
Preacti-	Value of the inductive reactive power -	
Value	Description	
Pact	The active power (positive or negative) is defined in the panel and therefore acquires the value of the active power in that moment.	

Preact	The reactive power (inductive or capacitive, positive or negative) is defined in the panel and therefore acquires the value of the reactive power in that moment.
Pf	The power factor (inductive or capacitive, positive or negative) is defined in the panel and therefore acquires the value of the power factor in that moment.
0	The active power (positive or negative) or the reactive power (inductive or capacitive, positive or negative) is NOT defined in the panel and therefore acquires a null value.
-1	The power factor (inductive or capacitive, positive or negative) is NOT defined in the panel.

Three phase 3 wire ARON system

In the electrical systems distributed without neutral, the phase voltages and the power factors and phase $\cos\phi$ lose importance. Only the phase to phase voltages, the phase currents and the total powers remain defined.

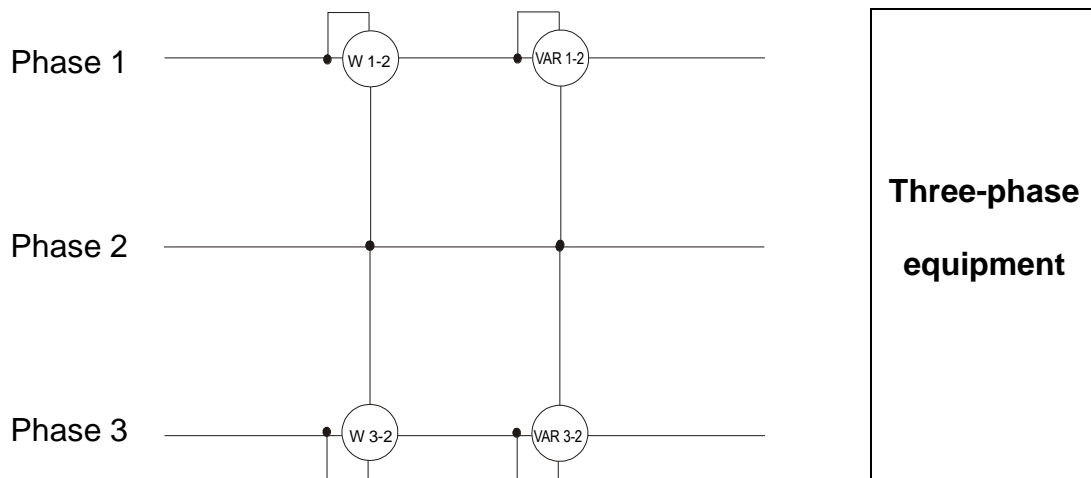

In this case the potential of one of the three phases (for example, phase 2) is taken on as reference potential. The total values of the active, reactive and apparent power are expressed as sum of the indications of the couples of Wattmeters, VARmeters and VAmeters.

$$P_{act} = P_{act12} + P_{act32}$$

$$P_{react} = P_{react12} + P_{react32}$$

$$P_{app} = \sqrt{(P_{act12} + P_{act32})^2 + (P_{react12} + P_{react32})^2}$$

12.5. MEASURING METHOD: OUTLINES

The meter is capable of measuring: voltages, currents, active powers, inductive and capacitive reactive powers, apparent powers, inductive and capacitive power factors, energies, analogical or pulse parameters. All these parameters are analysed in a digital way

for each phase (voltage and current) and calculated based on formulas of the previous sections.

Aggregation time

The storage of all the data would require a huge memory capacity. Therefore we've tried to find out a storage method which permits to compress the information to be saved providing significant data. The selected method is the integration one: after a certain period called "**aggregation time**", which can be set from **2 seconds to 30 minutes**, the meter extracts from the sampled values the following values:

- MINIMUM value of the parameter during the aggregation time (harmonics excluded).
- AVERAGE value of the parameter (intended as arithmetic average of all the values recorded during the aggregation time).
- MAXIMUM value of the parameter during the aggregation time (harmonics excluded).

Only this information (repeated for each parameter to be stored) are saved in the memory along with starting time and date of the aggregation time. Once these data are stored, the instrument restarts to take measurements for a new interval.

12.6. DESCRIPTION OF TYPICAL CONFIGURATIONS

During each recording, **as a not modifiable option**, the instrument always automatically saves, as a standard configuration, besides voltage anomalies, the values of any network parameter depending on the type of selected electric system (see 6.3.1).

The meter allows defining the following typical configurations which can be selected at any moment (see § 6.3.2). The selection of one of these configurations automatically sets **only the necessary** parameters for recording depending on the type of analysis

EN50160	Setting parameters for quality network compliance with guideline EN50160 (see § 12.3)
HARM.	Setting parameters for voltage/current harmonic analysis (see § 12.3)
kWh (Power and Energy)	Setting parameters for Power/Energy measurements (see § 12.4)
DEFAULT	Setting default configuration (all possible recording parameters)

The parameters selected for recording in each of the typical configurations, depending on the type of selected electric system are listed below.

Three-phase system **3 ϕ -4WIRES**, **3 ϕ -3WIRES** and Single-phase **1 ϕ -2WIRES**

EN50160	
Description	Settings
System type:	Not modified
Frequency:	Not modified
Clamp type:	Not modified
Full scale clamp:	Not modified
TV ratio:	Not modified
Start recording:	Not modified
Stop recording:	Not modified
Aggregation time:	10min
Harmonic s recording:	Selected
Voltage anomalies recordings:	Selected
Reference voltage anomalies (Vn):	Not modified
High threshold limit for voltage anomalies:	10%Vn
Low threshold limit for voltage anomalies:	10%Vn
Selected voltage:	V1(Single); V12,V32,V31(3-wires); V1,V2,V3 (4-wires)
Voltage harmonics:	THD%,DC,01,02... 49
Voltage unbalance:	Rev%, Zero% (4-wires), Rev% (3-wires)
Voltage frequency:	Selected
Current, powers, energie, power factors:	Not selected

Table 2: List of parameters saved in EN50160 typical configuration

HARM	
Description	Settings
System type:	Not modified
Frequency:	Not modified

Clamp type:	Not modified
Full scale clamp:	Not modified
TV ratio:	Not modified
Start recording:	Not modified
Stop recording:	Not modified
Aggregation time:	10min
Voltage anomalies recordings:	Selected
Reference voltage anomalies (Vn):	Not modified
High threshold limit for voltage anomalies:	Not modified
Low threshold limit for voltage anomalies:	Not modified
Harmonic s recording:	Selected
Selected voltage:	V1(Single); V12,V32,V31(3-wires); V1,V2,V3 (4-wires)
Voltage harmonics::	THD%,DC,01,02... 49
Voltage unbalance:	Not selected
Voltage frequency:	Selected
Selected current	I1 (Single); I1,I2,I3 (3-wires); I1,I2,I3,In (4-wires)
Current harmonics:	THD%,DC,01,02... 49
Powers, energie, power factors:	Not selected

Table 3: List of parameters saved in HARMONICS typical configuration

kWh (POWER & ENERGY)	
Description	Settings
System type:	Not modified

Frequency:	Not modified
Clamp type:	Not modified
Full scale clamp:	Not modified
TV ratio:	Not modified
Start recording:	Not modified
Stop recording:	Not modified
Aggregation time:	15min
Voltage anomalies recordings:	Selected
Reference voltage anomalies (Vn):	Not modified
High threshold limit for voltage anomalies:	Not modified
Low threshold limit for voltage anomalies:	Not modified
Harmonic s recording:	Not selected
Selected voltage:	V1(Single); V12,V32,V31(3-wires); V1,V2,V3 (4-wires)
Voltage frequency:	Selected
Voltage unbalance:	Not selected
Selected current	I1 (Single); I1,I2,I3 (3-wires); I1,I2,I3,In (4-wires)
Selected powers	P1+, P1-, Q1i+, Q1i-, Q1c+, Q1c-, S1+, S1- (Single) Pt+, Pt-, P1+, P1-, P2+, P2-, P3+, P3- Qti+, Qti-, Qtc+, Qtc-, Q1i+, Q1i-, Q1c+, Q1c-, Q2i+, Q2i-, Q2c+, Q2c-, Q3i+, Q3i-, Q3c+, Q3c- St+, St-, S1+, S1-, S2+, S2-, S3+, S3- (3-wire, 4-wires)
Selected energies	Ea1+, Ea1-, Er1i+, Er1i-, Er1c+, Er1c-, Es1+, Es1- (Single) Eat+, Eat-, Ea1+, Ea1-, Ea2+, Ea2-, Ea3+, Ea3- Erti+, Erti- Ertc+, Ertc-, Er1i+, Er1i-, Er1c+, Er1c-, Er2i+, Er2i-, Er2c+, Er2c- Er3i+, Er3i-, Er3c+, Er3c- Est+, Est-, Es1+, Es1-, Es2+, Es2- Es3+, Es3- (3-wires, 4-wires)
Selected power factors, $\cos\varphi$	Pf1i+, Pf1i-, Pf1c+, Pf1c-, dPf1i+, dPf1i-, dPf1c+, dPf1c- (Single) Pfti+, Pfti-, Pftc+, Pftc-, Pf1i+, Pf1i-, Pf1c+, Pftc-, Pf2i+, Pf2i- Pf2c+, Pf2c-, Pf3i+, Pf3i-, Pf3c+, Pf3c-, dPfti+, dPfti-, dPftc+, dPftc- dPf1i+, dPf1i-, dPf2c+, dPf2c-, dPf3i+, dPf3i-, dPf3c+, dPf3c- (3-wires, 4-wires)

Table 4: List of parameters saved in POWER&ENERGY typical configuration

DEFAULT	
Description	Settings
System type:	Not modified
Frequency:	Not modified

Clamp type:	Not modified
Full scale clamp:	Not modified
TV ratio:	Not modified
Start recording:	Not modified
Stop recording:	Not modified
Aggregation time:	Not modified
Voltage anomalies recordings:	Selezionata
Reference voltage anomalies (Vn):	Not modified
High threshold limit for voltage anomalies:	Not modified
Low threshold limit for voltage anomalies:	Not modified
Harmonic recording:	Selected
Selected voltage:	V1(Single); V12,V32,V31(3-wires); V1,V2,V3 (4-wires)
Voltage harmonics:	THD%,DC,01,02... 49
Voltage unbalance:	Rev%, Zero% (4-wires), Rev% (3-wires)
Voltage frequency:	Selected
Selected current	I1 (Single); I1,I2,I3 (3-wires); I1,I2,I3,In (4-wires)
Current harmonics	THD%,DC,01,02... 49
Selected powers	P1+, P1-, Q1i+, Q1i-, Q1c+, Q1c-, S1+, S1- (Single)
	Pt+, Pt-, P1+, P1-, P2+, P2-,P3+, P3- Qti+, Qti-,Qtc+,Qtc-,Q1i+, Q1i-,Q1c+,Q1c-,Q2i+,Q2i-,Q2c+,Q2c-,Q3i+,Q3i-,Q3c+,Q3c- St+,St-, S1+, S1-,S2+,S2-,S3+,S3- (3-wire, 4-wires)
Selected energies	Ea1+, Ea1-, Er1i+,Er1i-,Er1c+,Er1c-,Es1+,Es1- (Single)
	Eat+, Eat-, Ea1+, Ea1-, Ea2+, Ea2-,Ea3+, Ea3- Erti+, Erti- Ertc+,Ertc-,Er1i+,Er1i-,Er1c+,Er1c-,Er2i+,Er2i-,Er2c+,Er2c- Er3i+,Er3i-,Er3c+,Er3c- Est+,Est-,Es1+, Es1-,Es2+,Es2- Es3+,Es3- (3-wires, 4-wires)
Selected power factors, $\cos\varphi$	Pf1i+,Pf1i-,Pf1c+,Pf1c-,dPf1i+,dPf1i-,dPf1c+,dPf1c- (Single)
	Pfti+,Pfti-,Pftc+,Pftc-,Pf1i+,Pf1i-,Pf1c+,Pftc-,Pf2i+,Pf2i- Pf2c+,Pf2c-,Pf3i+,Pf3i-,Pf3c+,Pf3c-,dPfti+,dPfti-,dPftc+,dPftc- dPf1i+,dPf1i-,dPf2c+,dPf2c-,dPf3i+,dPf3i-,dPf3c+,dPf3c- (3-wires, 4-wires)

Table 5: List of standard parameters saved in a DEFAULT typical configuration

Three-phase 4-wires **3 ϕ -High Leg** systems – for USA systems

EN50160

Description	Settings
System type:	Not modified
Frequency:	Not modified
Clamp type:	Not modified
Full scale clamp:	Not modified
TV ratio:	Not modified
Start recording:	Not modified
Stop recording:	Not modified
Aggregation time:	10min
Harmonic recording::	Selected
Voltage anomalies recording:	Selected
Reference voltage anomalies (Vn):	Not modified
High threshold limit for voltage anomalies:	10%Vn
Low threshold limit for voltage anomalies:	10%Vn
Selected voltage:	V1,V2,V3,V12,V32,V31
Voltage harmonics:	THD%,DC,01,02... 49
Voltage unbalance:	Rev%
Voltage frequency:	Selected
Selected current	Not selected
Selected powers	Not selected

Table 6: List of standard parameters saved in a EN50160 typical configuration

HARM.	
Description	Settings
System type:	Not modified
Frequency:	Not modified
Clamp type:	Not modified
Full scale clamp:	Not modified
TV ratio:	Not modified
Start recording:	Not modified
Stop recording:	Not modified
Aggregation time:	10min
Voltage anomalies recording:	Selected
Reference voltage anomalies (Vn)	Not modified
High threshold limit for voltage anomalies:	Not modified
Low threshold limit for voltage anomalies:	Not modified
Harmonic recording	Selected
Selected voltage:	V1,V2,V3, V12,V32,V31
Voltage harmonics:	THD%,DC,01,02... 49
Voltage unbalance:	Not selected
Voltage frequency:	Selected
Selected current	I1,I2,I3,In
Current harmonics:	THD%,DC,01,02... 49
Powers, Energie, power factors	Not selected

Table 7: List of parameters saved in HARMONICS typical configuration

kWh (POWER & ENERGY)	
Description	Description
System type:	Not modified

Frequency:	Not modified
Clamp type:	Not modified
Full scale clamp:	Not modified
TV ratio:	Not modified
Start recording:	Not modified
Stop recording:	Not modified
Aggregation time:	15min
Voltage anomalies recording:	Selected
Reference voltage anomalies (Vn)	Not modified
High threshold limit for voltage anomalies:	Not modified
Low threshold limit for voltage anomalies:	Not modified
Harmonic recording	Not selected
Selected voltage:	V1,V2,V3, V12,V32,V31
Voltage harmonics:	Selected
Voltage unbalance:	Not selected
Voltage frequency:	Selected
Selected current	I1,I2,I3,In
Selected powers	Pt+, Pt-, Qti+, Qti-,Qtc+,Qtc-,St+,St-
Selected energies	Eat+,Eat-,Erti+,Erti-,Ertc+,Ertc-
Selected power factors, $\cos\varphi$	Pfti+,Pfti-,Pftc+,Pftc-,dPfti+,dPfti-,dPftc+,dPftc-

Table 8: List of parameters saved in POWER&ENERGY typical configuration

DEFAULT	
Description	Description
System type:	Not modified
Frequency:	Not modified
Clamp type:	Not modified
Full scale clamp:	Not modified
TV ratio:	Not modified
Start recording:	Not modified
Stop recording:	Not modified
Aggregation time:	Not modified
Voltage anomalies recording:	Selected
Reference voltage anomalies (Vn)	Not modified
High threshold limit for voltage anomalies:	Not modified
Low threshold limit for voltage anomalies:	Not modified
Harmonic recording	Selected
Selected voltage:	V1,V2,V3, V12,V32,V31
Voltage harmonics	THD%,DC,01,02... 49
Voltage unbalance:	Rev%
Voltage frequency::	Selected
Selected current	I1,I2,I3,In
Current harmonics:	THD%,DC,01,02... 49
Selected powers	Pt+, Pt-, Qti+, Qti-,Qtc+,Qtc-,St+,St-
Selected energies	Eat+,Eat-,Erti+,Erti-,Ertc+,Ertc-
Selected power factors, $\cos\varphi$	Pfti+,Pfti-,Pftc+,Pftc-,dPfti+,dPfti-,dPftc+,dPftc-

Table 9: List of standard parameters saved in a DEFAULT typical configuration

Three-phase 3-wires 3 ϕ -Y Open, 3 ϕ -2EI. 1/2, 1 ϕ -CentralPoint – for USA systems

EN50160

Description	Description
System type:	Not modified
Frequency:	Not modified
Clamp type:	Not modified
Full scale clamp:	Not modified
TV ratio:	Not modified
Start recording:	Not modified
Stop recording:	Not modified
Aggregation time:	10min
Harmonic recording:	Selected
Voltage anomalies recording:	Selected
Reference voltage anomalies (Vn)	Not modified
High threshold limit for voltage anomalies:	10%Vn
Low threshold limit for voltage anomalies:	10%Vn
Selected voltage:	V1,V2,V12
Voltage harmonics	THD%,DC,01,02... 49
Voltage unbalance:	Not selected
Voltage frequency::	Selected
Selected current	Not selected
Selected powers	Not selected

Table 10: List of standard parameters saved in a EN50160 typical configuration

HARM.	
Description	Description
System type:	Not modified
Frequency:	Not modified
Clamp type:	Not modified
Full scale clamp:	Not modified
TV ratio:	Not modified
Start recording:	Not modified
Stop recording:	Not modified
Aggregation time:	10min
Voltage anomalies recording:	Selected
Reference voltage anomalies (Vn)	Not modified
High threshold limit for voltage anomalies:	Not modified
Low threshold limit for voltage anomalies:	Not modified
Harmonic recording	Selected
Selected voltage:	V1,V2,V12
Voltage harmonics	THD%,DC,01,02... 49
Voltage unbalance:	Not selected
Voltage frequency::	Selected
Selected current	I1,I2,I _n
Current harmonics:	THD%,DC,01,02... 49
Powers, Energie, power factors	Not selected

Table 11: List of parameters saved in HARMONICS typical configuration

kWh (POWER & ENERGY)	
Description	Description
System type:	Not modified
Frequency:	Not modified

Clamp type:	Not modified
Full scale clamp:	Not modified
TV ratio:	Not modified
Start recording:	Not modified
Stop recording:	Not modified
Aggregation time:	15min
Voltage anomalies recording:	Selected
Reference voltage anomalies (Vn)	Not modified
High threshold limit for voltage anomalies:	Not modified
Low threshold limit for voltage anomalies:	Not modified
Harmonic recording	Not selected
Selected voltage:	V1,V2,V12
Voltage frequency:	Selected
Voltage unbalance:	Not selected
Selected current	I1,I2,I _n
Selected powers	Pt+, Pt-, Qti+, Qti-, Qtc+, Qtc-, St+, St- P1+, P1-, Q1i+, Q1i-, Q1c+, Q1c-, S1+, S1- P2+, P2-, Q2i+, Q2i-, Q2c+, Q2c-, S2+, S2-
Selected energies	Eat+, Eat-, Erti+, Erti-, Ertc+, Ertc- Ea1+, Ea1-, Er1i+, Er1i-, Er1c+, Er1c-, Es1+, Es1- Ea2+, Ea2-, Er2i+, Er2i-, Er2c+, Er2c-, Es2+, Es2-
Selected power factors, cosφ	Pfti+, Pfti-, Pftc+, Pftc-, dPfti+, dPfti-, dPftc+, dPftc- Ppf1i+, Ppf1i-, Ppf1c+, Ppf1c-, dPpf1i+, dPpf1i-, dPpf1c+, dPpf1c- Ppf2i+, Ppf2i-, Ppf2c+, Ppf2c-, dPpf2i+, dPpf2i-, dPpf2c+, dPpf2c-

Table 12: List of parameters saved in POWER&ENERGY typical configuration

DEFAULT	
Description	Description
System type:	Not modified
Frequency:	Not modified

Clamp type:	Not modified
Full scale clamp:	Not modified
TV ratio:	Not modified
Start recording:	Not modified
Stop recording:	Not modified
Aggregation time:	Not modified
Voltage anomalies recording:	Selected
Reference voltage anomalies (Vn)	Not modified
High threshold limit for voltage anomalies:	Not modified
Low threshold limit for voltage anomalies:	Not modified
Harmonic recording:	Selected
Selected voltage:	V1,V2,V12
Voltage harmonics:	THD%,DC,01,02... 49
Voltage unbalance:	Not selected
Voltage frequency:	Selected
Selected current	I1,I2,In
Current harmonics:	THD%,DC,01,02... 49
Selected powers	Pt+, Pt-, Qti+, Qti-, Qtc+, Qtc-, St+, St- P1+, P1-, Q1i+, Q1i-, Q1c+, Q1c-, S1+, S1- P2+, P2-, Q2i+, Q2i-, Q2c+, Q2c-, S2+, S2-
Selected energies	Eat+, Eat-, Erti+, Erti-, Ertc+, Ertc- Ea1+, Ea1-, Er1i+, Er1i-, Er1c+, Er1c-, Es1+, Es1- Ea2+, Ea2-, Er2i+, Er2i-, Er2c+, Er2c-, Es2+, Es2-
Selected power factors, $\cos\varphi$	Pfti+, Pfti-, Pftc+, Pftc-, dPfti+, dPfti-, dPftc+, dPftc- Pf1i+, Pf1i-, Pf1c+, Pf1c-, dPf1i+, dPf1i-, dPf1c+, dPf1c- Pf2i+, Pf2i-, Pf2c+, Pf2c-, dPf2i+, dPf2i-, dPf2c+, dPf2c-

Table 13: List of standard parameters saved in a DEFAULT typical configuration

Three-phase 3-wire 3ϕ -ARON and 3ϕ - Δ Open (USA system)

EN50160	
Description	Description
System type:	Not modified
Frequency:	Not modified
Clamp type:	Not modified
Full scale clamp:	Not modified
TV ratio:	Not modified
Start recording:	Not modified
Stop recording:	Not modified
Aggregation time:	10min
Harmonic recording::	Selected
Voltage anomalies recording:	Selected
Reference voltage anomalies (Vn)	Not modified
High threshold limit for voltage anomalies:	10%Vn
Low threshold limit for voltage anomalies:	10%Vn
Selected voltage:	V12,V23,V31
Voltage harmonics:	THD%,DC,01,02... 49
Voltage unbalance:	Rev%
Voltage frequency:	Selected
Selected current	Not selected
Powers, Energie, power factors	Not selected

Table 14: List of standard parameters saved in a EN50160 typical configuration

HARM.	
Description	Description
System type:	Not modified
Frequency:	Not modified
Clamp type:	Not modified
Full scale clamp:	Not modified
TV ratio:	Not modified
Start recording:	Not modified
Stop recording:	Not modified
Aggregation time:	10min
Voltage anomalies recording:	Selected
Reference voltage anomalies (Vn)	Not modified
High threshold limit for voltage anomalies:	Not modified
Low threshold limit for voltage anomalies:	Not modified
Harmonic recording:	Selected
Selected voltage:	V12,V23,V31
Voltage harmonics:	THD%,DC,01,02... 49
Voltage unbalance:	Not selected
Voltage frequency:	Selected
Selected current	I1,I2,I3
Current harmonics:	THD%,DC,01,02... 49
Powers, Energie, power factors	Not selected

Table 15: List of parameters saved in HARMONICS typical configuration

kWh (POWER & ENERGY)	
Description	Description

System type:	Not modified
Frequency:	Not modified
Clamp type:	Not modified
Full scale clamp:	Not modified
TV ratio:	Not modified
Start recording:	Not modified
Stop recording:	Not modified
Aggregation time:	15min
Voltage anomalies recording:	Selected
Reference voltage anomalies (Vn)	Not modified
High threshold limit for voltage anomalies:	Not modified
Low threshold limit for voltage anomalies:	Not modified
Harmonic recording:	Not selected
Selected voltage:	V12,V23,V31
Voltage frequency:	Selected
Voltage unbalance:	Not selected
Selected current	I1,I2,I3
Selected powers	Pt+, Pt-, Qti+, Qti-, Qtc+, Qtc-, St+, St- P12+, P12-, Q12i+, Q12i-, Q12c+, Q12c-, S12+, S12- P32+, P32-, Q32i+, Q32i-, Q32c+, Q32c-, S32+, S32-
Selected energies	Eat+, Eat-, Ea12+, Ea12-, Ea32+, Ea32-, Erti+, Erti-, Ertc+, Ertc-, Er12i+, Er12i-, Er12c+, Er12c-, Er32i+, Er32i-, Er32c+, Er32c- Est+, Est-, Es12+, Es12-, Es32+, Es32-
Selected power factors, $\cos\varphi$	Pfti+, Pfti-, Pftc+, Pftc-, Pf12i+, Pf12i-, Pf12c+, Pf12c-, Pf32i+, Pf32i- Pf32c+, Pf32c-, dPfti+, dPfti-, dPftc+, dPftc-, dPf12i+, dPf12i- dPf12c+, dPf12c-, dPf32i+, dPf32i-, dPf32c+, dPf32c-

Table 16: List of parameters saved in POWER&ENERGY typical configuration

DEFAULT	
Description	Description
System type:	Not modified

Frequency:	Not modified
Clamp type:	Not modified
Full scale clamp:	Not modified
TV ratio:	Not modified
Start recording:	Not modified
Stop recording:	Not modified
Aggregation time:	Not modified
Voltage anomalies recording:	Selected
Reference voltage anomalies (Vn)	Not modified
High threshold limit for voltage anomalies:	Not modified
Low threshold limit for voltage anomalies:	Not modified
Harmonic recording::	Selected
Tensione selezionata:	V12,V23,V31
Voltage harmonics:	THD%,DC,01,02... 49
Voltage unbalance:	Rev%
Voltage frequency:	Selected
Selected current	I1,I2,I3
Current harmonics:	THD%,DC,01,02... 49
Selected powers	Pt+, Pt-, Qti+, Qti-, Qtc+, Qtc-, St+, St- P12+, P12-, Q12i+, Q12i-, Q12c+, Q12c-, S12+, S12- P32+, P32-, Q32i+, Q32i-, Q32c+, Q32c-, S32+, S32-
Selected energies	Eat+, Eat-, Ea12+, Ea12-, Ea32+, Ea32-, Erti+, Erti-, Ertc+, Ertc-, Er12i+, Er12i-, Er12c+, Er12c-, Er32i+, Er32i-, Er32c+, Er32c- Est+, Est-, Es12+, Es12-, Es32+, Es32-
Selected power factors, $\cos\varphi$	Pfti+, Pfti-, Pftc+, Pftc-, Pf12i+, Pf12i-, Pf12c+, Pf12c-, Pf32i+, Pf32i- Pf32c+, Pf32c-, dPfti+, dPfti-, dPftc+, dPftc-, dPf12i+, dPf12i- dPf12c+, dPf12c-, dPf32i+, dPf32i-, dPf32c+, dPf32c-

Table 17: List of standard parameters saved in a DEFAULT typical configuration



HT ITALIA SRL

Via della Boaria, 40
48018 – Faenza (RA) – Italy
T +39 0546 621002 | F +39 0546 621144
M info@ht-instruments.com | www.ht-instruments.it

WHERE
WE ARE



HT INSTRUMENTS SL

C/ Legalitat, 89
08024 Barcelona – Spain
T +34 93 408 17 77 | F +34 93 408 36 30
M info@htinstruments.es | www.ht-instruments.com/es-es/

HT INSTRUMENTS GmbH

Am Waldfriedhof 1b
D-41352 Korschenbroich – Germany
T +49 (0) 2161 564 581 | F +49 (0) 2161 564 583
M info@htinstruments.de | www.ht-instruments.de