

HOBOnet® RX Wireless Sensor Network

HOBO RX3000 RXW Manager (RXMOD-RXW-xxx) Manual



HOBO RX3000 RXW Manager

Models:

- RXMOD-RXW-900 (US)
- RXMOD-RXW-868 (Europe)
- RXMOD-RXW-921 (Taiwan)
- RXMOD-RXW-922 (Australia/NZ)

Items Included:

- Cable ties
- Screws

The HOBOnet RX3000 RXW Manager is a module and mote designed to work with the HOBOnet (HOBO® RX) Wireless Sensor Network. When the RXW Manager module is installed in an RX3000 station, data is transmitted wirelessly from sensor motes across the network to the RX3000 station and then uploaded to HOBOLink® web-based software. You can use HOBOLink to monitor the network, view graphs, set up alarms, download data, and more.

Specifications

| | |
|------------------------------------|---|
| Operating Temperature Range | -25° to 60°C (-13° to 140°F) |
| Radio Power | 12.6 mW (+11 dBm) non-adjustable |
| Transmission Range | Reliable connection to 457.2 m (1,500 ft) line of sight at 1.8 m (6 ft) high Reliable connection to 609.6 m (2,000 ft) line of sight at 3 m (10 ft) high |
| Wireless Data Standard | IEEE 802.15.4 |
| Radio Operating Frequencies | RXMOD-RXW-900: 904–924 MHz RXMOD-RXW-868: 866.5 MHz RXMOD-RXW-921: 921 MHz RXMOD-RXW-922: 916–924 MHz |
| Modulation Employed | OQPSK (Offset Quadrature Phase Shift Keying) |
| Data Rate | Up to 250 kbps, non-adjustable |
| Duty Cycle | <1% |
| Maximum Number of Motes | Up to 50 wireless sensors or 336 data channels per one HOBO RX station |
| Power Source | Powered by the RX3000 station |
| Dimensions | Mote: 16.2 x 8.59 x 4.14 cm (6.38 x 3.38 x 1.63 inches) Cable length: 2 m (6.56 ft) |
| Weight | Mote: 159 g (5.62 oz) |
| Materials | Mote: PCPBT, silicone rubber seal |
| Environmental Rating | Mote: IP67, NEMA 6 |
| Compliance Marks | <p>FC RXMOD-RXW-900: See last page</p> <p>CE RXMOD-RXW-868: The CE Marking identifies this product as complying with all relevant directives in the European Union (EU).</p> <p>CCC RXMOD-RXW-921: See last page</p> <p>RoHS RXMOD-RXW-922: See last page</p> |

Components and Operation

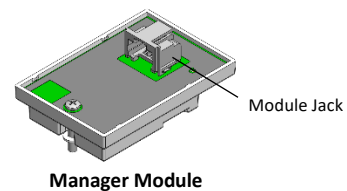
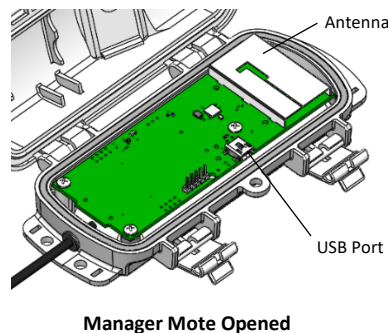
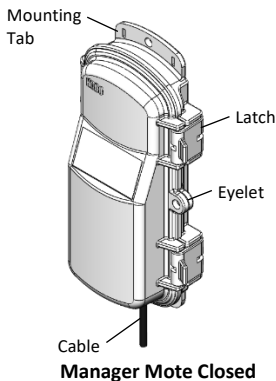

The RXW Manager consists of a mote with a cable attached that is plugged into a module, which is installed in the RX3000 station. These are the components of the mote and module.

Mounting Tab: Use the tabs at the top and bottom of the mote to mount it (see *Deploying and Mounting*).

Cable: Use this cable to connect the mote to the module.

Eyelet: Use this eyelet to attach a 3/16 inch padlock to the mote for security.

Latch: Use the two latches to open and close the mote door.

Antenna: This is the built-in antenna for the radio communications across the RX Wireless Sensor Network.

USB Port: Use this port to connect to the mote to a computer via USB cable if you need to update the firmware (see *Updating Mote Firmware*).

Module Jack: Use this jack to connect the mote to the module with the cable attached to the mote (see *Installing the Module*).

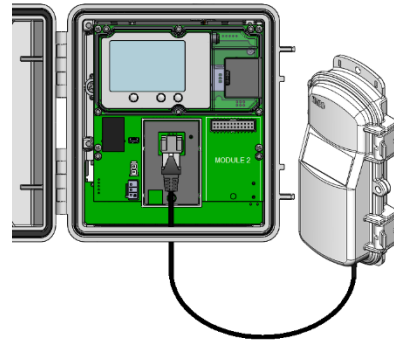

Installing the Module

The module must be installed in an RX3000 station before the motes in the HOBONet Wireless Sensor Network can join the network.

Important: If you have not already registered the RX3000 station with HOBOLink and set up the station communications, follow the instructions in the RX3000 Quick Start at www.onsetcomp.com/support/manuals/18254-MAN-QSG-RX3000.

To add a module:

1. Stop the station if it is currently logging. Press the Connect button and wait for the station to connect to HOBOLink so that all the latest data is offloaded before adding a new module.

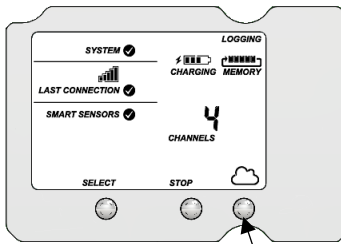

Press Connect if the station was logging to upload the latest data

2. Once the station is done connecting to HOBOLink, power it down by disconnecting the battery and unplugging any charging device.
3. Insert the connector on the back of the module into the receptacle in the left or right module slot.

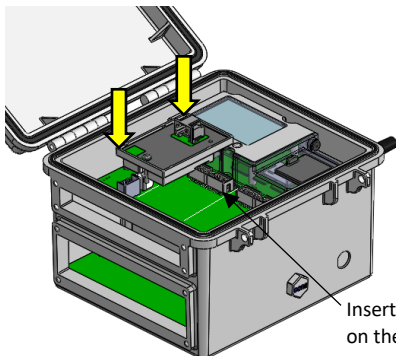

Insert the connectors on the module here

4. Using a Phillips-head screwdriver, tighten the screw at the bottom of the module.
5. Plug the cable from the RXW Manager mote into the jack on the module, making sure the cable is inserted through the bottom of the station case. Do not reconnect the power on the station until the mote is plugged in as shown.

6. Plug in the battery and then the charging device, and wait for the station to power up. Verify that the new module is listed on the LCD screen with a checkmark. Because the module was installed in the left slot in this example, it is listed on the LCD as module 1.

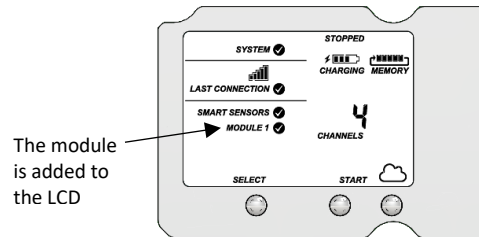

The module is added to the LCD

7. The station should automatically connect to HOBOLink (press the Connect button on the station if it does not). Check your station's page in HOBOLink to make sure the new module is listed.
8. If you added the module to an RX3000 station that was previously in use, you will need to update the station firmware. (If you have a new station, go to the next step.) To update the firmware:

- a. In HOBOLink, go to Devices > RX Devices and click your station name.
- b. On the station page, click Overview and scroll down to Device Information.
- c. On the General tab under the Firmware Version, click the firmware  upgrade link.



Click this link to upgrade the station firmware

- d. Select Upgrade on Next Connection and click Save.
- e. Press the Connect button on the station.

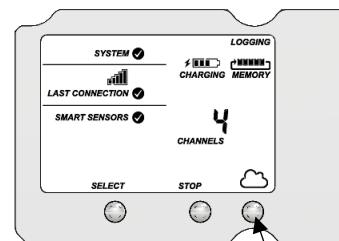

Press Connect to connect to HOBOLink and start the firmware upgrade

- f. Wait for the firmware upgrade to complete. The upgrade icon should be gone in HOBOLink once the upgrade is successful. If the station firmware is not successfully installed, it could be because there is an interruption in cellular service or poor signal strength. Contact Onset Technical Support at 1-800-LOGGERS, 508-759-9500, or www.onsetcomp.com/support/contact for help.
9. Set the logging interval for the module in HOBOLink. Go to Devices > RX Devices, select the  icon next to your station, and select Module/Sensor Configuration. Select Module <1 or 2>: Wireless Sensors Logging, enter a logging interval (how often the sensor motes will record data), and click Save. Press the Start button on the RX3000 station to begin logging.

WARNING: If you inadvertently install modules while the power is on, you must disconnect and then reconnect the battery and charging device to guarantee proper operation. In addition, if you did not plug the manager mote into the module while the power was off, it may not be recognized by the station. Disconnect and reconnect the battery and charging device.

The station is ready for motes to be added to the network. Make sure the mote is in a vertical, upright position and within range of the station while they join the network. Refer to the specific sensor mote or repeater manual for details on adding motes. Note that once all motes are added to the network, the total channel count on the RX3000 station LCD for the RXW Manager module will represent all measurement channels plus a battery channel for each mote in the RX Wireless Sensor Network.

See the HOBOLink Help for details on how to change the logging and connection intervals, view data, check mote status, add the mote to a map, and more.

When the station is deployed, make sure that the RXW Manager cable and all other cables and wires are routed through weatherproof cable channels. Refer to the RX3000 manual at www.onsetcomp.com/manual/rx3000 for details on using the weatherproof cable channel.

Deployment and Mounting

- Use cable ties or screws to mount the mote via the holes on the mounting tabs.
- Make sure the mote remains in a vertical position once it is placed in its deployment location for optimal network communications.
- Make sure the mote door is closed, with both latches fully locked to ensure a watertight seal.
- Consider using a 3/16 inch padlock to restrict access to the mote. With the mote door closed, hook a padlock through the eyelet on the right side of the door and lock it.
- Mount the manager as high as possible above the RX3000 station to increase the radio signal and line of sight.
- Make sure the RXW Manager cable is hanging straight down and not pulled tightly to the side to connect to the station.

Tips for Setting up the HOBONet Wireless Sensor Network

- Stay close to the RX3000 station when adding motes to the wireless network because you will need to access both the station and the mote at the same time. After the mote has successfully joined the wireless network, you can then move it to its deployment location.
- Check the signal strength on the mote LCD on the location where you want to place the mote. If there is only one or two bars on the signal strength indicator, consider moving the mote to a location where the signal strength is stronger.
- Make sure motes are mounted a minimum of 1.8 m (6 feet) above the ground or vegetation to help maximize distance and signal strength as shown below.

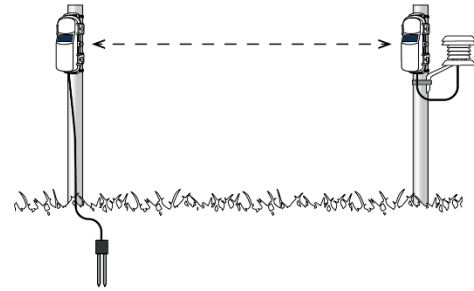

- Consider using a plastic pole such as PVC to mount the motes.
- Make sure each sensor mote and repeater is positioned so that the built-in solar panel receives optimal sunlight throughout each season as shown below. It may be necessary to periodically adjust the mote position as the path of the sunlight changes throughout the year or if tree and leaf growth alters the amount of sunlight reaching the solar panel.

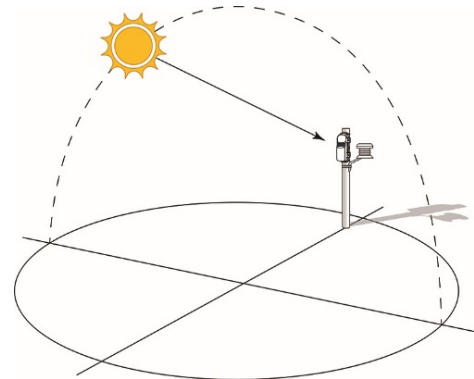

- Obstructions between motes can prevent reliable network communication. If the mote is blocked by a small obstruction (e.g. a pole, the RX3000 station, shrubbery), then move the mote to a location where the obstruction is not blocking the path to the nearest mote. If there is a change in elevation between motes or a large obstruction is in the way (e.g. a building or tree), then either reposition the mote until there is full line of sight to the next mote or add a repeater between them.

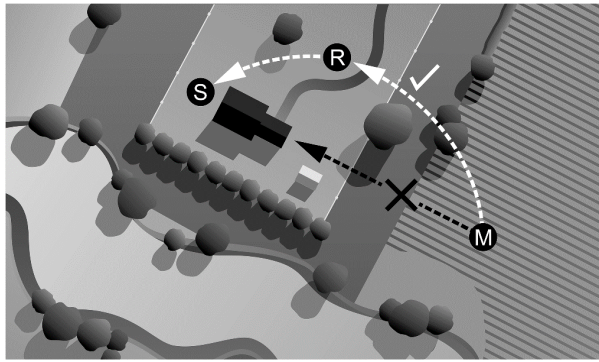

S Station R Repeater M Mote

- There should not be more than five motes in any direction at their maximum transmission range from the RXW Manager. Data logged by a wireless sensor must travel or “hop” across the wireless network from one mote to the next until it ultimately reaches the RXW Manager at the RX3000 station. To make sure the data can successfully travel across the network, the mote should not be more than five hops away from the manager.
- The HOBOnet Wireless Sensor Network can support up to 50 wireless sensors or 336 data channels per one HOBO RX station.
- Use the Map feature in HOBOLink for a bird’s eye view of the network and wireless paths. See the HOBOLink Help for details on this and other ways to monitor the status of your network and sensor data.



Maintenance

The mote is designed for outdoor use, but should be inspected periodically. When inspecting the mote, do the following:

- Verify the mote is free of visible damage or cracks.
- Make sure the mote is clean. Wipe off any dust or grime with a damp cloth.
- Wipe off any water before opening the mote.
- Make sure the interior seal is intact and the latches are fully locked when the mote door is closed.

Updating RXW Manager Firmware

If a new firmware version is available for the module, use HOBOLink to download the file to your computer.

1. In HOBOLink, go to Devices, then RX Devices, and click your station name.
2. On the station page, click Overview and scroll down to Device Information.
3. Click the Wireless tab. This icon  appears next to the module if there is a new version of firmware available.
4. Click the firmware  upgrade link. Click Download and save the firmware .bin file to your computer.

5. Connect the mote to the computer with a USB cable (open the mote door and use the USB port to the right of the LCD). The blue LED is illuminated while connected.
6. The mote appears as a new storage device in the computer’s file storage manager. Copy the downloaded firmware file to the new storage device (the mote). The blue LED will blink slowly while the file is copying.
7. After the file is copied to the mote, the LED will stop blinking and remain a steady blue. Eject the storage device from the computer and disconnect the cable from the mote. The firmware installation process will begin automatically on the mote. The blue LED will blink rapidly while the firmware is installed. Once the firmware installation is complete, the LCD symbols return and the mote will automatically rejoin the network.

Notes:

- Mac® users: A message may appear indicating the disk has not ejected properly when disconnecting the mote from the computer. The mote is operational and you can ignore the message.
- If the blue LED turns off abruptly while copying the file or installing the firmware, a problem has occurred. Contact Onset Technical Support for help.

Federal Communication Commission Interference Statement

This equipment has been tested and found to comply with the limits for a Class B digital device, pursuant to Part 15 of the FCC Rules. These limits are designed to provide reasonable protection against harmful interference in a residential installation. This equipment generates uses and can radiate radio frequency energy and, if not installed and used in accordance with the instructions, may cause harmful interference to radio communications. However, there is no guarantee that interference will not occur in a particular installation. If this equipment does cause harmful interference to radio or television reception, which can be determined by turning the equipment off and on, the user is encouraged to try to correct the interference by one of the following measures:

- Reorient or relocate the receiving antenna
- Increase the separation between the equipment and receiver
- Connect the equipment into an outlet on a circuit different from that to which the receiver is connected
- Consult the dealer or an experienced radio/TV technician for help

This device complies with Part 15 of the FCC Rules. Operation is subject to the following two conditions: (1) This device may not cause harmful interference, and (2) this device must accept any interference received, including interference that may cause undesired operation.

FCC Caution: Any changes or modifications not expressly approved by the party responsible for compliance could void the user's authority to operate this equipment.

Industry Canada Statements

This device complies with Industry Canada license-exempt RSS standard(s). Operation is subject to the following two conditions: (1) this device may not cause interference, and (2) this device must accept any interference, including interference that may cause undesired operation of the device.

Avis de conformité pour l'Industrie Canada

Le présent appareil est conforme aux CNR d'Industrie Canada applicables aux appareils radio exempts de licence. L'exploitation est autorisée aux deux conditions suivantes : (1) l'appareil ne doit pas produire de brouillage, et (2) l'appareil doit accepter tout brouillage radioélectrique subi, même si le brouillage est susceptible d'en compromettre le fonctionnement.

To comply with FCC and Industry Canada RF radiation exposure limits for general population, the logger must be installed to provide a separation distance of at least 20cm from all persons and must not be co-located or operating in conjunction with any other antenna or transmitter.

NCC Statement

經型式認證合格之低功率射頻電機，非經許可，公司、商號或使用者均不得擅自變更頻率、加大功率或變更原設計之特性及功能。

低功率射頻電機之使用不得影響飛航安全及干擾合法通信；經發現有干擾現象時，應立即停用，並改善至無干擾時方得繼續使用。前項合法通信，指依電信法規定作業之無線電通信。低功率射頻電機須忍受合法通信或工業、科學及醫療用電波輻射性電機設備之干擾。

Translation:**Article 12**

Without permission granted by the NCC, any company, enterprise, or user is not allowed to change frequency, enhance transmitting power or alter original characteristic as well as performance to an approved low power radio-frequency device.

Article 14

The low power radio-frequency devices shall not influence aircraft security and interfere with legal communications. If found, the user shall cease operating immediately until no interference is achieved. The said legal communications means radio communications is operated in compliance with the Telecommunications Act. The low power radio-frequency devices must be susceptible with the interference from legal communications or ISM radio wave radiated devices.