

# Digital Multimeter

GDM-8200A Series

---

## USER MANUAL

GW INSTEK PART NO. 82DM-8255A3A1



ISO-9001 CERTIFIED MANUFACTURER

**GW INSTEK**

This manual contains proprietary information, which is protected by copyrights. All rights are reserved. No part of this manual may be photocopied, reproduced or translated to another language without prior written consent of Good Will company.

The information in this manual was correct at the time of printing. However, Good Will continues to improve products and reserves the right to change specifications, equipment, and maintenance procedures at any time without notice.

**Good Will Instrument Co., Ltd.**

**No. 7-1, Jhongsing Rd., Tucheng City, Taipei County 236, Taiwan.**

# Table of Contents

<b>SAFETY INSTRUCTIONS</b> .....	<b>5</b>
Safety Symbols .....	5
Safety Guidelines .....	6
<b>GETTING STARTED</b> .....	<b>9</b>
GDM-8200A Series Lineup .....	10
GDM-8200A Series Characteristics .....	11
Front Panel Overview .....	12
Rear Panel Overview .....	17
Set Up .....	19
<b>BASIC MEASUREMENT</b> .....	<b>21</b>
Basic Measurement Overview .....	22
AC/DC/AC+DC Voltage Measurement .....	24
AC/DC/AC+DC Current Measurement .....	28
2W/4W Resistance Measurement .....	30
Diode Test .....	32
Continuity Test .....	33
Frequency/Period Measurement .....	36
Temperature Measurement .....	37
<b>ADVANCED MEASUREMENT</b> .....	<b>40</b>
Advanced Measurement Overview .....	41
dBm/dB Measurement .....	43
Max/Min Measurement .....	45
Relative Value Measurement .....	46
Hold Measurement .....	48
Compare Measurement .....	49
Math Measurement .....	52
Dual Display Measurement .....	55
<b>SYSTEM/DISPLAY CONFIGURATION</b> .....	<b>57</b>
Refresh Rate Setting .....	58
Trigger Setting .....	59

---

Digital Filter Setting .....	62
Display Setting .....	64
<b>STORE/RECALL .....</b>	<b>66</b>
Store Measurement Record .....	67
Recall Measurement Record .....	68
Save Instrument Settings .....	69
Recall Instrument Settings .....	70
<b>SCANNER (OPTIONAL) .....</b>	<b>71</b>
GDM-SC1 Scanner Specifications .....	72
Scanner Installation .....	72
Setup Scan .....	79
Run Scan .....	86
<b>DIGITAL I/O .....</b>	<b>89</b>
Digital I/O Terminal Configuration .....	90
<b>REMOTE CONTROL .....</b>	<b>94</b>
Configure Interface .....	95
Command Syntax .....	98
Command Set .....	99
<b>FAQ .....</b>	<b>108</b>
<b>APPENDIX .....</b>	<b>109</b>
Firmware Version .....	110
Fuse Replacement .....	111
Specifications .....	113
EC Declaration of Conformity .....	119
<b>INDEX .....</b>	<b>120</b>







# S SAFETY INSTRUCTIONS

This chapter contains important safety instructions that you must follow when operating the GDM-8200A series and when keeping them in storage. Read the following before any operation to insure your safety and to keep the best condition for the GDM-8200A series.



## Safety Symbols

These safety symbols may appear in this manual or on the GDM-8200A series.

	<b>WARNING</b>	Warning: Identifies conditions or practices that could result in injury or loss of life.
	<b>CAUTION</b>	Caution: Identifies conditions or practices that could result in damage to the GDM-8200A series or to other properties.
	<b>DANGER</b>	High Voltage
		Attention Refer to the Manual
		Protective Conductor Terminal
		Earth (ground) Terminal

# Safety Guidelines

---

## General Guideline



### CAUTION

- Make sure that the voltage input level does not exceed DC1000V/AC750V.
- Make sure the current input level does not exceed 10A.
- Do not place any heavy object on the GDM-8200A series.
- Avoid severe impacts or rough handling that leads to damaging the GDM-8200A series.
- Do not discharge static electricity to the GDM-8200A series.
- Use only mating connectors, not bare wires, for the terminals.
- Do not block or obstruct the cooling fan vent opening.
- Do not perform measurement at the source of low-voltage installation or at building installations (Note below).
- Do not disassemble the GDM-8200A series unless you are qualified as service personnel.

---

(Note) EN 61010-1:2001 specifies the measurement categories and their requirements as follows. The GDM-8200A series fall under category I or II.

- Measurement category IV is for measurement performed at the source of low-voltage installation.
- Measurement category III is for measurement performed in the building installation.
- Measurement category II is for measurement performed on the circuits directly connected to the low voltage installation.
- Measurement category I is for measurements performed on circuits not directly connected to Mains.

## Power Supply



### WARNING

- AC Input voltage: 100–240 V AC, 50–60Hz
  - The power supply voltage should not fluctuate more than 10%.
  - Connect the protective grounding conductor of the AC power cord to an earth ground, to avoid electrical shock.
-

<p>Fuse</p>  <p>WARNING</p>	<ul style="list-style-type: none"> <li>• Fuse type: T3.15A/ 250V</li> <li>• Make sure the correct type of fuse is installed before power up.</li> <li>• To ensure fire protection, replace the fuse only with the specified type and rating.</li> <li>• Disconnect the power cord before fuse replacement.</li> <li>• Make sure the cause of fuse blowout is fixed before fuse replacement.</li> </ul>
<p>Cleaning the GDM-8200A series</p>	<ul style="list-style-type: none"> <li>• Disconnect the power cord before cleaning.</li> <li>• Use a soft cloth dampened in a solution of mild detergent and water. Do not spray any liquid into the GDM-8200A series.</li> <li>• Do not use chemical or cleaner containing harsh material such as benzene, toluene, xylene, and acetone.</li> </ul>
<p>Operation Environment</p>	<ul style="list-style-type: none"> <li>• Location: Indoor, no direct sunlight, dust free, almost non-conductive pollution (Note below)</li> <li>• Relative Humidity: &lt; 75%</li> <li>• Altitude: &lt; 2000m</li> <li>• Temperature: 0°C to 40°C (operation), 18°C to 28°C (full accuracy)</li> </ul>
<p>(Note) EN 61010-1:2001 specifies the pollution degrees and their requirements as follows. the GDM-8200A series falls under degree 2.</p> <p>Pollution refers to “addition of foreign matter, solid, liquid, or gaseous (ionized gases), that may produce a reduction of dielectric strength or surface resistivity”.</p> <ul style="list-style-type: none"> <li>• Pollution degree 1: No pollution or only dry, non-conductive pollution occurs. The pollution has no influence.</li> <li>• Pollution degree 2: Normally only non-conductive pollution occurs. Occasionally, however, a temporary conductivity caused by condensation must be expected.</li> <li>• Pollution degree 3: Conductive pollution occurs, or dry, non-conductive pollution occurs which becomes conductive due to condensation which is expected. In such conditions, equipment is normally protected against exposure to direct sunlight, precipitation, and full wind pressure, but neither temperature nor humidity is controlled.</li> </ul>	
<p>Storage Environment</p>	<ul style="list-style-type: none"> <li>• Location: Indoor</li> <li>• Relative Humidity: &lt; 75% (0~35°C), &lt;50% (35~50°C)</li> <li>• Temperature: -10°C to 70°C</li> </ul>

## Power cord for the United Kingdom

When using the GDM-8200A series in the United Kingdom, make sure the power cord meets the following safety instructions.

---

NOTE: This lead / appliance must only be wired by competent persons



**WARNING: THIS APPLIANCE MUST BE EARTHED**

IMPORTANT: The wires in this lead are coloured in accordance with the following code:

Green/ Yellow: Earth

Blue: Neutral

Brown: Live (Phase)



As the colours of the wires in main leads may not correspond with the colours marking identified in your plug/appliance, proceed as follows:

The wire which is coloured Green & Yellow must be connected to the Earth terminal marked with the letter E or by the earth symbol  $\oplus$  or coloured Green or Green & Yellow.

The wire which is coloured Blue must be connected to the terminal which is marked with the letter N or coloured Blue or Black.

The wire which is coloured Brown must be connected to the terminal marked with the letter L or P or coloured Brown or Red.

If in doubt, consult the instructions provided with the equipment or contact the supplier.

This cable/appliance should be protected by a suitably rated and approved HBC mains fuse: refer to the rating information on the equipment and/or user instructions for details. As a guide, cable of 0.75mm<sup>2</sup> should be protected by a 3A or 5A fuse. Larger conductors would normally require 13A types, depending on the connection method used.

Any moulded mains connector that requires removal /replacement must be destroyed by removal of any fuse & fuse carrier and disposed of immediately, as a plug with bared wires is hazardous if engaged in live socket. Any re-wiring must be carried out in accordance with the information detailed on this label.



# G **ETTING STARTED**

This chapter describes the GDM-8200A series in a nutshell, including its main features, package contents, and front / rear / display panel introduction. After going through the overview, follow the Power-up sequence and Functionality check section to properly setup the GDM-8200A series.

Please note the information in this manual was correct at the time of printing. However as GWInstek continues to improve its products, changes can occur at any time without notice. Please see the GWInstek website for the latest information and content.



Characteristics	GDM-8200A Series Lineup .....	10
	GDM-8200A Series Characteristics.....	11
Panel Overview	Front Panel Overview .....	12
	Measurement keys (Upper row) .....	13
	Measurement keys (Lower row) .....	15
	Rear Panel Overview .....	17
Setup	Tilt Stand.....	19
	Power Up.....	20

# GDM-8200A Series Lineup

The GDM-8200A series consists of two models:  
GDM-8251A and GDM-8255A.

**Appearance** Both two models are identical except for the model name and the meter count of the 1<sup>st</sup> display.

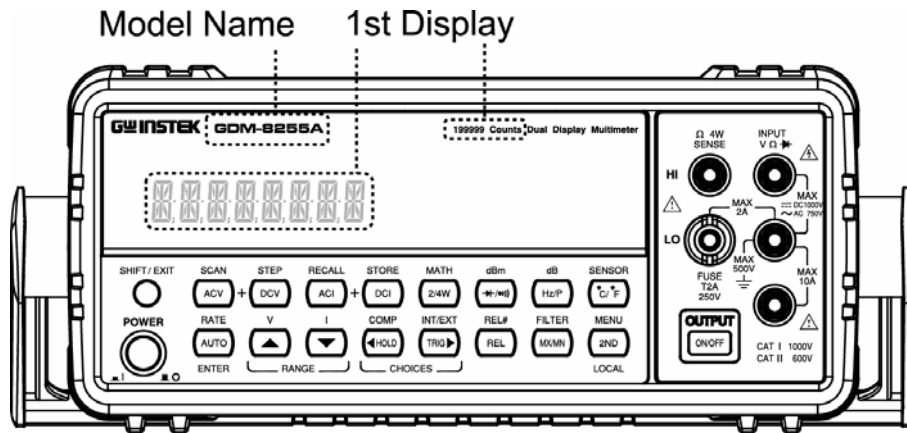

**Models**      GDM-8251A      1<sup>st</sup> display meter: 120,000 counts

**GDM-8251A**

1.200000

GDM-8255A      1<sup>st</sup> display meter: 199,999 counts

**GDM-8255A**

1.999999

## GDM-8200A Series Characteristics

The GDM-8200A series are portable, dual-display digital multimeters suitable for wide range of applications, such as production testing, research, and field verification.

---

Performance	<ul style="list-style-type: none"><li>• High DCV accuracy: 0.012%</li><li>• High current range: 10A</li><li>• High Voltage range: 1000V</li><li>• High ACV frequency response: 100kHz</li></ul>
Features	<ul style="list-style-type: none"><li>• 120000 meter count (GDM-8251A)</li><li>• 199999 meter count (GDM-8255A)</li><li>• Multi functions: ACV, DCV, ACI, DCI, 2W/4W R, Hz, Continuity, Diode test, MAX/MIN, REL, dBm, HOLD, AutoHold, Compare.</li><li>• Manual or Auto ranging</li><li>• AC true RMS or AC + DC true RMS</li></ul>
Interface	<ul style="list-style-type: none"><li>• Voltage/Resistance/Diode/Temperature input</li><li>• Current input</li><li>• 4W sense input</li><li>• USB device/RS232 for remote control</li><li>• 9-pin digital I/O</li><li>• 16 channel scanner x2 (optional)</li></ul>
Optional Items	<ul style="list-style-type: none"><li>• 16 channel scanner x 2</li></ul>

# Front Panel Overview

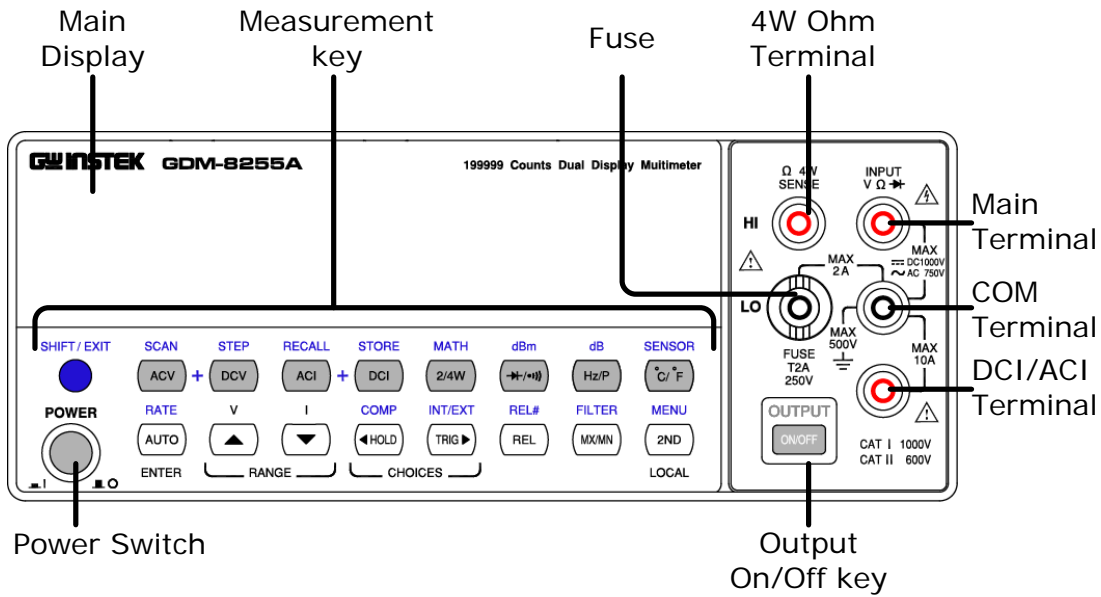

Power Switch

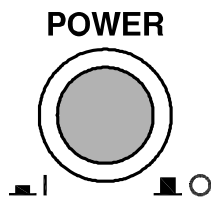

Turns On  or Off  the main power. For power up sequence, see page20.

Main Display

Shows measurement results and parameters. For display configuration details, see page64 (light setting).

Input fuse / 4W  $\Omega$  sense LO terminal

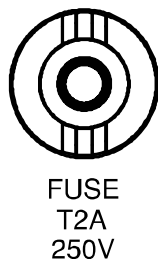

As a fuse, protects the instrument from over-current. Rating: T2A, 250V. For fuse replacement procedure, see page112. As a sense terminal, accepts 4W  $\Omega$  measurement LO connection. Also accepts current input less than 2A. For details, see page30.

4W  $\Omega$  Sense HI Terminal

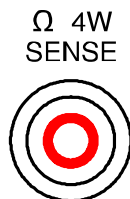

Accepts HI sense line in 4W resistance measurement. For details, see page30.

COM Terminal

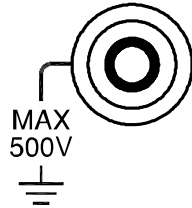

Accepts ground (COM) line in all measurements except the sense line in 4W Resistance (page30).

Voltage/ 2W  $\Omega$  /  
 (Diode)  
 Terminal

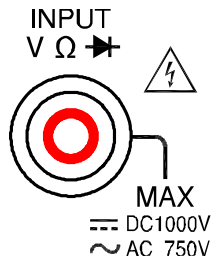

Accepts input in all measurements except for DC/AC Current and 4W Resistance sense line.

Current Terminal

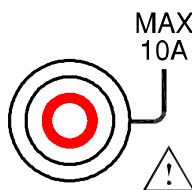

Accepts DC/AC Current input.  
 For DCI/ACI details, see page28.

Output On/Off  
 key

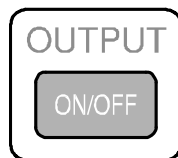

Turns the display on or off. When the display is turned off, all panel keys except the Output On/Off key become disabled. The Output On/Off key is On by default.

## Measurement keys (Upper row)

SHIFT/EXIT

SHIFT/EXIT



As the Shift key, selects the second functionality assigned to each front panel key. When pressed, the **SHIFT** indicator appears in the display.

As the Exit key, gets out of the parameter configuration mode and goes back to the measurement result display mode.

ACV



Measures AC Voltage (page24).

SHIFT  $\rightarrow$  ACV  
 (SCAN)

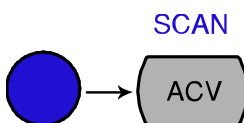





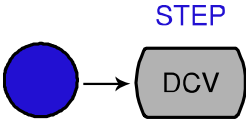
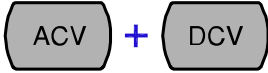
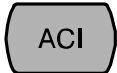
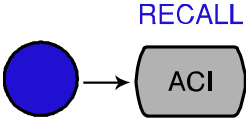

Starts the optional scan measurement (page79).

DCV

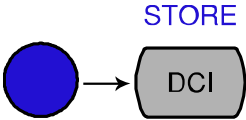
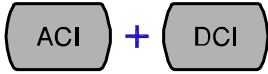
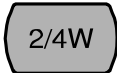
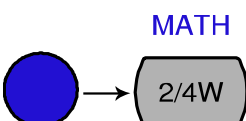
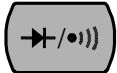
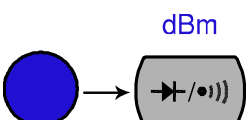

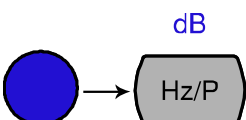

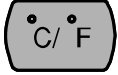



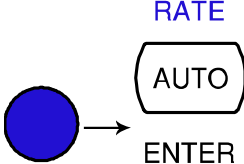

Measures DC Voltage (page24).

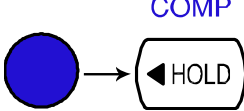
SHIFT → DCV (STEP)		STEP Starts the step measurement (page79) using the optional scanner.
ACV + DCV		When the ACV key and the DCV key are pressed together, they measure AC+DC Voltage (page24).
ACI		Measures AC Current (page28).
SHIFT → ACI (RECALL)		RECALL Recalls a normal measurement result (page68) or a scan measurement result (page87).
DCI		Measures DC Current (page28).
SHIFT → DCI (STORE)		STORE Stores a measurement result (page67).
ACI + DCI		When the ACI key and the DCI key are pressed together, they measure AC+DC Current (page28).
2/4W (Resistance)		Measures 2-wire or 4-wire Resistance (page30).
SHIFT → 2/4W (MATH)		MATH Enters the Math measurement mode (page52).
→ /• ) (Diode/ Continuity)		Tests Diode (page32) or Continuity (page33).
SHIFT → → /• ) (dBm)		dBm Measures dBm (page43).
Hz/P (Frequency/ Period)		Measures Frequency or Period (page36).
SHIFT + Hz/P (dB)		dB Measures dB (page44).

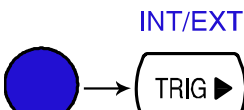
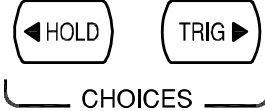
°C/°F (Temperature)		Measures Temperature (page37).
SHIFT + °C/°F (SENSOR)	<b>SENSOR</b> 	Selects the type of thermocouple used in the Temperature measurement (page38).

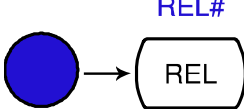
### Measurement keys (Lower row)

AUTO/ENTER	 ENTER	As the AUTO key, selects the measurement range automatically. As the ENTER key, confirms the entered value.
SHIFT → AUTO (RATE)	 ENTER	<b>RATE</b> Selects the measurement update rate: Slow, Medium, or Fast (page22).
Up/Down	 RANGE	Selects the parameter in various occasions: higher (▲) or lower (▼).
HOLD		Activates the Hold function (page48).
SHIFT → HOLD (COMPare)	 HOLD	<b>COMP</b> Activates the Compare measurement (page49).
TRIG (Trigger)		Triggers sample acquisition manually (page59).
SHIFT → TRIG (Int/Ext Trigger)	 TRIG	<b>INT/EXT</b> Selects the Internal or the External trigger source (page59).
Left/Right	 CHOICES	Selects the parameter in various occasions: left (◀) or right (▶).
REL		Measures the Relative value (page46).
SHIFT → REL (RELative base)	 REL	<b>REL#</b> Manually sets the reference value for the Relative value measurement (page46).

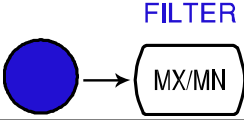
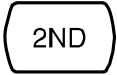
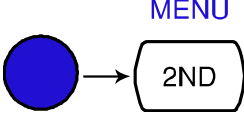
<p>MX/MN (MAX/ MIN)</p>		<p>Measures the Maximum or the Minimum value (page45).</p>
<p>SHIFT → MX/MN (FILTER)</p>		<p>Selects the digital filter type for the signal sampling (page62).</p>
<p>2<sup>ND</sup> (Display) / LOCAL</p>	 LOCAL	<p>As the 2<sup>nd</sup> key, selects the measurement item on the 2<sup>nd</sup> display (page55). Pressing and holding for more than 1 second turns off the 2<sup>nd</sup> display.</p> <p>As the Local key, releases the remote control and goes back to the local panel operation (page95).</p>
<p>SHIFT → 2<sup>ND</sup> (Menu)</p>		<p>Enters the configuration mode. Configures or displays the following items: Display (page57), Beep (page35), Continuity threshold (page34), Scanner (page79), Digital I/O (page89), and System information (page109).</p>



# Rear Panel Overview

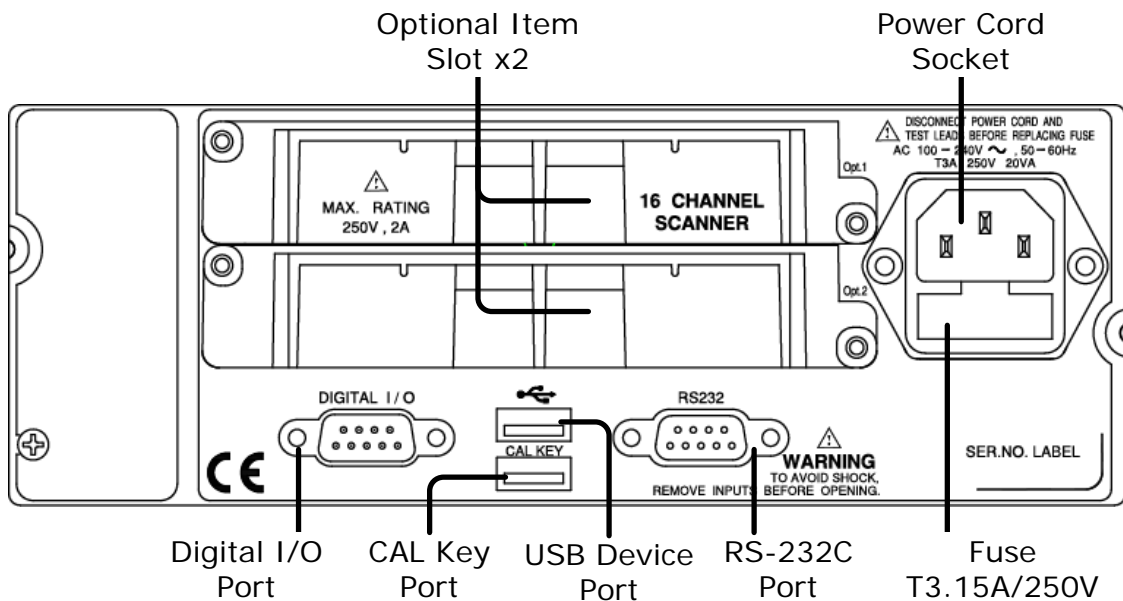

Power Cord Socket

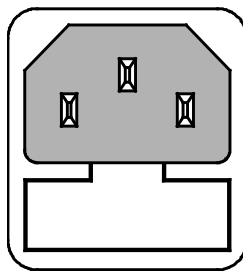

Accepts the power cord. AC 100–240V, 50–60Hz.  
For power on sequence, see page20.

Fuse Socket

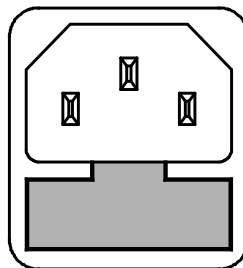

Holds the main fuse: T3.15A 250V, 20VA.  
For fuse replacement details, see page111.

RS-232C port

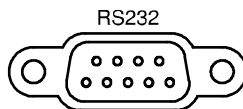

Accepts an RS-232C cable for remote control; DB-9 male connector.

For remote control details, see page96.

USB device port

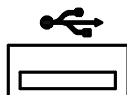

Accepts a USB device cable for remote control; Type A, female connector.

For remote control details, see page95.

CAL key port

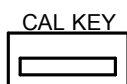

Reserved for internal uses as in firmware update and calibration.

Digital I/O port

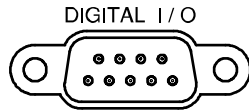

Accepts a digital I/O cable for the Hi/Lo limit test; DB-9 pin, female connector.

For digital I/O details, see page90.

Optional slot x2

Accepts up to two optional scanner modules. 16 channels are available per scanner. When two modules are used, maximum 32 channels are available.

For scanner details, see page71.

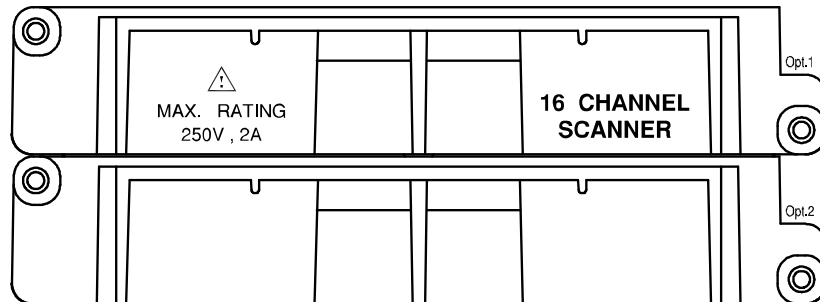

# Set Up

## Tilt Stand

Tilt stand steps

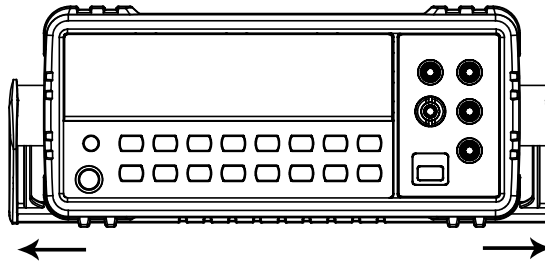

Pull out the handle sideways and rotate it.

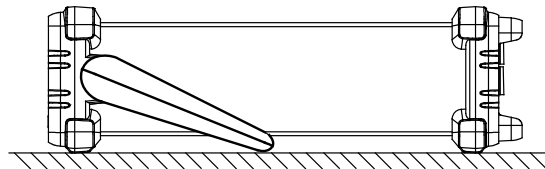

Place the unit horizontally,

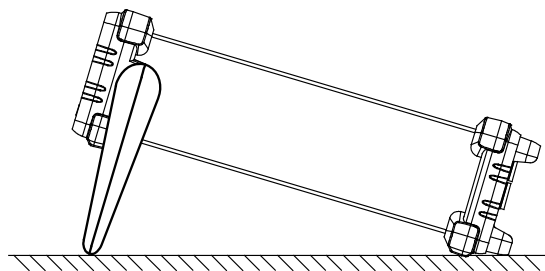

Or in the tilt stand position.

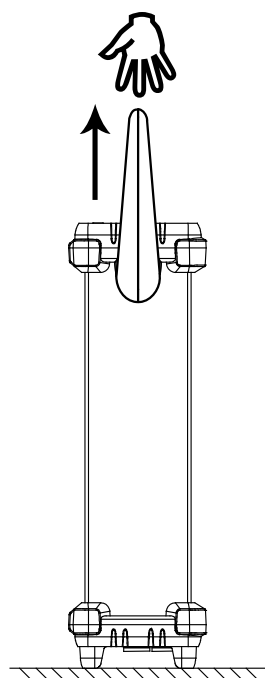

Place the handle vertically for hand carry.

## Power Up

- Power up steps
1. Connect the power cord to the AC Voltage input.

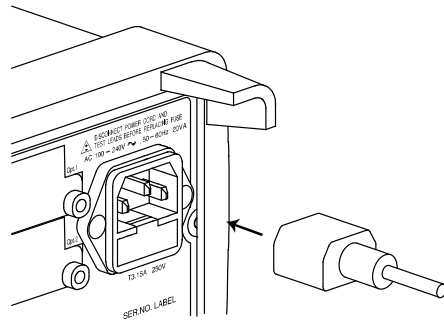

Make sure the ground connector of the power cord is connected to a safety ground. This will affect the measurement accuracy.

2. Push and turn On the main power switch on the front panel.

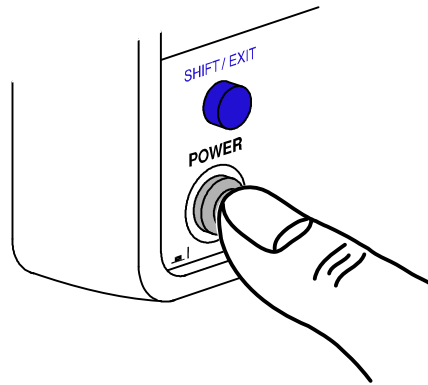

3. The display shows the model name and the version for a few seconds.  
Example: GDM-8255A, V2.00

8255A

V 2.00

4. Then the default setting appears.  
Example: DCV, Auto, 1V range

DC AUTO  
1348 16 \* V

1 V

# BASIC MEASUREMENT

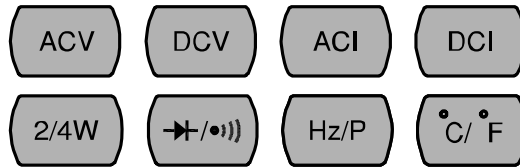

Overview	Basic Measurement Overview .....22
	Common attribute: refresh rate.....22
	Common attribute: reading indicator .....23
	Common attribute: manual/automatic triggering ..23
Voltage	AC/DC/AC+DC Voltage Measurement.....24
	Select Voltage range .....25
	Voltage conversion table .....26
	Crest factor table .....27
Current	AC/DC/AC+DC Current Measurement .....28
	Select Current range.....29
Resistance	2W/4W Resistance Measurement.....31
Diode	Diode Test .....33
Continuity	Continuity Test .....33
	Set continuity threshold .....34
	Select beeper setting.....35
Frequency/ Period	Frequency/Period Measurement .....36
Temperature	Temperature Measurement .....37
	Select thermocouple type.....38
	Set reference junction temperature .....39

# Basic Measurement Overview

Background	Basic measurement refers to the eight types of measurements assigned to the upper row keys on the front panel.	
Measurement type	ACV	AC Voltage
	DCV	DC Voltage
	ACV+DCV	AC+DC Voltage
	ACI	AC Current
	DCI	DC Current
	ACI+DCI	AC+DC Current
	2/4W	2-wire and 4-wire Resistance
		Diode/Continuity
	Hz/P	Frequency/Period
	°C/°F	Celsius/Fahrenheit Temperature

**Advanced measurement** Advanced measurement (page40) mainly refers to the operation using the result obtained from one or more of the basic measurement.

## Common attribute: refresh rate

**Background** Refresh rate defines how frequently the GDM-8200A series captures and updates the measurement data. Faster refresh rate yields lower accuracy and resolution. Slower refresh rate yields higher accuracy and resolution. Consider these trade-offs when selecting the refresh rate.

Range	S	5 1/2 digits
	M	4 1/2 digits
	F	3 1/2 digits

**Selection step** 1. Press the Shift key followed by the AUTO (RATE) key. The refresh rate switches to the next.

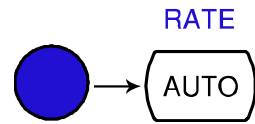

2. The refresh rate indicator shows **S→M→F→S** the current status.

### Common attribute: reading indicator

**Background** The reading indicator \* next to the 1st display flashes according to the refresh rate setting.

1.348 16 \* v

### Common attribute: manual/automatic triggering

**Automatic triggering (default)** The GDM-8200A series triggers according to the refresh rate. See the previous page for refresh rate setting details.





**Manual triggering** Press the TRIG key to trigger measurement manually.



# AC/DC/AC+DC Voltage Measurement

Voltage type	AC	0 ~ 750V
	DC	0 ~ 1000V
	AC+DC	0 ~ 1000V

$\sqrt{\quad}$  (AC = true RMS)

1. Activate ACV/DCV
- Press the ACV (AC Voltage) key or DCV (DC Voltage) key.  or 
- For AC+DC Voltage, press the ACV key and the DCV key together.  + 

2. ACV/DCV mode display appears

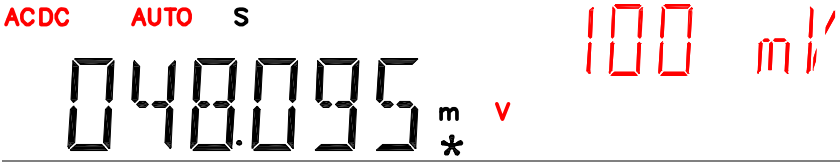



AC(DC) + V	Indicates AC, DC, AC+DC Voltage
AUTO	Indicates Automatic range selection
100mV	2nd display shows the voltage range

**\*AC+DC= AC<sup>2</sup>+**

3. Connect the test lead and measure

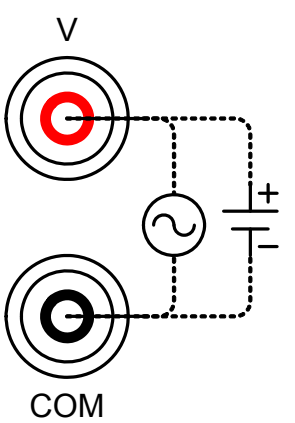
Connect the test lead between the V and the COM port. The display updates the reading.



 **Note** When measuring in 1000V (maximum) range immediately followed by 100mV (minimum) range, an error might occur due to extreme range switching. In such case, take at least one minute in between as an interval.



## Select Voltage range

**Auto range** To turn the automatic range selection On/Off, press the AUTO key. 

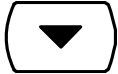



**Manual range** Press the Up or the Down key to select the range. AUTO indicator turns Off automatically. If the appropriate range is unknown, select the highest range.  

Selection list	Range	Resolution / Full scale @ slow rate		
		Resolution	Full scale (GDM-8251A)	Full scale (GDM-8255A)
	100mV	1 $\mu$ V	120.000mV	199.999mV
	1V	10 $\mu$ V	1.20000V	1.99999V
	10V	100 $\mu$ V	12.0000V	19.9999V
	100V	1mV	120.000V	199.999V
	750V (AC)	10mV	750.00V	750.00V
	1000V (DC, AC+DC)	10mV	1000.0V	1000.0V

**Note** For more detailed parameters, see the specifications at page113.

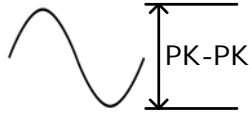
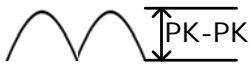
### Voltage conversion table

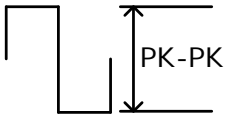
This table shows the relationship between AC, DC, and AC+DC reading in various waveforms.

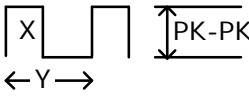
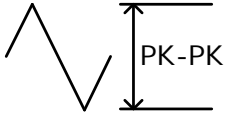





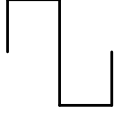

Waveform	Peak to Peak	AC (True RMS)	DC	AC + DC (True RMS)
Sine 	2.828	1.000	0.000	1.000
Rectified Sine (full wave) 	1.414	0.435	0.900	1.000
Rectified Sine (half wave) 	2.000	0.771	0.636	1.000
Square 	2.000	1.000	0.000	1.000
Rectified Square 	1.414	0.707	0.707	1.000
Rectangular Pulse 	2.000	$2K$ $K = \sqrt{(D - D^2)}$ $D = X/Y$	$2D$ $D = X/Y$	$2\sqrt{D}$ $D = X/Y$
Triangle Sawtooth 	3.464	1.000	0.000	1.000

## Crest factor table

**Background** Crest factor is the ratio of the peak signal amplitude to the RMS value of the signal. It determines the accuracy of AC measurement.

If the crest factor is less than 3.0, voltage measurement will not result in error due to dynamic range limitations at full scale.

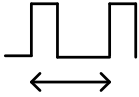



If the crest factor is more than 3.0, it usually indicates abnormal waveform as seen from the below table.

Waveform	Shape	Crest factor
Square wave		1.0
Sine wave		1.414
Triangle sawtooth		1.732
Mixed frequencies		1.414 ~ 2.0
SCR output 100% ~ 10%		1.414 ~ 3.0
White noise		3.0 ~ 4.0
AC Coupled pulse train		3.0
Spike		>9.0

# AC/DC/AC+DC Current Measurement

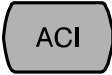
Current type	AC	0 ~ 10A
	DC	0 ~ 10A
	AC+DC	0 ~ 10A

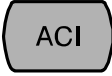
$\sqrt{\hspace{10em}}$  (AC = true RMS)

1. Activate ACV/DCV Press the ACI (AC Current) key or the DCI (DC Current) key.  or 
- For AC+DC Current, press the ACI key and the DCI key together.  + 

2. ACI/DCI mode display appears

ACDC AUTO S



10A

AC(DC) + A Indicates AC, DC, AC+DC Current (Note: AC = true RMS)

AUTO Indicates Automatic range selection

10A 2nd display shows the Current range

**\*AC+DC= AC<sup>2</sup>+**

3. Connect the test lead and measure

Connect the test lead between the A and COM port or LO to COM port, depending on the current. For current  $\leq 2A$  use the LO port; For current up to 10A use the A port. The display updates the reading.

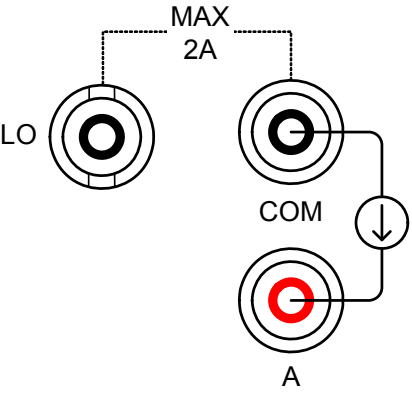

## Select Current range

**Auto range** To turn the automatic range selection On/Off, press the AUTO key. 

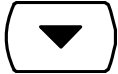
**Manual range** Press the Up or the Down key to select the range. AUTO indicator turns Off automatically. If the appropriate range is unknown, select the highest range.  

Selection list	Range	Resolution / Full scale @ slow rate		
		Resolution	Full scale (GDM-8251A)	Full scale (GDM-8255A)
	10mA	0.1μA	12.0000mA	19.9999mA
	100mA	1μA	120.000mA	199.999mA
	1A	100μA	1.2000A	1.9999A
	10A	100μA	10.0000A	10.0000A



**Note** \*10A range is not available for AC+DC Current.  
For more detailed range, see the specifications at page115.

# 2W/4W Resistance Measurement

Measurement type	2-wire	Uses the standard V-COM ports. Recommended for measuring resistances larger than 1kΩ.
	4-wire	Compensates the test lead effect using the 4W compensation ports, in addition to the standard V-COM ports. Recommended for measuring sensitive resistances smaller than 1kΩ.

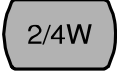
1. Activate resistance measurement

For 2-wire resistance measurement, press the 2W/4W key once. 

For 4-wire resistance measurement, press the 2W/4W key twice.  

2. 2W resistance mode display appears

**2W AUTO S** **10 M**

1.1027 **M** Ω   
 \*

---

2W(4W) + Ω Indicates 2W(4W) Resistance

---

AUTO Indicates Automatic range selection

---

10M 2nd display shows the Resistance range

3. Connect the test lead and measure

Connect the test lead. For 2-wire resistance, use the V and the COM port. For 4-wire resistance, use the V and the COM port, plus the 4W sense, and LO port for sensing. The display updates the reading.

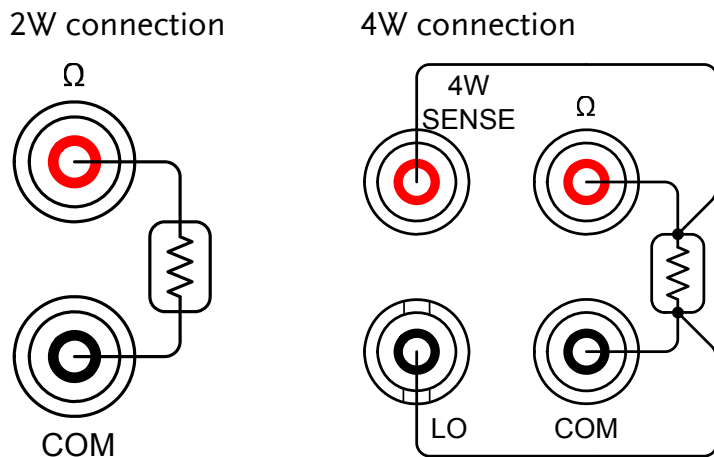



## Select Resistance range

---

**Auto range** To turn the automatic range selection On/Off, press the AUTO key. 

---

**Manual range** Press the Up or the Down key to select the range. AUTO indicator turns Off automatically. If the range is unknown, select the highest range.  

---

Selection list	Range	Full scale @ slow rate	
		GDM-8251A	GDM-8255A
	100Ω	120.000Ω	199.999Ω
	1kΩ	1.20000kΩ	1.99999kΩ
	10kΩ	12.0000kΩ	19.9999kΩ
	100kΩ	120.000kΩ	199.999kΩ
	1MΩ	1.20000MΩ	1.99999MΩ
	10MΩ	12.0000MΩ	19.9999MΩ
	100MΩ	120.000MΩ	199.999MΩ

---

**Note** For more detailed range, see the specifications at page116.

---

# Diode Test

**Background** Diode test checks the forward bias characteristics of a diode by running a constant forward bias current, approx. 0.5mA, through the DUT.

1. Activate diode test Press the  key once.



2. Diode mode display appears

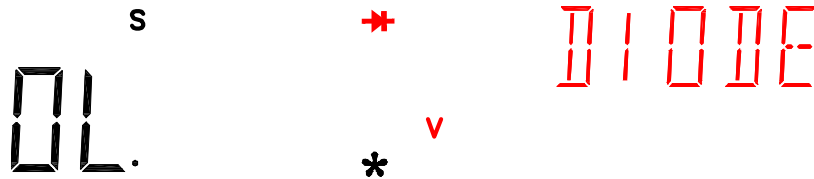

 + V Indicates Diode test

DIODE 2nd display shows the title

3. Connect the test lead and measure

Connect the test lead between the  and COM port; Anode-V, Cathode-COM. The display updates the reading.

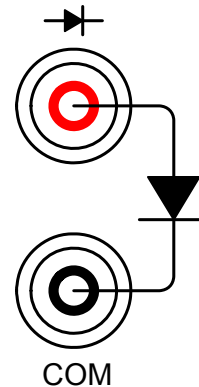



# Continuity Test

**Background** Continuity test checks that the resistance in the DUT is low enough to be considered continuous (of conductive nature).

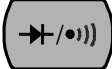
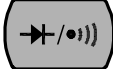
**1. Activate continuity test** Press the  key twice.  

**2. Continuity mode display appears**



The display shows 'OL' on the left and 'CONT' on the right. Above 'OL' is an 'S' symbol. To the right of 'OL' are symbols for a diode, a resistor (Ω), and an asterisk (\*).

 + Ω Indicates Continuity test

CONT 2nd display shows the title

**3. Connect the test lead and measure** Connect the test lead between the Ω and the COM port. The display updates the reading.

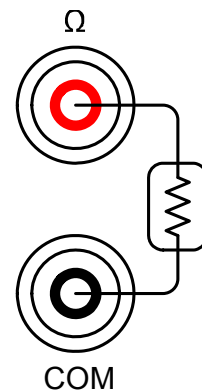

## Set continuity threshold

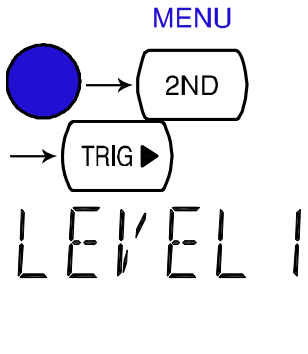
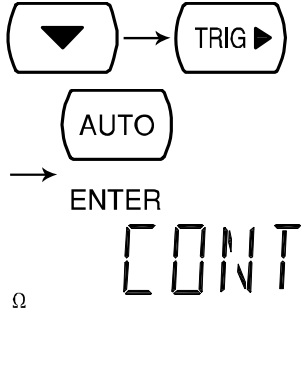
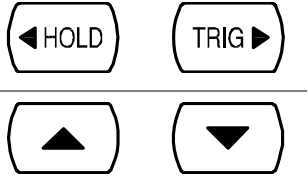
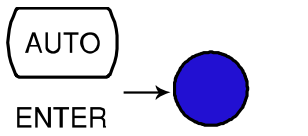
Background	Continuity threshold defines the maximum resistance allowed in the DUT when testing the continuity.	
Threshold Range	0 ~ 1000Ω, 1Ω resolution, 10Ω default	
1. Activate threshold setting	<ol style="list-style-type: none"> <li>1. Press the Shift key, the 2ND key, the Right key. The measurement menu appears.</li> </ol>	
	<ol style="list-style-type: none"> <li>2. Press the Down key, the Right key, the Enter key. The continuity threshold setting appears.</li> </ol>	
2. Edit threshold	<ol style="list-style-type: none"> <li>1. Move the cursor (the flashing digit) using the Left/Right key.</li> <li>2. Change the value using the Up/Down key.</li> </ol>	
	Range: 1 ~ 1000Ω, 1Ω resolution, default 10Ω	
3. Go back to the default display	<ol style="list-style-type: none"> <li>Press the Enter key to confirm the edited threshold. Press the Exit key to go back to the default display.</li> </ol>	

## Select beeper setting

**Background**      Beeper setting defines how the GDM-8200A series notifies the continuity test result to the user.

<b>Beeper parameter</b>	<b>Pass</b>	Beeps when the test result is pass
	<b>Fail</b>	Beeps when the test result is fail
	<b>Off</b>	Beep function is turned Off

**1. Activate beeper setting menu**

1. Press the Shift key followed by the 2nd (Menu) key. The system menu appears.

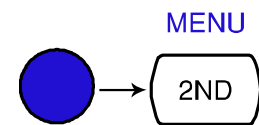

SYSTEM

LEVEL 1

2. Press the Down key. The beep menu appears.



BEEP

LEVEL 2

3. Press the Down key. The beep setting appears.



PASS

LEVEL 3

**2. Select the beep setting**

To change the setting, press the Up/Down key.



**Beeper type:** Pass (beep when pass), Fail (beep when fail, default), Off (beep off)

**3. Go back to the default display**



Press the Enter key to confirm.  
Press the Exit key to go back to the default display.

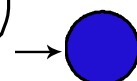

ENTER



# Frequency/Period Measurement

- |  |  |   |
|--|--|---|
| 1. Activate frequency/period measurement | To measure Frequency, press the Hz/P key once. |    |
|  | To measure Period, press the Hz/P key twice.   |   |

2. Frequency (Period) mode display appears



Hz (S)	Indicates Frequency (period) measurement
FREQ (PERIOD)	2nd display shows the title

3. Connect the test lead and measure

Connect the test lead between the V and the COM port. The display updates the reading.

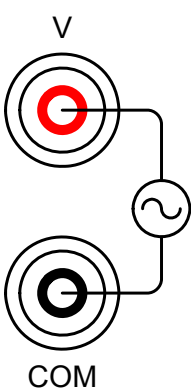



Frequency range	10Hz ~ 800kHz
Sensitivity	10Hz ~ 100kHz: >0.1V 100kHz ~ 600kHz: >1.0V 600kHz ~ 800kHz: >2.5V

Period Range	1.25µs ~ 0.1s
Sensitivity	1.25us ~ 1.666us: > 2.5V 1.666us ~ 10us: > 1.0V 10us ~ 0.1s: > 0.1V

AC Current Sensitivity	Frequency	Input level	Sensitivity level
	10Hz~10kHz	10mA/100mA	> 7mA rms
	45Hz~10kHz	1A/10A	> 3mA rms

# Temperature Measurement

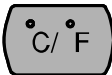
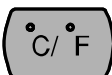
**Background** The GDM-8200A series accepts thermocouple input and calculates the temperature from the voltage fluctuation. Thermocouple type and reference junction temperature are also being considered.

**1. Activate temperature measurement** For Celsius unit, press the °C/°F key  once.  
For Fahrenheit unit, press the °C/°F   key twice.

**2. Temperature mode display appears**

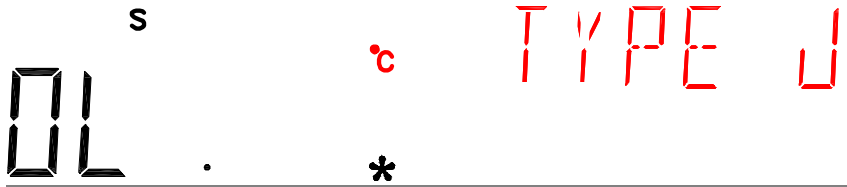

°C (°F) Indicates Temperature measurement  
TYPE J 2<sup>nd</sup> display shows the thermocouple type

**3. Connect the test lead and measure** Connect the thermocouple lead between the V and the COM port. The display updates the reading.

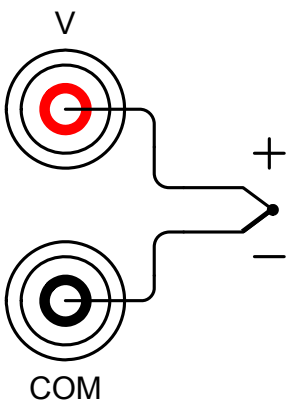

**Range** 0 ~ +300°C

## Select thermocouple type

**Background** The GDM-8200A series assumes that a certain type of thermocouple, which reads voltage fluctuation induced by temperature changes, is used to measure the temperature.

Parameter	Type	Range	Resolution
	K	0 ~ +300°C	0.01°C
	T	0 ~ +300°C	0.01°C
	J	0 ~ +300°C	0.01°C

1. Open sensor selection menu

Press the Shift key, then the °C/°F (Sensor) key. The sensor selection menu appears on the display.

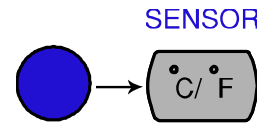

TYPE J

SENSOR

2. Select sensor type

Press the Right key to highlight the thermocouple type. Press the Up/Down key. The thermocouple type switches to the next one.

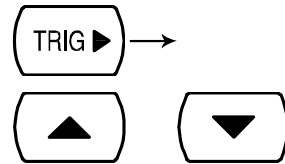

J ↔ K ↔ T

3. Confirm and go back to the default display

Press the Enter key to confirm. Press the Exit key to go back to the default display.

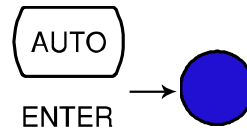

## Set reference junction temperature

**Background** When a thermocouple is connected to the GDM-8200A series, the temperature difference between the thermocouple lead and the the GDM-8200A series input terminal should be taken into account and be cancelled; otherwise an erroneous temperature might be added.

Type	Range	Resolution
SIM (simulated)	0 ~ +50°C	0.01°C

The terminal temperature is manually defined by the user.  
Default value: 23.00

**1. Open reference junction menu**

Press the Shift key, the °C/°F (Sensor) key, then the Down key. The reference junction selection menu appears on the display.

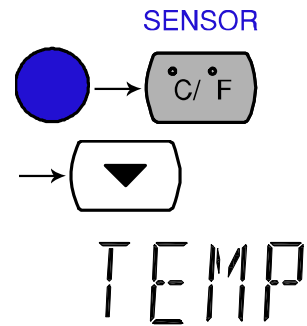

SIM

**2. Edit reference temperature**

Use the Left/Right key to move the cursor, and use the Up/Down key to change the value.

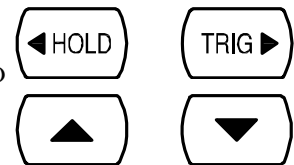

Default: 23.00

0023.00

SIM

Press the Enter key to confirm the value, or the Exit key to cancel. The display goes back to the default state.

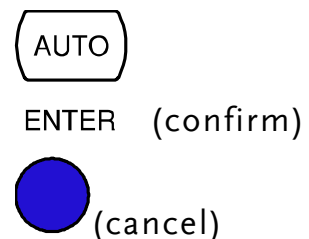

# ADVANCED MEASUREMENT

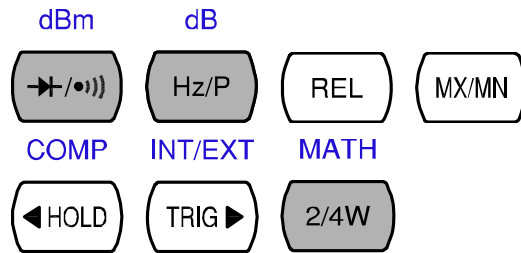

Overview	Advanced Measurement Overview .....	41
	Common attribute: refresh rate .....	41
	Common attribute: reading indicator.....	42
	Common attribute: manual/automatic triggering ..	42
<hr/>		
dBm/dB	dBm/dB Measurement.....	43
	Measure dBm.....	43
	Measure dB.....	44
<hr/>		
Max/Min	Max/Min Measurement .....	45
<hr/>		
Relative	Relative Value Measurement.....	46
<hr/>		
Hold	Hold Measurement.....	48
<hr/>		
Compare	Compare Measurement.....	49
<hr/>		
Math	Math Measurement .....	52
	Measure MX+B .....	52
	Measure 1/X .....	54
	Measure Percentage .....	54
<hr/>		
Dual Display	Dual Display Measurement.....	55



# Advanced Measurement Overview

**Background** Advanced measurement mainly refers to the type of measurement which uses the result obtained by one of the basic measurements: ACV, DCV, ACI, DCI, 2/4W, Diode/Continuity, Frequency/Period, and Temperature.

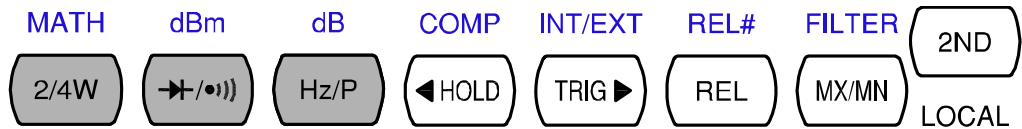

Advanced Measurement	Basic Measurement					
	AC/DCV	AC/DCI	2/4W	Hz/P	°C/°F	→+/(•))
dB	●	—	—	—	—	—
dBm	●	—	—	—	—	—
Max/Min	●	●	●	●	●	—
Relative	●	●	●	●	●	—
Hold	●	●	●	●	●	—
Compare	●	●	●	●	●	—
Math	●	●	●	●	●	—
Dual Measurement	●	●	●	●	—	—

## Common attribute: refresh rate

**Background** Refresh rate defines how frequently the GDM-8200A series captures and updates the measurement data. Faster refresh rate yields lower accuracy and resolution. Slower refresh rate yields higher accuracy and resolution. Consider these trade-offs when selecting the refresh rate.

Range	S	5 1/2 digits
	M	4 1/2 digits
	F	3 1/2 digits

**Selection step** 1. Press the Shift key followed by the AUTO (RATE) key. The refresh rate switches to the next.

2. The refresh rate indicator shows **S→M→F→S** the current status.

### Common attribute: reading indicator

**Background** The reading indicator \* next to the 1st display flashes according to the refresh rate when the captured data is updated on the display.

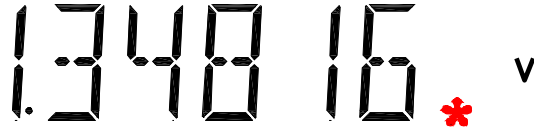

**When no data is captured** When there is no captured data, the reading indicator flashes once per two seconds (slower than the normal refresh rate), showing the GDM-8200A series is in the waiting mode.





### Common attribute: manual/automatic triggering

**Automatic triggering (default)** The GDM-8200A series triggers according to the refresh rate. See the previous page for refresh rate setting details.

**Manual triggering** Press the TRIG key to trigger measurement manually.



# dBm/dB Measurement

Applicable to   (NOT applicable to ACV+DCV)

**Background** Using the ACV or DCV measurement result, the GDM-8200A series calculates the dB or dBm value based on a reference resistance value in the following way.

$$\text{dBm} = 10 \times \log_{10} (1000 \times V_{\text{reading}}^2 / R_{\text{ref}})$$

$$\text{dB} = \text{dBm} - \text{dBm}_{\text{ref}}$$

<b>Parameters</b>	<b>Vreading</b>	Input Voltage, ACV or DCV
	<b>Vref</b>	Reference voltage obtained by Rref/1mW
	<b>Rref</b>	Reference impedance simulating an output load
	<b>dBmref</b>	Reference dBm value

## Measure dBm

**Activate dBm** Press the Shift key followed by the  key. The 1st display shows dBm, and the 2nd display shows the reference impedance.

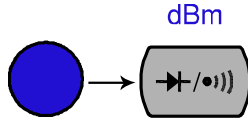

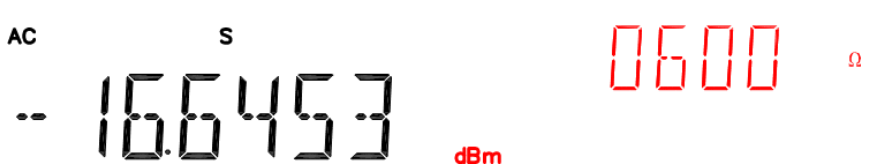

**dBm result appears**





<b>dBm</b>	Indicates dBm measurement
<b>600Ω</b>	2nd display indicates the reference impedance

**Select reference impedance** To change the reference impedance, press the Up/Down key. The new impedance appears in the 2nd display. The following is the impedance list.

 

2	4	8	16	50	75	93
110	124	125	135	150	250	300
500	600	800	900	1000	1200	8000

**Deactivate dBm measurement** To cancel the dBm measurement, press the Shift key followed by the  key, or simply activate another measurement. 

## Measure dB

**Background** dB is defined as  $[dBm - dBm_{ref}]$ . When the dB measurement is activated, the GDM-8200A series calculates the dBm using the reading at the first moment and stores it as dBmref.

**Activate dB** Press the Shift key followed by the Hz/P key. The 1st display shows dB, and the 2nd display shows the current Voltage reading. 

**dB result appears**



AC      AUTO    S  
056.448<sup>m</sup> dB      113.729<sup>m</sup> V







dB                      Indicates dB measurement

113.729mV      Indicates the present Voltage reading

**dBmref** Press the 2<sup>ND</sup> key to see the dBmref value.

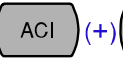

**Deactivate dB measurement** To cancel the dBm measurement, press the Shift key followed by the Hz/P key, or simply activate another measurement. 

# Max/Min Measurement

Applicable to  (+)   (+)    

**Background** Maximum and Minimum measurement stores the highest (maximum) or lowest (minimum) reading and shows it on the 2nd display.

**1. Activate Max/Min** For Max measurement, press the MX/MN  key once.

For Min measurement, press the MX/MN   key twice.

**2. Max (Min) result appears**



The image shows a digital display with two rows. The top row shows 'DC', 'AUTO', 'S', and 'MIN' in red. The main display shows '0.11573' in black with a '\*' below the '3' and a 'v' to the right. To the right of this, a second display shows '0.11516' in red with a 'v' to its right.

MIN (MAX) Indicates Min (Max) measurement

0.11516 2nd display shows the Min (Max) measurement result

**Deactivate Max/Min measurement** To cancel the Max/Min measurement, press the MX/MN  key for 2 seconds, or simply activate another measurement.

# Relative Value Measurement

Applicable to     

**Background** Relative measurement stores a value, typically the data at the moment, as the reference. The following measurement is shown as the delta between the reference.

**1. Activate Relative measurement** Press the REL key. The measurement reading at the moment becomes the reference value. 

**2. Relative measurement display appears**



- REL Indicates Relative value measurement
- 2nd display Shows the reference value
- 1st display Shows the delta between the current measurement data and the reference value

**Manually set the reference value**

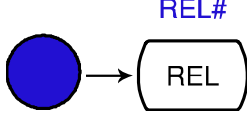
1. To set the reference value manually, press the Shift key followed by the REL key. The setting appears. 

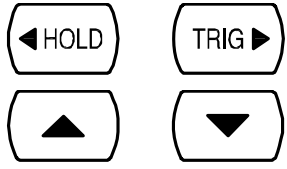

- REL Indicates Relative measurement
- 1st display Shows the reference value
- 2nd display Indicates Relative value modification

2. Use the Left/Right key to move the flashing point (cursor), and use the Up/Down key to change the value. 

- 
3. Press the Enter key to confirm the value, or the Exit key to cancel. The display switches to measurement.

A rectangular button with rounded corners containing the text "AUTO".

ENTER (confirm)



(cancel)

---

Deactivate  
Relative  
measurement

To cancel the Relative measurement, press the Shift key followed by the REL key, or simply activate another measurement.



REL#

A rectangular button with rounded corners containing the text "REL".

# Hold Measurement

Applicable to     

**Background** Hold measurement retains the current measurement data and updates it only when the reading fluctuates more than the threshold setting as the percentage of the retained data.



**1. Activate Hold measurement** Press the HOLD key. 

**2. Hold measurement display appears** 

**HOLD** Indicates Hold measurement

**2nd display** Shows the Hold threshold

**1st display** The measurement data which is updated only when it fluctuates more than the threshold compared to the retained value.

**3. Select hold threshold** Select the hold threshold using the Up/Down key. The 2<sup>nd</sup> display changes accordingly.  

**Range** 0 ~ 99%, 1% resolution

**Deactivate Hold measurement** To cancel the Hold measurement, press the Hold key for 2 seconds, or simply activate another measurement. 



# Compare Measurement

Applicable to ACV (+) DCV ACI (+) DCI 2/4W Hz/P °C/°F

**Background** Compare measurement checks and updates if the measurement data stays between the upper (high) and lower (low) limit specified.

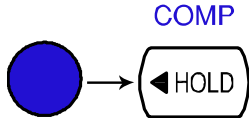
**1. Activate Compare measurement** Press the Shift key, then the HOLD (Comp) key. 

**2. High limit setting** DC AUTO S 1.000000 v HIGH

**1st display** Shows the high limit value

**2nd display** Indicates high limit setting

1. Use the Left/Right key to move the cursor (flashing point) between high/low setting, digits, and decimal point. 

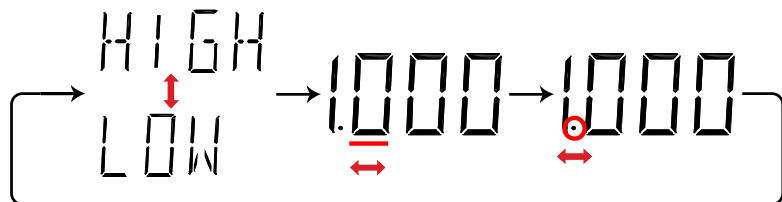

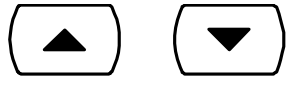
2. Change the parameter using the Up/Down key. 



3. Press the ENTER key to confirm editing and move to the low limit setting.   
ENTER

3. Low limit setting





1st display Shows the low limit value

2nd display Indicates low limit setting

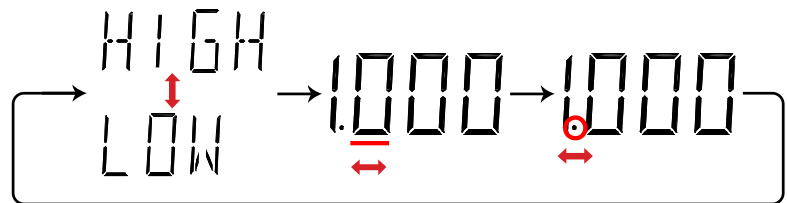
- Use the Left/Right key to move the cursor (flashing point) between high/low setting, digits, and decimal point.  



- Change the parameter using the Up/Down key.  



- Press the ENTER key to confirm editing. The compare measurement starts right away.  ENTER

4. Compare measurement appears



COMP Indicates Compare mode

2<sup>nd</sup> display Shows the compare measurement result: Pass, High, or Low.

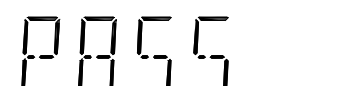
5. Result	High	If the 2 <sup>nd</sup> display shows High, the result is above the High limit.	
		Digital I/O: FAIL Out (Pin 6) and HIGH Limit FAIL Out (Pin 7) are activated.	
	Low	If the 2 <sup>nd</sup> display shows Low, the result is below the Low limit.	
		Digital I/O: FAIL Out (Pin 6) and LOW Limit FAIL Out (Pin 8) are activated.	
	Pass	If the 2 <sup>nd</sup> display shows Pass, the result is staying between the High and the Low limit.	
		Digital I/O: PASS Out (Pin 5) is activated.	

Digital I/O The Compare measurement result comes out from the rear panel Digital I/O terminal. For the terminal details, see page89.

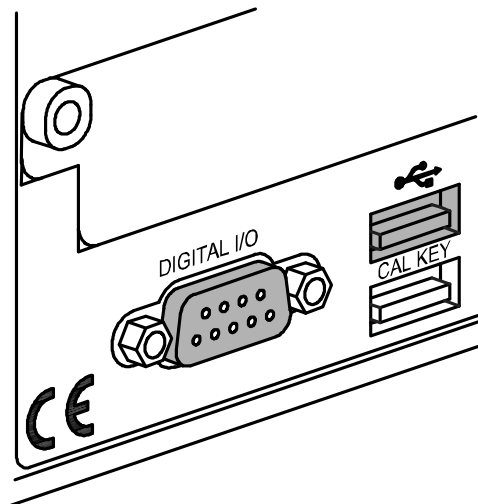

Deactivate Compare measurement

To cancel the Compare measurement, press the Shift key followed by the HOLD (Comp) key, or simply activate another measurement.

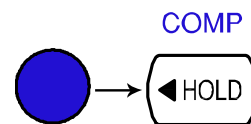

# Math Measurement

Applicable to     

**Background** Math measurement runs three types of mathematical operation, MX+B, 1/X, and percentage, based on the other measurement results.

<b>Math type</b>	<b>MX+B</b>	Multiplies the reading (X) by the factor (M) and adds/subtracts offset (B).
	<b>1/X</b>	Divides the reading (X) by 1, which provides the inverse number.
	<b>Percentage</b>	Runs the following equation. $\frac{(\text{Reading}X - \text{Reference})}{\text{Reference}} \times 100\%$

## Measure MX+B

1. **Activate MX+B** Press the Shift key followed by the 2/4W (Math) key. The MX+B setting appears.

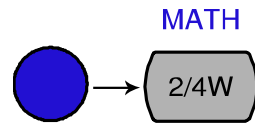

2. **Set the factor (M)**

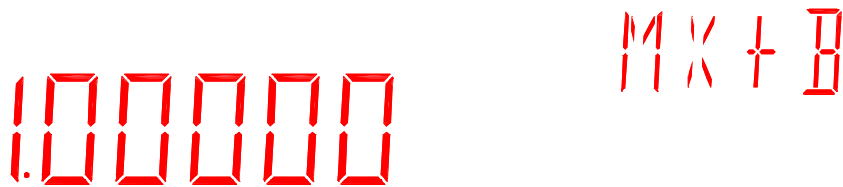



1st display Shows the factor (M)

2nd display Indicates MX+B (The letter M flashes)

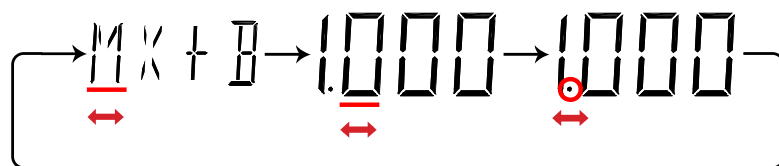
1. Use the Left/Right key to move the cursor (flashing point) between the factor, digits, and decimal point.



2. Change the parameter using the Up/Down key.  



3. Press the ENTER key to confirm editing and move to offset setting.   
ENTER

3. Set the offset (B)





1st display Shows the offset (B)

2nd display Indicates MX+B (The letter B flashes)

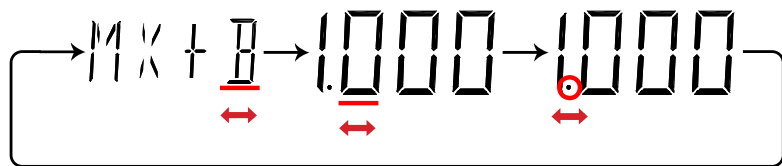
1. Use the Left/Right key to move the cursor (flashing point) between the offset, digits, and decimal point.  



2. Change the parameter using the Up/Down key.  

3. Press the ENTER key to confirm the editing. The MX+B measurement result appears.   
ENTER

4. View MX+B



1st display Shows the calculated result

2nd display Indicates MX+B

MATH Indicates Math operation

## Measure 1/X

1. Activate 1/X Press the Shift key, the 2/4W (Math) key, the Down key twice. The 1/X setting appears.

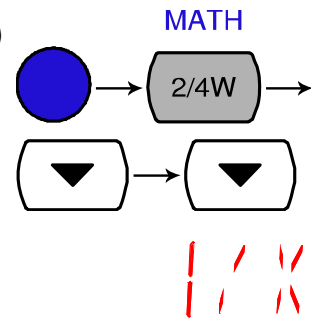

INVERSE

- Press the ENTER key to view the 1/X measurement result.



AC AUTO S 00.4669 \* V MATH 1/X

1st display Shows the 1/X value

2nd display Indicates 1/X

MATH Indicates Math operation

## Measure Percentage

1. Activate Percentage Press the Shift key, the 2/4W (Math) key, the Up key. The Reference setting appears. The Percentage is calculated as:  

$$\frac{[\text{Reading} - \text{Reference}]}{\text{Reference}} \times 100\%$$

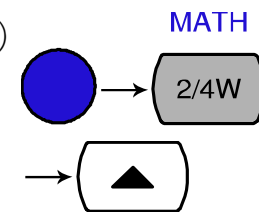



2. Set the reference number



1000000 REF %

1st display Shows the reference number

2nd display Indicates Percentage setting

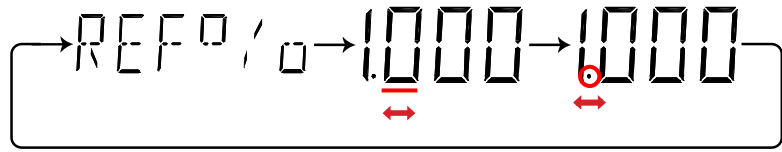
1. Use the Left/Right key to move the cursor (flashing point) between high/low setting, digits, and decimal point.  



2. Change the parameter using the Up/Down key.  

3. Press the ENTER key to confirm editing and move to offset setting.  ENTER

4. View Percentage **AC** **AUTO** **S**  **MATH**

**-.000.253** \* **V**

1st display Shows the calculated result

2nd display Indicates the Percentage measurement

MATH Indicates Math operation

## Dual Display Measurement

**Background** You can use the 2nd display to show another item, thus viewing two different measurement results at once. The following table shows the available options.

1 <sup>st</sup> Display	2 <sup>nd</sup> Display				
	ACV	DCV	ACI	DCI	Hz/P
ACV	●	●	●	●	●
DCV	●	●	●	●	●
ACV+DCV	—	—	—	—	—
ACI	●	●	●	●	●
DCI	●	●	●	●	●
ACI+DCI	—	—	—	—	—

2W* (see Note)	●	●	●	●	●
Hz/P	●	●	●	●	●
°C/°F	—	—	—	—	—
→(←/→))	—	—	—	—	—

**Note**

- In the dual display mode, the resistance needs to be larger than 1MΩ.
- Some combination of dual display mode is possible but may not be useful, and their accuracies are not guaranteed.

**2<sup>nd</sup> Measurement item setting** Press the 2nd key, then the target item (example: ACV). The display updates the measurement result. (example: ACI + ACV)

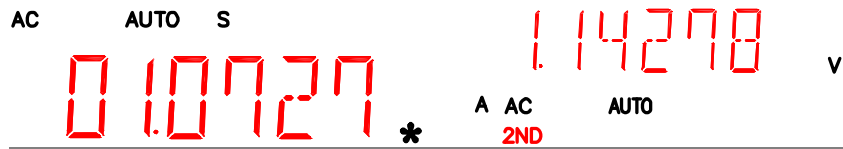
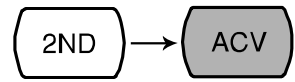

- 1<sup>st</sup> Display** Shows the primary measurement result
- 2<sup>nd</sup> Display** Shows the secondary measurement result
- 2ND** Indicates that dual measurement is active

**Turn Off 2<sup>nd</sup> Measurement** To turn Off the 2<sup>nd</sup> measurement, press and hold the 2<sup>nd</sup> key for more than 1 second.





# SYSTEM/DISPLAY CONFIGURATION



Refresh Rate	Refresh Rate Setting.....	58
Trigger	Manual/Automatic triggering.....	59
	Use external trigger.....	59
	Set trigger delay .....	60
Digital Filter	Overview .....	62
	Filter setting.....	63
Display	Display Setting.....	64
	Display on/off setting (+ key lock) .....	65

# Refresh Rate Setting

**Background** Refresh rate defines how frequently the GDM-8200A series captures and updates the measurement data. Faster refresh rate yields lower accuracy and resolution. Slower refresh rate yields higher accuracy and resolution. Consider the trade-off when selecting the refresh rate.

**Display/Range** DC **AUTO** **S** | |

0.48095 m V

---

S 5 ½ digits

---

M 4 ½ digits

---

F 3 ½ digits

**Refresh rate selection** Press the Shift key followed by the AUTO key. The refresh rate indicator switches to the next.

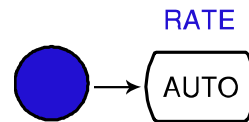

**S → M → F → S**

# Trigger Setting

## Manual/Automatic triggering

**Automatic triggering (default)** The GDM-8200A series triggers according to the refresh rate. See the previous page for refresh rate setting details.

**Manual triggering** Press the TRIG key to trigger measurement manually.



## Use external trigger

**Background** The GDM-8200A series uses the internal trigger by default, for example to count the frequency and the period. Using an external trigger allows customized triggering condition.

**Signal connection** Connect the external trigger signal to the Digital I/O port located on the rear panel.

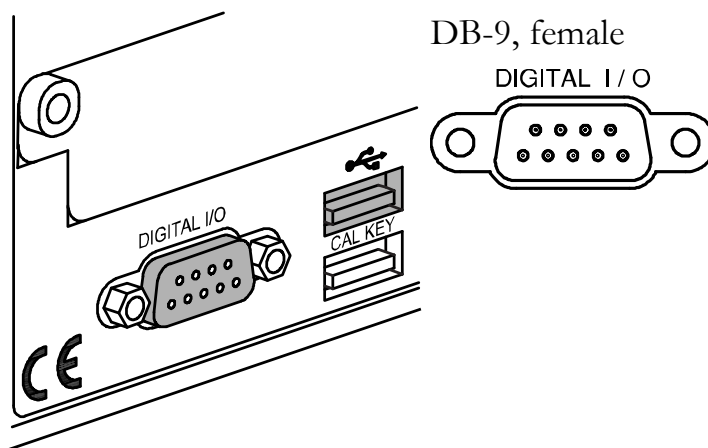

**Digital I/O pin assignment**

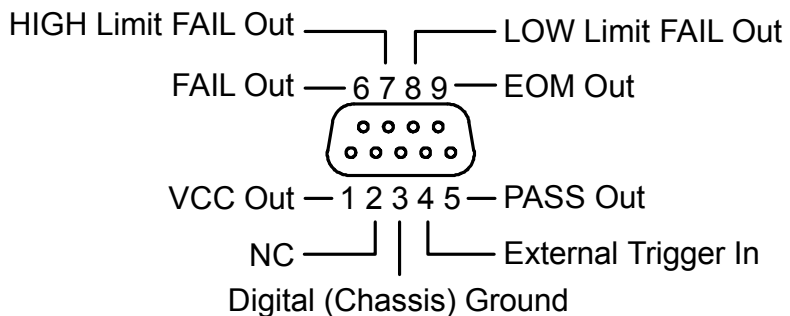

1. Activate external trigger

Press the Shift key followed by the TRIG key. The EXT indicator appears on the display.

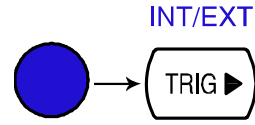

PERIOD

EXT

2. Start trigger

Press the TRIG key to start triggering manually. The \* indicator turns On.



AUTO S  
-- 00.0000 1 m \*

Reading indicator

The reading indicator \* stays On before triggering. After triggering, the indicator flashes according to the external signal trigger timing.

Exit external trigger

Press the Shift key followed by the TRIG key. The EXT indicator disappears and the trigger goes back to internal mode.

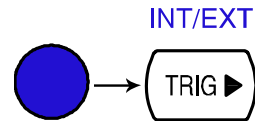

## Set trigger delay

Background

Trigger delay defines the time rag between triggering and measurement start. The default is set at 10ms.

Panel operation

1. Press the Shift key, the 2ND (Menu) key, the Right key, the Down key. The delay menu appears.

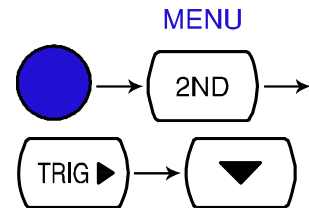

DELAY

LEVEL2

2. Press the Down key. The delay setting appears.



00 10.m5

DELAY

3. Move the flashing point (cursor) using the Left/Right key. Change the value using the Up/Down key.

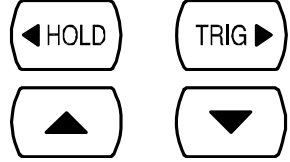

4. Press the ENTER key to confirm editing and press the EXIT key. The display goes back to previous mode.

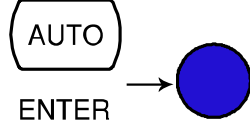

Range

1 ~ 1000ms, 1ms resolution

# Digital Filter Setting

## Overview

---

**Filter basic** The GDM-8200A series internal digital filter converts the analog input signal into digital format before passing it to internal circuits for processing. The filter affects the amount of noise included in the measurement result.

---

**Filter type** The digital filter averages a specific number of input signal samples to generate one reading. The filter type defines the averaging method. The following diagrams show the filter difference as an example of averaging 4 samples per reading.

---

**Moving (default)** Moving filter takes in one new sample and discards the oldest sample per reading. This is the default behavior when the digital filter is not specified, and is recommended for most applications except for the optional scanner operation (page71).

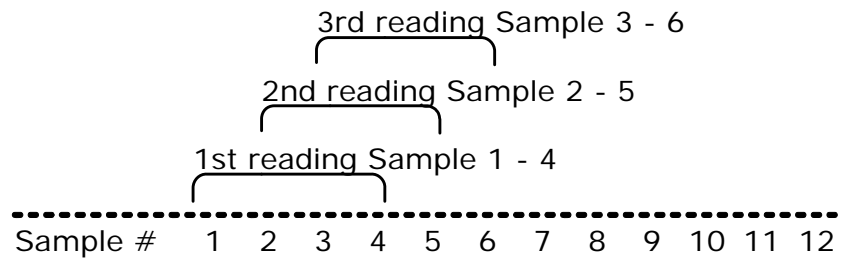

**Repeating** Repeating filter renews the whole samples per reading. This method is recommended when using the optional scanner (page71).

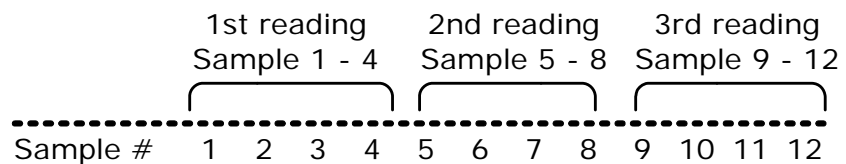

**Filter count** Filter count defines the number of samples to be averaged per reading. More samples offer low noise but long delay. Less samples offer high noise but short delay.

**Range** 2 ~ 100

---

## Filter setting

Step

1. Press the Shift key followed by the MX/MN (Filter) key.

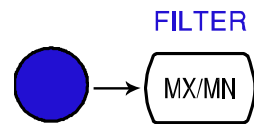

AC      AUTO    S

CNT: 0 10      MOV

1st display Shows the filter count

2nd display Shows the filter type (flashing)

2. Select the filter type using the Up/Down key.

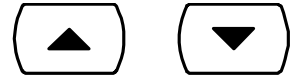

MOV → REP → MOV

3. Move the cursor to filter count using the Left/Right key. Change the value using the Up/Down key.

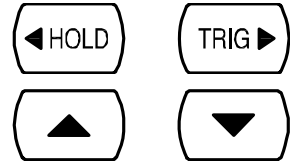

CNT: 0 10

↔

4. Press the ENTER key to confirm editing. The Filter indicator appears on the display.



ENTER

DC      AUTO

1348 16. \* v      I I

FILT

FILT Indicates manual Filter setting

# Display Setting







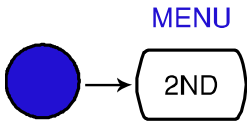

## Display light setting

---

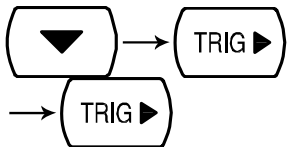
**Background** Display light setting adjusts the brightness of the display reading. Use level 3 or more (brighter) when working indoor; use level 2 or 1 (darker) when working outdoor under the sun.

**Level** 5 (brightest) ~ 1 (darkest), default Level 3

---

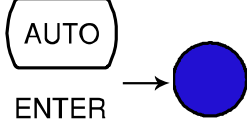
- |                        |  |   |
|------------------------|--|---|
| <b>Panel operation</b> | <p>1. Press the Shift key followed by the 2ND (Menu) key. The system menu appears.</p>                         |    |
|                        |                              |    |
|                        | <p>2. Press the Down key, then the Right key twice. The light menu appears.</p>                                |  |
|                        |                             |  |
|                        | <p>3. Press the Down key. The light level setting appears.</p>   |  |
|                        |                             |  |
|                        | <b>1st display</b> Shows the current display light level   |   |
|                        | <p>4. Select the level using the Up/Down key.</p>  |  |
|                        | <p>5. Press the Enter key to confirm your selection. Press the Exit key to go back to the default display.</p> |  |
-



## Display on/off setting (+ key lock)

---

**Background**      The display can be turned off when not used for a long time. Note that when this function is used, the panel keys are also locked except for the Output On/Off key. The display is turned on by default.

---

**Panel operation**      1. Press the Output On/Off key once. The display will be turned off and the panel keys become locked.

---

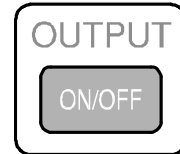

2. To enable the display and panel keys, press the Output On/Off key again.

# STORE/RECALL

For storing and recalling measurement results using the Scanner, see page 71.

STORE    RECALL



---

Store Measurement Record .....	67
Recall Measurement Record .....	68
Save Instrument Settings.....	69
Recall Instrument Settings.....	70

---

# Store Measurement Record

**Background** The GDM-8200A series can store the measurement history which can be recalled later for observation and analysis as in Maximum, Minimum, and Average value.

Data count 1 ~ 9999

**Not applicable to** Store/recall measurement history is not applicable to Diode/Continuity test  $\rightarrow$ ( $\bullet$ )).

**Store step**

1. Press the Shift key followed by the DCI (Store) key. The store menu appears.

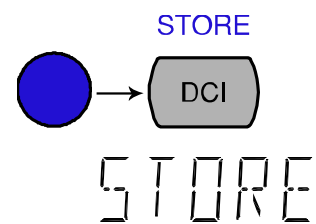

CNT:00 16

2. Move the cursor using the Left/Right key. Change the data count using the Up/Down key.

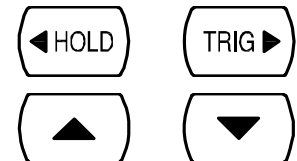

3. Press the Enter key to confirm editing and to go back to the previous display.



DC AUTO S  
0.48095 m v

STO

STO Indicates the measurement history is stored

# Recall Measurement Record

**Background** The GDM-8200A series can recall the stored measurement history for observation and analysis as in Maximum, Minimum, and Average value.

**Not applicable to** Store/recall measurement history is not applicable to Diode/Continuity test (→/•)).

**Recall stored record** Press the Shift key, then the ACI (Recall) key. The stored measurement record appears.

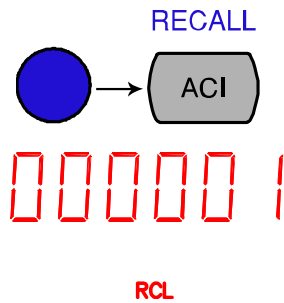

AC

116.543 m V

000001

RCL

1st display Shows the stored measurement result

2nd display Shows the reading count

RCL Indicates the data has been recalled

**View each reading** Change the reading count using the Up/Down key.

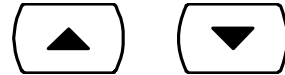

**View Max/Min/Average** Switch to the Average/Maximum/Minimum value of the recorded data using the Right key.



000:00 1 → AVG → MAX → MIN

# Save Instrument Settings

**Background** The GDM-8200A series can save up to ten instrument settings. The settings can save the state, function, I/O and range. Upon powering up, the current instrument setting is displayed.

**Set Instrument Setting** Press the Shift key, the 2ND key, Down and then Left twice. The Save menu appears.

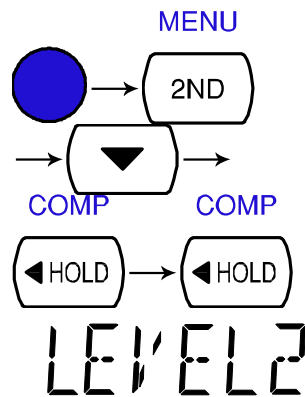

SAVE

Press the Down key to enter the Save menu.



**Memory Slot Selection** Choose the memory slot to save to by using the Up, Down, Left and Right keys.

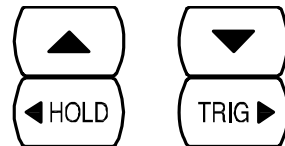

**Confirm Selection** Press Enter to confirm the save slot.



ENTER

Press the Shift key to return to the measurement screen.



The current instrument settings have been saved. To enable the settings at power up, follow the instructions in the next section.

# Recall Instrument Settings

**Background** The Recall function to enables saved settings to be recalled power up.

**Set Instrument Setting** Press the Shift key, then the 2ND (Menu) key, Down and Left once. The Recall menu appears.

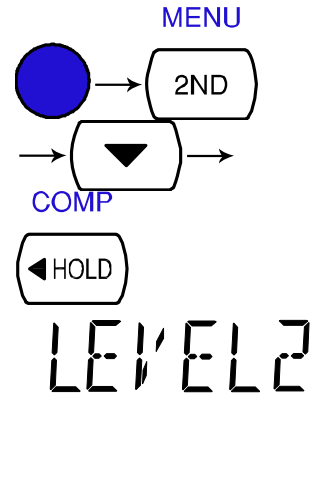

Press the Down key to enter the Recall menu.



**Memory Slot Selection** Choose the memory slot to recall from by using the Up, Down, Left and Right keys.

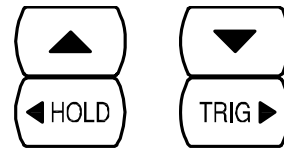

**Confirm Selection** Press Enter to confirm the memory slot.



ENTER

Press the Shift key to return to the measurement screen



When the instrument is reset or upon the next power up, the recalled settings will be enabled.

# S **SCANNER (OPTIONAL)**

The optional scanner GDM-SC1 lets you effectively measure multiple channels connected to a single the GDM-8200A series.

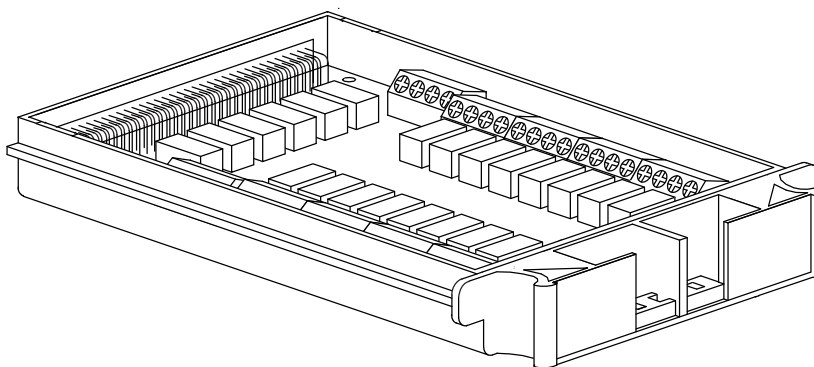
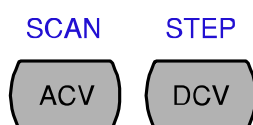

Installation	GDM-SC1 Scanner Specifications .....	72
	Configure scanner .....	72
	Select Channel group and enable scanner.....	74
	Connect wire .....	75
	Insert scanner .....	76
	Scanner Configuration Record.....	78
Setup	Overview .....	79
	Setup Simple Scan .....	80
	Setup Advanced Scan .....	82
	Use external trigger.....	84
Run	Overview .....	86
	Run Scan/Step .....	86
	Recall Scan/Step result .....	87
	Setup and run monitoring.....	87

# GDM-SC1 Scanner Specifications

2-wire channel	16 pairs	Maximum current	2A (ch17, ch18)
4-wire channel	8 pairs	Resistance	2/4 wire
Single wire channel	N/A	Cold junction	N/A (internal)
Maximum voltage	250V	Connection	Screw terminal

## Scanner Installation

### Configure scanner

- Open Scanner cover
1. Take off four screws from the bottom panel of the scanner.

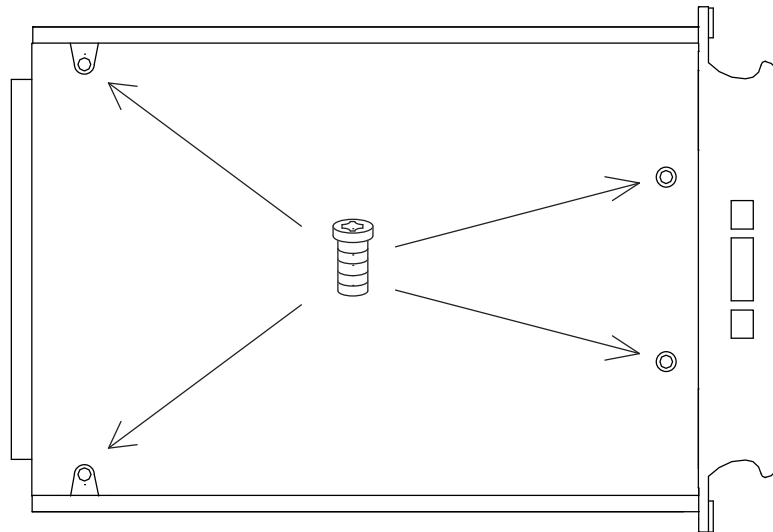

2. Remove the top panel.

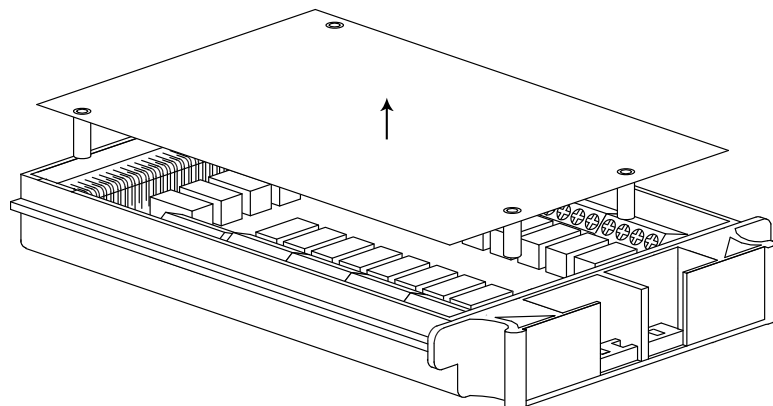



3. The connection terminals appear.

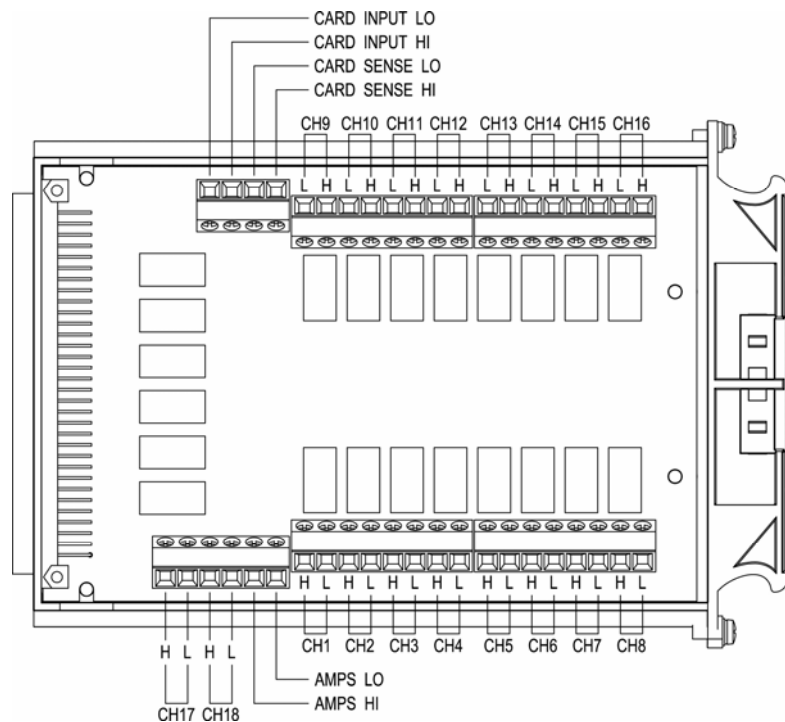

**Overview** 16 general purpose channels are available, 8 on the left row, 8 on the right row. Current (ACI, DCI) measurement uses 2 extra channels. All channels are fully isolated (Hi and Lo).

**Scan/Step connection** Refer to the below table for measurement and test line connection.

Item	No. of wire	No. of channels
DCV, ACV	2 wires (H, L)	16 (CH1 ~ 16)
DCI, ACI	2 wires (H, L)	2 (CH17, 18)
2W Resistance	2 wires (H, L)	16 (CH1 ~ 16)
4W Resistance	4 wires (Input H, L + Sense H, L)	8 pairs (CH1 [input]& 9[sense], 2&10,...,8&16)
Diode/Continuity	2 wires (H, L)	16 (CH1 ~ 16)
Period/Frequency	2 wires (H, L)	16 (CH1 ~ 16)
Temperature	2 wires (H, L)	16 (CH1 ~ 16)

## Select Channel group and enable scanner

Background	2 groups, 16 channels each, are available for the scanner.
Group1	CH101 ~ 118
Group2	CH201 ~ 218

**Select group (Jumper J8)** Set the jumper J8 in the center of the board accordingly. Move the jumper to the right (pins 2-3) for selecting CH1xx (101 ~ 118), and move to the left (pins 1-2) for selecting CH2xx (201 ~ 218).

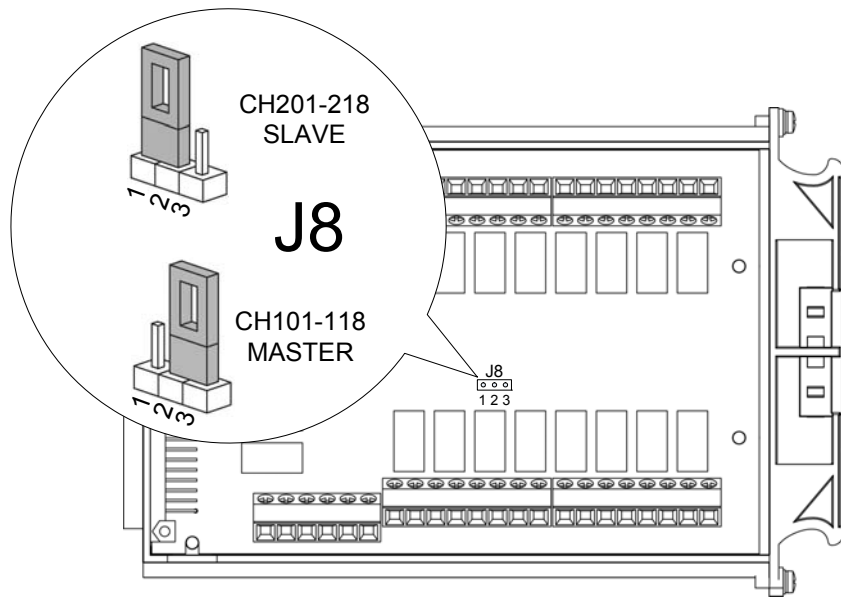

**Enable scanner (Jumper J9)** Set the jumper J9 on the rear side of the board accordingly. Move the jumper up (pins 3-2) to disable the scanner, and down (pins 2-1) to enable the scanner.

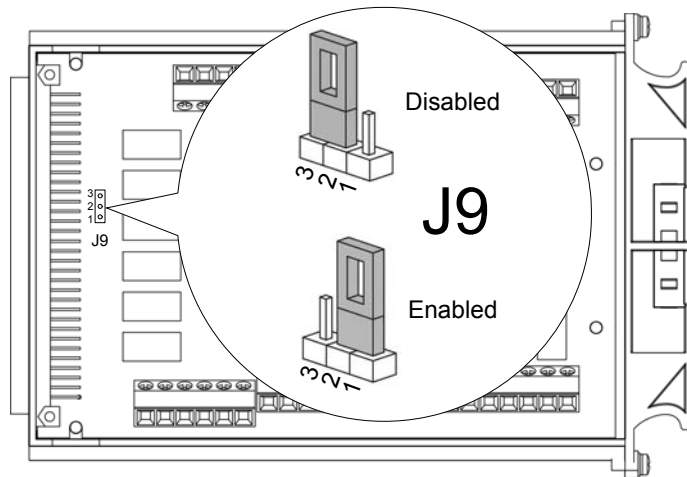

## Connect wire

---

**Wire selection** Make sure the wires have at least the same Voltage and Current capacity as the maximum ratings in the measurement.

---

**Connection** 1. Turn the screw left (loose) using the screw driver and insert the wire. Turn the screw right (tight) and secure the connection.

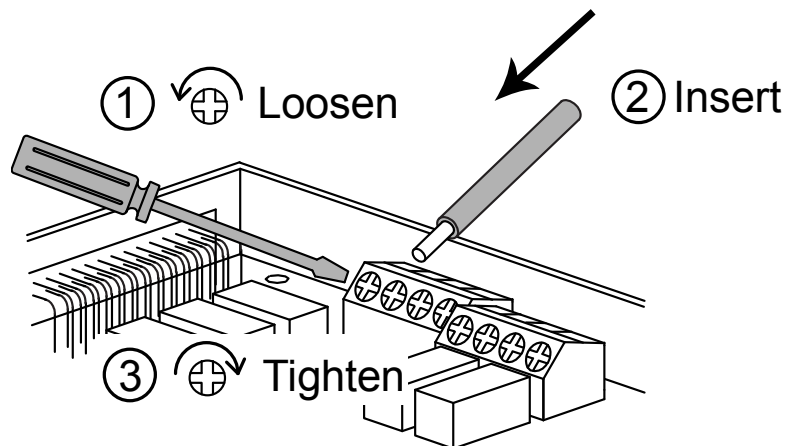

2. Route the wires as follows, using the two openings (left and right) at the front cover.

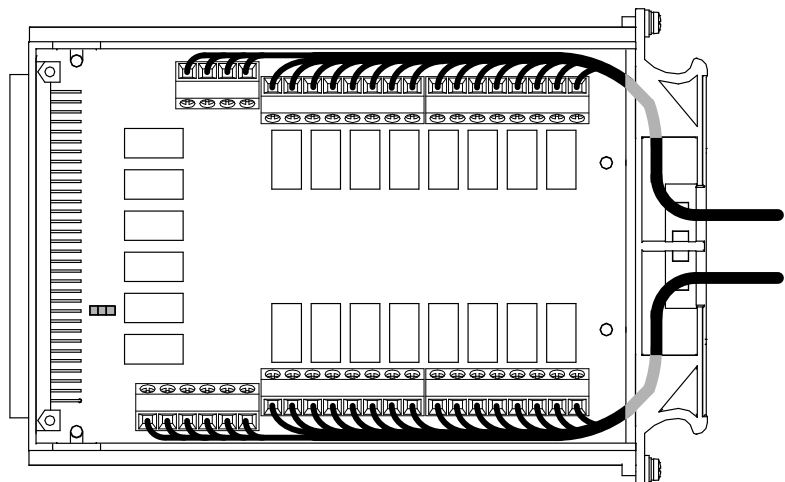

3. Bundle the wires at the front cover using the holes at the bottom.

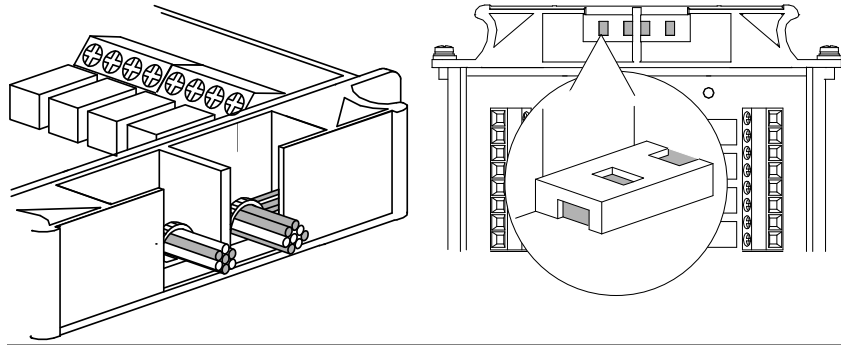

4. Close the top cover and tighten the screw from the bottom.

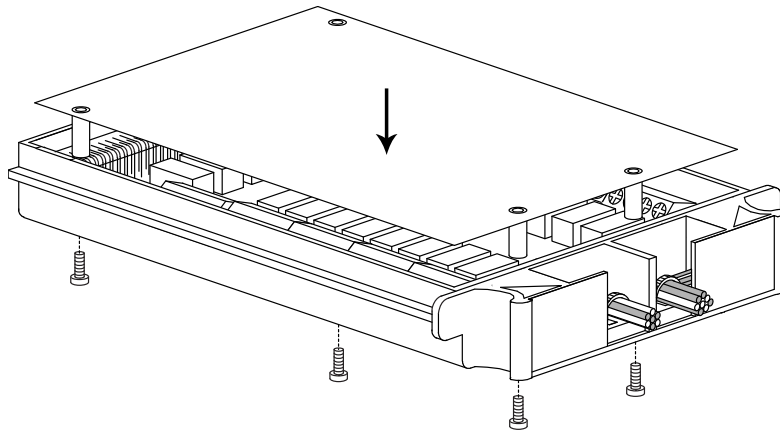

**Configuration Record**

Print out the configuration record list on page 78, fill in the details, and keep it with the GDM-8200A series.

**Insert scanner**

**Power Off**

Turn the Power Off and take off the power cord.

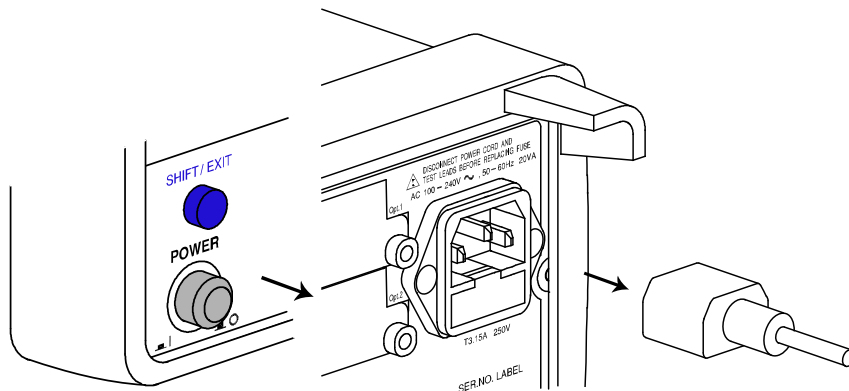

Open the GDM-8200A series rear panel slot

Take off the two screws on the slot corners to remove the optional slot cover. Keep the screws for later reuse.

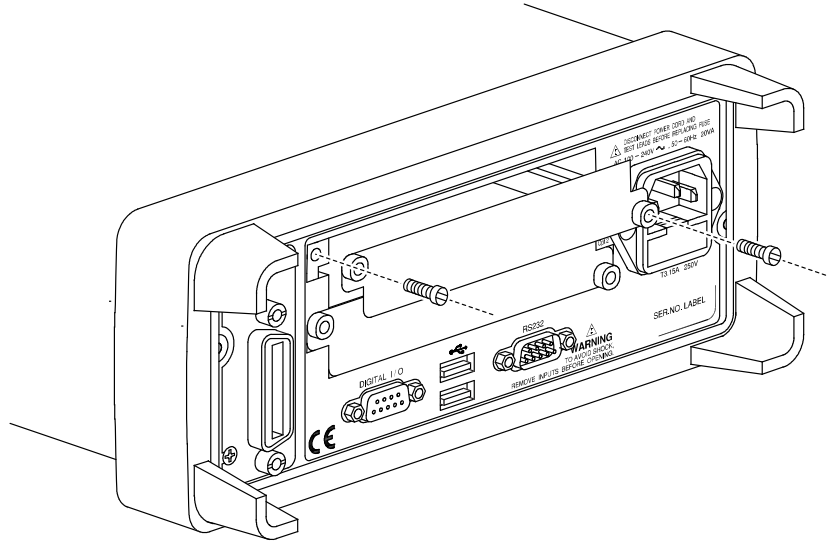

Insert the scanner

Insert the scanner (already configured according to the procedures on page 72) to either of the two slots, upper or lower. Close the cover by tightening the screws.

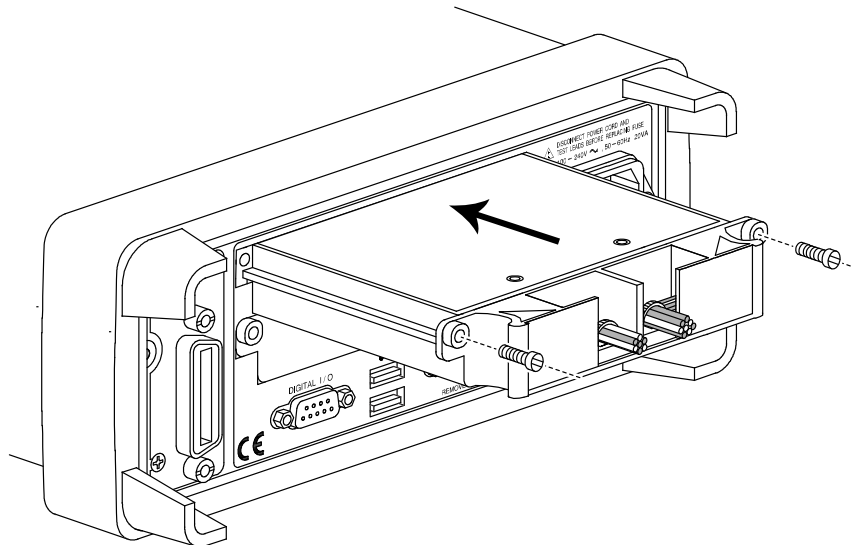

Power On

Connect the power cord and turn On the power.

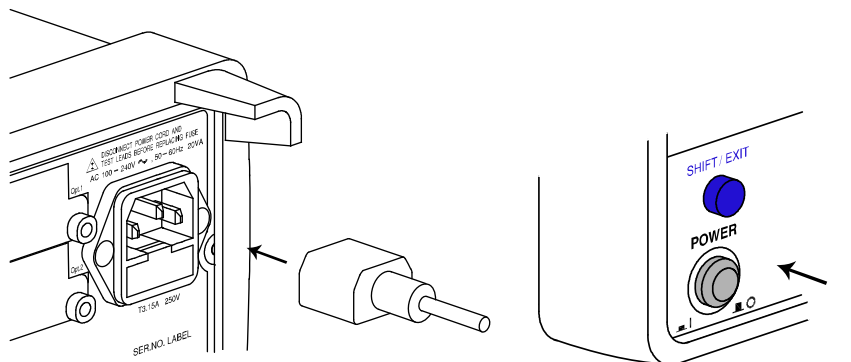

### Scanner Configuration Record

Channel	Wire color		Measure type	Note
CH1	H	L		
CH2	H	L		
CH3	H	L		
CH4	H	L		
CH5	H	L		
CH6	H	L		
CH7	H	L		
CH8	H	L		
CH9	H	L		
CH10	H	L		
CH11	H	L		
CH12	H	L		
CH13	H	L		
CH14	H	L		
CH15	H	L		
CH16	H	L		
CH17	H	L		
CH18	H	L		
CARD INPUT	H	L		
CARD SENSE	H	L		
AMPS	H	L		

# Setup Scan

## Overview

---

Scan type	Simple	Sets the scanned channel range, loop count, and timer length. All channels have a common measurement item.
	Advanced	In addition to the above Simple Scan setting, allows custom setting for each channel, such as measurement item, range, and rate.
Timer setting	Sets the duration between each scan loop (Scan operation) or between each scanned channel (Step operation).	
Count setting	Sets the number of scan operation (loop).	
Trigger setting	Internal (Continuous)	The GDM-8200A series keeps triggering continuously until the scan reach the end of loop count. Then it goes into the idle mode.
	External (Manual)	The GDM-8200A series stays in the idle mode by default. The trigger timing is manually controlled by the user from the front panel (TRIG key).
Scan operation	Scan	Measures all specified channel range at each trigger event. Timer setting (page80) applies between each scan (the whole channel range).
	Step	Measures a single channel in the specified range at each trigger event. Timer setting (page80) applies between each channel.
	Monitor	Selects just one channel and continuously measure it.

## Setup Simple Scan

Panel operation

1. Press the Shift key, the 2<sup>ND</sup> key (MENU), the Left key. The Scan menu appears.

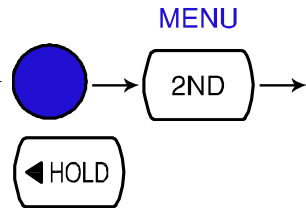

SCAN

LEVEL 1

2. Press the Down key. The Simple Scan menu appears.



SIMPLE

LEVEL 2

3. Press the Down key again. The Starting (Minimum) channel setting appears.



CHAN: 101

MIN CH

4. Move the cursor to the channel using the Left/Right key, and change the value using the Up/Down key.

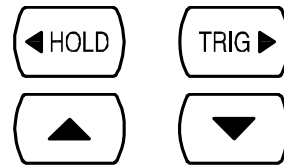

Range 101 ~ 118, 201 ~ 218

5. When finished, press the ENTER key. The End (Maximum) channel setting appears.



ENTER

CHAN: 116

MAX CH



6. Move the cursor to the channel using the Left/Right key, and change the value using the Up/Down key.

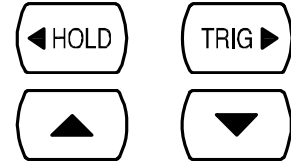

Range 101 ~ 118, 201 ~ 218 (must be the same or bigger than the Start (Min) channel)

7. When finished, press the ENTER key. The Timer setting appears.



ENTER

00 10m5

TIMER

8. Move the cursor to the channel using the Left/Right key, and change the value using the Up/Down key.

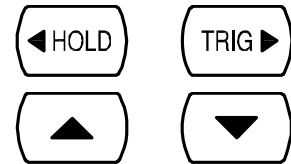

Range 1ms ~ 9999ms

9. Press the ENTER key. The loop (step) Count setting appears.



ENTER

0 16

COUNT

10. Move the cursor to the channel using the Left/Right key, and change the value using the Up/Down key.

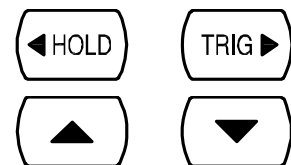

Range 1 ~ 999

11. Press the ENTER key followed by the EXIT key. The setting is stored and the display goes back to the normal mode.



ENTER

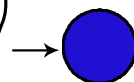

## Setup Advanced Scan

Panel operation

1. Press the Shift key, the 2<sup>ND</sup> key (MENU), the Left key. The Scan menu appears.

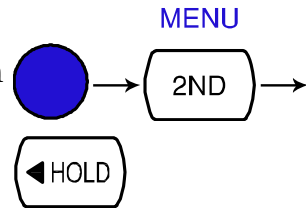

SCAN

LEVEL 1

2. Press the Down key followed by the Right key. The Advanced Scan menu appears.

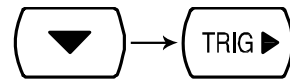

ADV'AN

LEVEL 2

3. Press the Down key. The Starting (Minimum) channel setting appears.



CHAN: 101

MIN CH

4. Move the cursor to the channel using the Left/Right key, and change the value using the Up/Down key.

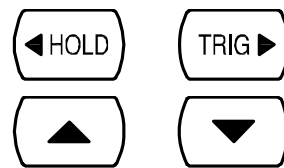

Range 101 ~ 118, 201 ~ 218

5. When finished, press the ENTER key. The End (Maximum) channel setting appears.



ENTER

CHAN: 116

MAX CH

6. Move the cursor to the channel using the Left/Right key, and change the value using the Up/Down key.

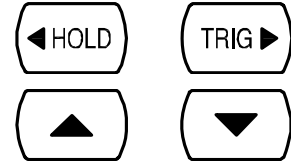

Range 101 ~ 118, 201 ~ 218 (must be the same or bigger than the Start (Min) channel)

7. When finished, press the ENTER key. The Timer setting appears.



00 10m5

TIMER

8. Move the cursor to the channel using the Left/Right key, and change the value using the Up/Down key.

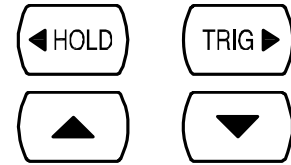

Range 1ms ~ 9999ms

9. When finished, press the ENTER key. The Count setting appears.



0 16

COUNT

Range 1 ~ 999

10. Move the cursor to the channel using the Left/Right key, and change the value using the Up/Down key.

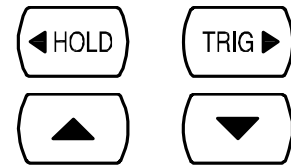

11. When finished, press the ENTER key. The channel setting appears.



12. The Minimum (first) scanned channel, as set in the Simple Scan setting, appears. The default setting is CH101.





13. Set the measurement condition.

- To select measurement item, press the target key. 

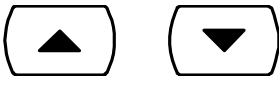
- To select Auto range, press the AUTO key. 

- To manually select the range, press the Up/Down key. 

14. When finished, press the Right key to confirm edit and to move to the next channel. 

15. When all channel configurations are completed, press the EXIT key. The display goes back to the default mode. 

## Use external trigger

**Background** The GDM-8200A series uses the internal trigger by default. Using an external trigger allows customized triggering.

**Signal connection** Connect the external trigger signal to the Digital I/O port located on the rear panel.

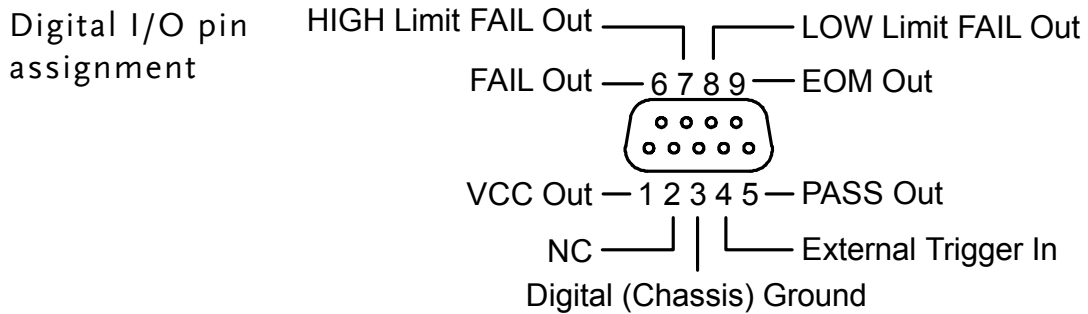
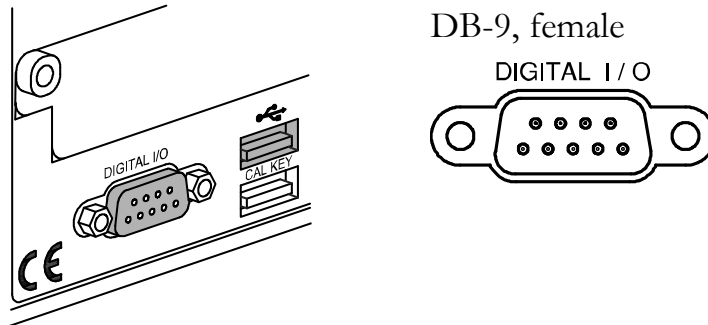

Pin4 External Trigger Input pin

**Activate external trigger** Press the Shift key followed by the TRIG key. The EXT indicator appears on the display.

**Start trigger** Press the TRIG key to start triggering manually. The reading indicator (✱) turns On.

**Reading indicator** The reading indicator ✱ stays On before triggering. After triggering, the indicator flashes according to the external signal trigger timing.

**Exit external trigger** Press the Shift key followed by the TRIG key. The EXT indicator disappears and the trigger goes back to the internal mode.

# Run Scan

## Overview

Scan operation type	Scan	Measures all specified channel range at each trigger event. Timer setting (page80) applies between each scan.
	Step	Measures a single channel in the specified range at each trigger event. Timer setting (page80) applies between each channel.
	Monitor	Continuously measure one channel.

## Run Scan/Step

Activate Scan/Step

1. Press the Shift key followed by the ACV key (SCAN) or DCV key (Step).

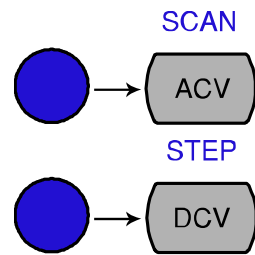

2. The STO indicator turns On. The Scan (Step) starts running and the data is recorded. After running the predefined count, the Scan (Step) stops running.



Abort Scan/Step

To abort Scan/Step or to go back to the normal display, press the Shift key followed by the ACV key (Scan) or DCV key (Step) again.

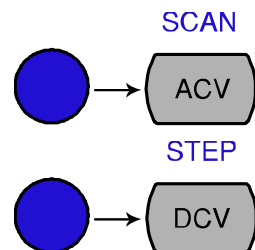

Reactivate Scan/Step

To run the Scan (Step) again, press the TRIG key. The previous data is overwritten by the new Scan.



## Recall Scan/Step result

Panel operation

1. After the Scan/Step is completed, the data is stored internally. Press the Shift key followed by the ACI (Recall) key.

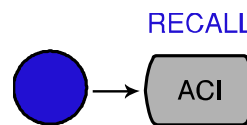

2. The first channel appears. (example: channel 101)

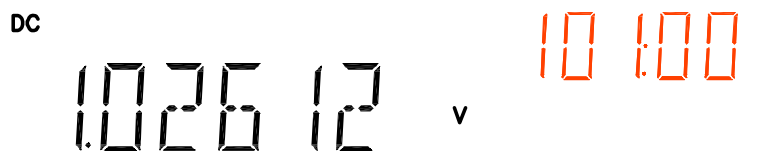

3. To view the Max/Min/Average data, press the Left key.



4. To move to the next channel, press the Up/Down key.



5. Press the EXIT key to get out from recall mode.



## Setup and run monitoring

Panel operation

1. Press the Shift key, the 2<sup>ND</sup> key (MENU), the Left key. The Scan menu appears.

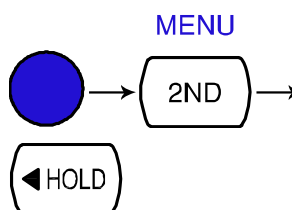

2. Press the Down key followed by the Left key. The Monitor Scan setting menu appears.

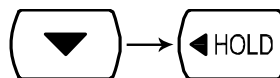

3. Press the Down key. The channel selection appears.



CHAN: 10 1

MONIT 0

4. Move the cursor to the channel using the Left/Right key, and change the value using the Up/Down key.



5. When finished, press the ENTER key. The Monitoring starts.



ENTER

DC AUTO S

0.48095 m v

CH 10 1



# DIGITAL I/O

The rear panel Digital I/O terminal outputs the result of Compare measurement to external devices.

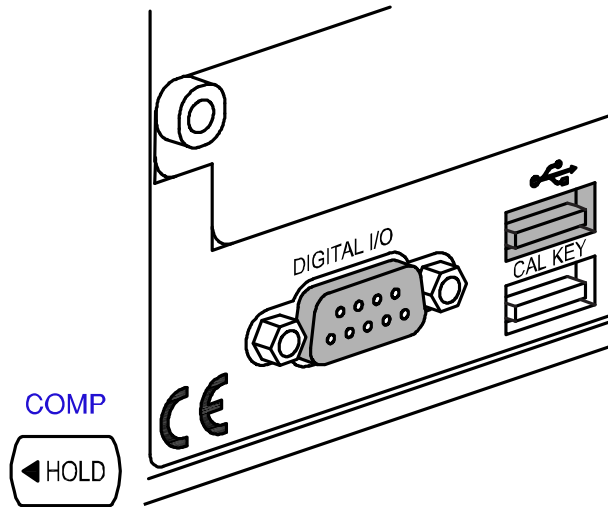

---

Terminal configuration	Digital I/O Terminal Configuration .....	90
Application	Application: Compare measurement .....	91
	Application: External trigger .....	93

---

# Digital I/O Terminal Configuration

**Background** The digital I/O terminal outputs the result of Compare measurement to control external devices. By providing separate VCC for the terminal, the outputs can also be used as power source for TTL and CMOS logics.

**Pin assignment** Connector type: DB-9 female

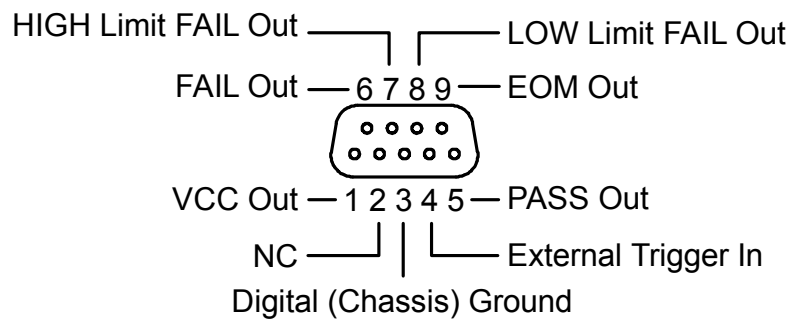
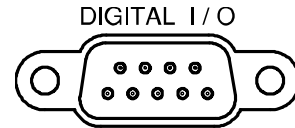

Pin1	VCC output, 5V. Serves as the power source for the external device/logic.
Pin2	NC (No Connection).
Pin3	COM (ground).
Pin4	External Trigger Input. Accepts external trigger signal. For using external signals, see page85 (Scanner) or page59 (Configuration).
Pin5	PASS signal Output. Activates when the compare result is PASS.
Pin6	FAIL signal Output. Activates when the compare result is FAIL.
Pin7	HIGH Limit FAIL signal Output. Activates when the compare result is FAIL due to violating the HIGH Limit.
Pin8	LOW Limit FAIL signal Output. Activates when the compare result is FAIL due to violating the LOW Limit.
Pin9	EOM (End Of Measurement) signal Output. Activates when compare measurement is over.

**Application: Compare measurement**

Applicable to 

**Background** Compare measurement checks and updates if the measurement data stays between the upper (high) and lower (low) limit specified.

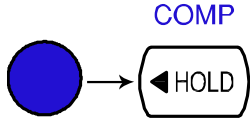
**1. Activate Compare measurement** Press the Shift key, then the HOLD (Comp) key. 

**2. High limit setting**



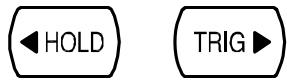

**1st display** Shows the high limit value

**2nd display** Indicates high limit setting

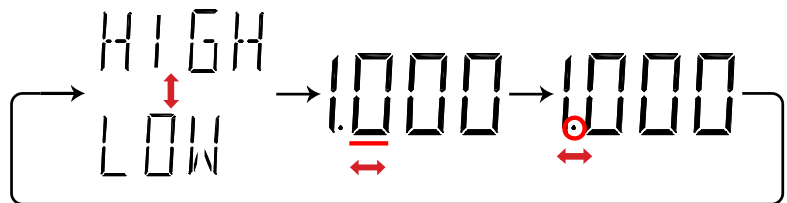
1. Use the Left/Right key to move the cursor (flashing point) between high/low setting, digits, and decimal point. 

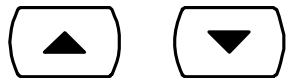

2. Change the parameter using the Up/Down key. 

3. Press the ENTER key to confirm editing and move to the low limit setting. 

**3. Low limit setting**



**1st display** Shows the low limit value

**2nd display** Indicates low limit setting

Set the low limit in the same way as in the high limit. Press the ENTER key to confirm editing. The compare measurement starts right away.



ENTER

4. Compare measurement appears



COMP Indicates Compare mode

2<sup>nd</sup> display Shows the compare measurement result: Pass, High, or Low.

5. Result

High If the 2<sup>nd</sup> display shows High, the result is above the High limit. **HIGH**

Digital I/O: FAIL Out (Pin 6) and HIGH Limit FAIL Out (Pin 7) are activated.

Low If the 2<sup>nd</sup> display shows Low, the result is below the Low limit. **LOW**

Digital I/O: FAIL Out (Pin 6) and LOW Limit FAIL Out (Pin 8) are activated.

Pass If the 2<sup>nd</sup> display shows Pass, the result is staying between the High and the Low limit. **PASS**

Digital I/O: PASS Out (Pin 5) is activated.

Deactivate Compare measurement

To cancel the Compare measurement, press the Shift key followed by the HOLD (Comp) key, or simply activate another measurement.

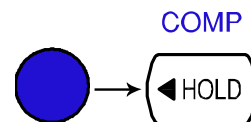

## Application: External trigger

**Background** The GDM-8200A series uses the internal trigger by default, for example to count the frequency and the period. Using an external trigger allows customized triggering condition.

**Signal connection** Connect the external trigger signal to the Digital I/O port located on the rear panel.

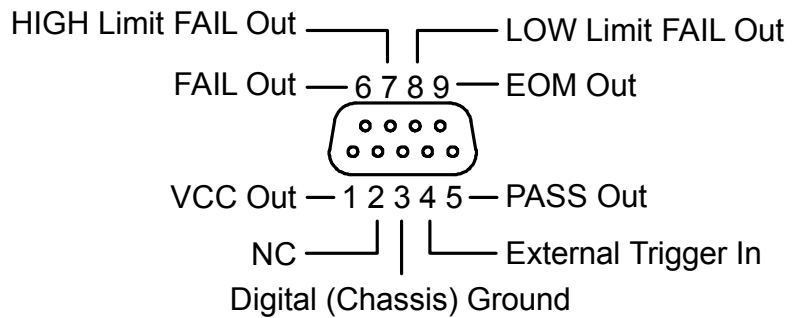

Pin4 External Trigger Input pin

1. Activate external trigger

Press the Shift key followed by the TRIG key. The EXT indicator appears on the display.

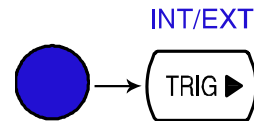

PERIOD

EXT

2. Start trigger

Press the TRIG key to start triggering manually. The \* indicator turns On.



AUTO S  
-- 00.0000 1 m \*

**Reading indicator** The reading indicator \* stays On before triggering. After triggering, the indicator flashes according to the external signal trigger timing.

**Exit external trigger**

Press the Shift key followed by the TRIG key. The EXT indicator disappears and the trigger goes back to internal mode.

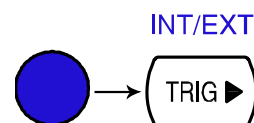

# REMOTE CONTROL

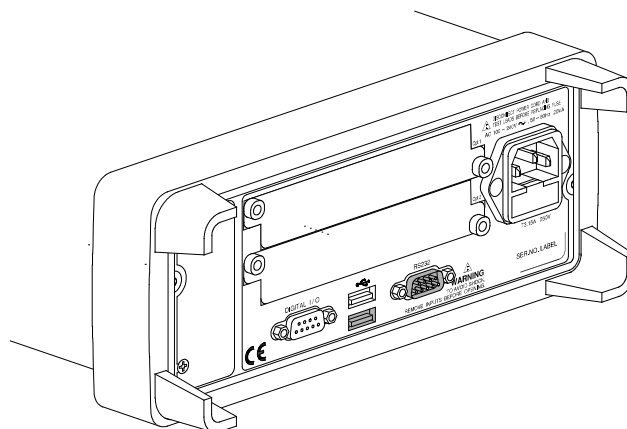



---

Interface	Overview .....	95
	Configure USB interface .....	95
	Configure RS-232C interface .....	96
<hr/>		
Command Syntax	Command Syntax .....	98
<hr/>		
Command Set	CONFigure command .....	99
	SENSe command .....	100
	UNIT command .....	101
	TRIGger command .....	103
	SYStem related command .....	104
	STAtus reporting command .....	104
	RS-232C interface command .....	104
	IEEE 488.2 common command .....	104
	ROUTe command .....	105
	CONFigure2 command .....	106

---

# Configure Interface

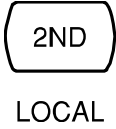
## Overview

Interface type	USB Device	USB 1.1 or 2.0, TypeA, female connector.
	RS-232C	D-sub 9 pin, male connector. Baud rate: 115200/57600/38400/19200/9600.
Return to Local control mode	In order to switch back to the Local control mode (front panel operation), press the LOCAL key.	

## Configure USB interface

USB device port configuration

1. Press the Shift key, the 2ND (Menu) key, the Right key twice. The I/O configuration menu appears.

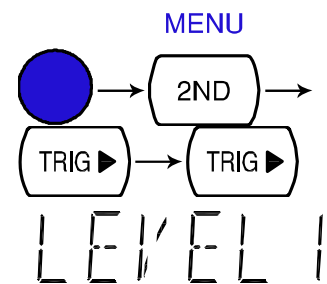

1 1 0

2. Press the Down key. The USB selection display appears.



LEVEL 2

U S B

3. Press the Down key. The USB ON/OFF selection appears.



ON

U S B

4. Press the Up/Down key to select ON or OFF.



5. Press the ENTER key to confirm USB selection.



ENTER

6. Connect the USB cable to the rear panel terminal (upper port).



## Configure RS-232C interface

### Configuration step

1. Press the Shift key, the 2ND (Menu) key, the Right key twice. The I/O configuration menu appears.

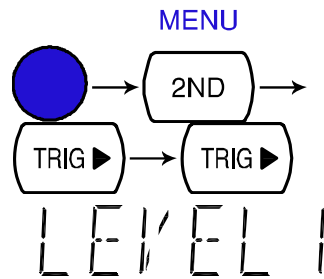

2. Press the Down key, then the Right key. The RS-232C selection display appears.

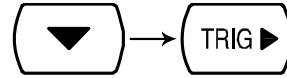

3. Press Enter or Down to confirm RS232 selection.

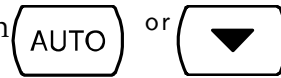

ENTER

4. Press the Down or UP keys repeatedly to select the baud rate.

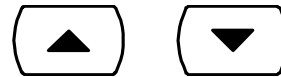

115200 ⇔ 57600 ⇔ 38400 ⇔ 19200 ⇔ 9600

5. Press the ENTER key to confirm RS-232C and baud rate selection.



ENTER

6. Connect the RS-232C cable to the rear panel terminal.

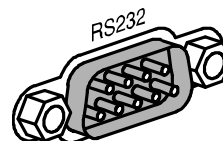



RS-232C pin assignment

Pin 2: RxD  
 Pin 3: TxD  
 Pin 5: GND  
 Pin 1, 4, 6 ~ 9: No Connection

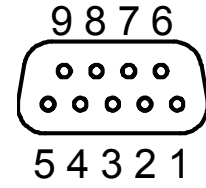

PC – GDM  
 RS-232C  
 Connection

Null-modem connection, in which transmit (TxD) and receive (RxD) lines are cross-linked, is required.

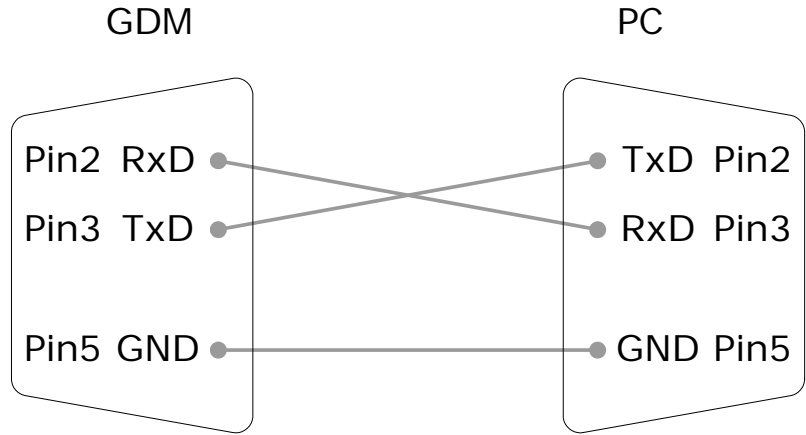

# Command Syntax

The commands are partially compatible with IEEE488.2 (1992) and SCPI (1994) standard. Commands are NON-case sensitive.

Example command		1: Command Header <hr/> 2: Single space <hr/> 3: Parameter
-----------------	--	--

Parameter example	Boolean <hr/> NR1 <hr/> NR2 <hr/> NR3 <hr/> min, max	Boolean logic: 0 or 1. Used for On (1) or Off (0) command. <hr/> Integer: 0, 1, 2, 3..... <hr/> Decimal number: 0.0, 0.1, 0.2,... <hr/> Floating point number: 4.5e-1, 8.5e+1,... <hr/> The GDM-8200A series automatically translates to Minimum (min) or Maximum (max) value available.
-------------------	--	--

Automatic parameter range selection	The GDM-8200A series automatically translates the command parameter into the closest available value.	
	Example 1	conf:volt:dc_1 (Sets the measurement item to DC Voltage and the range to 1V). the GDM-8200A series selects the 1V range.
	Example 2	conf:volt:dc_2 (Sets the measurement item to DC Voltage and the range to 2V). There is no 2V range so the GDM-8200A series selects the closest range, 10V.

Message Terminator	Marks the end of a command line. The following messages are in accordance with IEEE488.2 standard.	
	LF	Line feed code

Message Separator ; (semicolon) Command separator.

## Command Set

- Commands are **non**-case sensitive.
- Underline means a single space (dc\_1→DC 1V).
- When the parameter does not match the real value, the closest possible option is automatically selected (dc\_2 [DC 2V range]→DC 10V)

### CONFigure command

---

conf:volt:dc	Sets measurement to DC Voltage and specifies range. Parameter: NR2, min, max Example: conf:volt:dc_1 (DCV, 1V range) Example: conf:volt:dc_min (DCV, minimum range)
conf:volt:ac	Sets measurement to AC Voltage and specifies range. Parameter: NR2, min, max Example: conf:volt:ac_1 (ACV, 1V range) Example: conf:volt:ac_min (ACV, minimum range)
conf:volt:dcac	Sets measurement to DC+AC Voltage and specifies range. Parameter: NR2, min, max Example: conf:volt:dcac_1 (DC+ACV, 1V range) Example: conf:volt:dcac_min (DC+ACV, minimum range)
conf:curr:dc	Sets measurement to DC Current and specifies range. Parameter: NR2, min, max Example: conf:curr:dc_10e-3 (DCI, 10mA range) Example: conf:curr:dc_min (DCI, minimum range)
conf:curr:ac	Sets measurement to AC Current and specifies range. Parameter: NR2, min, max Example: conf:curr:ac_10e-2 (ACI, 100mA range) Example: conf:curr:ac_min (ACI, minimum range)
conf:curr:dcac	Sets measurement to DC+AC Current and specifies range. Parameter: NR2, min, max Example: conf:curr:dcac_10 (DC+ACI, 10A range) Example: conf:curr:dcac_min (DC+ACI, minimum range)
conf:res	Sets measurement to 2W Resistance and specifies range. Parameter: NR2, min, max Example: conf:res_10e3 (2W R, 10K range) Example: conf:res_min (2W R, minimum range)
conf:fres	Sets measurement to 4W Resistance and specifies range. Parameter: NR2, min, max Example: conf:fres_10e3 (4W R, 10K range) Example: conf:fres_min (4W R, minimum range)
conf:freq	Sets measurement to Frequency and specifies range.

conf:per	Sets measurement to Period and specifies range.
conf:cont	Sets measurement to Continuity.
conf:diod	Sets measurement to Diode.
conf:temp	Sets measurement to Temperature.
conf:stat:func?	Returns function of 1 <sup>st</sup> display. Parameter: 1 (DCV), 2 (ACV), 3 (DCA-10A), 4 (ACA-10A), 5 (DCA-mA), 6 (ACA-mA), 7 (2WR), 8 (Freq), 9 (TempC), 10 (AC+DCA-10A), 11 (AC+DCV), 12 (AC+DCA-mA), 13 (Diode), 14 (Period), 15 (TempF), 16 (4WR), 17 (Cont.)
conf:stat:rang?	Returns range of 1 <sup>st</sup> display. Parameter: DCV: 1 (100mV), 2 (1V), 3(10V), 4 (100V), 5 (1000V) ACV: 1 (100mV), 2 (1V), 3(10V), 4(100V), 5(750V) AC+DCV: 1 (100mV), 2 (1V), 3(10V), 4 (100V), 5 (1000V) DCmA, ACmA, ACmA+DCmA: 1(10mA), 2(100mA), 3(1A) 2WR, 4WR: 1(100Ω), 2(1kΩ), 3(10kΩ), 4(100kΩ), 5(1MΩ), 6(10MΩ), 7(100MΩ) DCA, ACA, AC+DCA (10A range): 1 (one range) Freq, TempC, TempF, Diode, Period, Cont.: 1 (one range)
conf:auto	Set 1 <sup>st</sup> display to Auto range. Parameter: 0 (disable auto range), 1 (enable auto range)
conf:auto?	Return 1 <sup>st</sup> display Auto range status. Parameter: 0 (disable auto range), 1 (enable auto range)

## SENSE command

sens:det:rate	Sets detection rate. Parameter: s (slow), m (medium), f (fast) Example: sens:det:rate_s (set detection rate to Slow)
sens:det:rate?	Returns detection rate. Parameter: Slow, Mid, Fast
sens:temp:tco:type	Sets thermocouple type. Parameter: j (type J), k (type K), t (type T) Example: sens:temp:tco:type_j (set thermocouple type to J)
sens:temp:tco:type?	Returns thermocouple type. Parameter: J (type J), K (type K), T (type T)
sens:temp:rjun:sim	Set temperature simulation value. Parameter: NR2 Example: sens:temp:rjun:sim_23
sens:temp:rjun:sim?	Returns temperature simulation value.

sens:aver:tcon	Selects digital filter type. Parameter: mov (moving), rep (repeating) Example: sens:aver:tcon_mov (moving digital filter)
sens:aver:tcon?	Returns digital filter type. Parameter: MOV (moving), REP (repeating)
sens:aver:coun	Sets digital filter count. Parameter: 2 ~ 100 Example: sens:aver:coun_100 (filter count 100)
sens:aver:coun?	Returns current digital filter count. Parameter: 2 ~ 100
sens:aver:stat	Turns digital filter On/Off. Parameter: Boolean Example: sens:aver:stat_1 (digital filter On)
sens:aver:stat?	Returns digital filter status, On or Off. Parameter: Boolean

## UNIT command

unit:temp	Selects temperature unit, celsius or fahrenheit. Parameter: c (celsius), f (fahrenheit) Example: unit:temp_c (temperature unit celsius)
unit:temp?	Returns temperature unit, celsius or fahrenheit. Parameter: C (celsius), F (fahrenheit)

## CALCulate command

calc:func	Activates advanced measurement functions. Parameter: rel (relative), max (Max), hold (Hold), dbm (dBm), db (switches between dB, dB+dBV, and dB+dBm), math (Math), comp (Compare) Example: calc:func_math (activate math function) Example: calc:func_db (activate dB) calc:func_db (second issue activate dB+dBV(dBm)) calc:func_db (third issue activate dB+dBm(dBV))
calc:func?	Returns current advanced measurement functions. Parameter: rel (relative), max (Max), hold (Hold), dbm (dBm), DB-V (dB-dBV), DB-M (dB-dBm), math (Math), comp (Compare)
calc:stat	Turns math function On/Off. Parameter: Boolean Example: calc:stat_1 (math function On)
calc:stat?	Returns math function status, On or Off. Parameter: Boolean

calc:aver:min?	Returns minimum value stored.
calc:aver:max?	Returns maximum value stored.
calc:aver:aver?	Returns average value stored.
calc:aver:coun?	Returns number of data count.
calc:rel:ref	Sets reference value in Relative value measurement. Parameter: NR2, min, max Example: calc:rel:ref_1.0 (reference value set to 1.0)
calc:rel:ref?	Returns reference value in Relative value measurement. Parameter: NR2, min, max
calc:db:ref	Sets reference value in dB measurement. Parameter: NR2, min, max Example: calc:db:ref_1.0 (reference value set to 1.0)
calc:db:ref?	Returns reference value in dB measurement. Parameter: NR2, min, max
calc:dbm:ref	Sets reference value in dBm measurement. Parameter: NR2, min, max Example: calc:db:ref_1.0 (reference value set to 1.0)
calc:dbm:ref?	Returns reference value in dBm measurement. Parameter: NR2, min, max
calc:lim:low	Sets lower limit value in Compare measurement. Parameter: NR2, min, max Example: calc:lim:low_1.0 (lower limit set to 1.0)
calc:lim:low?	Returns lower limit value in Compare measurement. Parameter: NR2, min, max
calc:lim:upp	Sets upper limit value in Compare measurement. Parameter: NR2, min, max Example: calc:lim:low_1.0 (upper limit set to 1.0)
calc:lim:upp?	Returns upper limit value in Compare measurement. Parameter: NR2, min, max
calc:math:mmf	Sets factor(M) in Math measurement. Parameter: NR2 Example: calc:math:mmf_1.03 (Math factor set to 1.03)
calc:math:mmf?	Returns factor(M) in Math measurement. Parameter: NR2
calc:math:mbf	Sets offset(B) in Math measurement. Parameter: NR2 Example: calc:math:mbf_10 (Math offset set to 10)
calc:math:mbf?	Returns offset(B) in Math measurement. Parameter: NR2

---

calc:math:perc	Sets target value in Math measurement. Parameter: NR2 Example: calc:math:perc_50 (target set to 50)
calc:hold:ref	Set percentage of Hold function. Parameter: 0 to 99, min, max
calc:hold:ref?	Return percentage of Hold function. Parameter: 0 to 99

---

## TRIGger command

---

read?	Returns 1 <sup>st</sup> and 2 <sup>nd</sup> display value.
val1?	Returns 1 <sup>st</sup> display value.
val2?	Returns 2 <sup>nd</sup> display value.
trig:sour	Selects trigger source. Parameter: int (internal), ext (external) Example: trig:sour_ext (External trigger selected)
trig:sour?	Returns current trigger source. Parameter: INT (internal), EXT (external)
trig:del	Sets trigger delay in milli-seconds. Parameter: 0 ~ 9999, min, max Example: trig:del_50 (trigger delay set at 50ms) Example: trig:del_min (trigger delay set at minimum 1ms)
trig:del?	Returns trigger delay in milli-seconds. Parameter: 0 ~ 9999, min, max
trig:auto	Turns trigger auto mode On or Off. Parameter: 1 (on), 0 (off) Example: trig:auto_1 (trigger auto mode On)
trig:auto?	Returns current trigger auto mode. Parameter: 1 (on), 0 (off)
samp:coun	Sets number of sampling. Parameter: NR1 (1 to 127) Example: samp:coun_10 (sampling set at 10)
samp:coun?	Returns number of sampling. Parameter: NR1 (1 to 127)
trig:coun	Sets number of trigger counting. Parameter: NR1 (1 to 127) Example: trig:coun_100 (trigger count set at 100)
trig:coun?	Returns number of trigger count. Parameter: NR1 (1 to 127)
trac:data?	Returns buffer contents.

---

---

trac:cle	Clears buffer contents.
----------	-------------------------

---

## SYStem related command

---

sys:disp	Turns display On or Off. Parameter: Boolean Example: disp_1 (display On)
sys:disp?	Returns display status, On of Off. Parameter: Boolean
sys:beep:stat	Select beep mode. Parameter: 0 (Off), 1 (Pass), 2 (Fail) Example: syst:beep:stat_1 (Beep when pass)
sys:beep:stat?	Returns beep mode status. Parameter: No beep, Beep on Pass, Beep on Fail
sys:err?	Returns current system error, if there is any.
sys:vers?	Returns system version. Parameter: 1.00 ~
*rst	Reset system.
*idn?	Returns company name, model No., and system version. Example: GW, GDM8255A, 1.0

---

## STAtus reporting command

---

stat:ques:enab	Enable bits in the Questionable Data register.
stat:ques:enab?	Returns Questionable Data register contents in decimal number.
stat:ques:even?	Returns Questionable Data event register contents in decimal number.
stat:pres	Clear Questionable Data enable register.

---

## RS-232C interface command

---

sys:loc	Enables front panel control and disables remote control
sys:rem	Enables remote control and disables front panel control

---

## IEEE 488.2 common command

---

*cls	Clears event status register (Output Queue, Operation Event Status, Questionable Event Status, Standard Event Status)
*ese?	Returns ESER (Event Status Enable Register) contents. Example: 130 means ESER=10000010

---



*ese <0~255>	Sets ESER contents. Example: *ese 65 sets ESER to 01000001
*esr?	Returns and clears SESR (Standard Event Status Register). Example: 198 means SESR=11000110
*idn?	Returns company name, model No., and system version. Example: GW, GDM8255A, 1.0
*opc?	“1” is placed in the output queue when all the pending operations are completed.
*opc	Sets operation complete bit (bit0) in SERS (Standard Event Status Register) when all pending operations are completed.
*psc?	Returns power On clear status. Parameter: 0 (cleared), 1 (not cleared)
*psc	Clears power On status. Parameter: 0 (clear), 1 (don't clear)
*rst	Recalls default panel setup (reset the device).
*sre?	Returns SRER (Service Request Enable Register) contents. Example: 3 means SRER=00000011
*sre <0~255>	Sets SRER contents. Example: *SRE 7 SRER=00000111
*stb?	Returns SBR (Status Byte Register) contents. Example: 81 means SBR=01010001
*trg	Manually triggers the GDM-8200A series.

## ROUTE command

rout:clos	Close specified scanner channel. Parameter: NR1, min, max Example: rout:clos_102 (close channel102)
rout:open:all	Opens all scanner channels.
rout:mult:open	Enable all channels in specified range. Parameter: beginning channel, end channel Example: rout:mult:open 105, 110 (105 to 110 enabled, others disabled)
rout:mult:clos	Disable all channels in specified range. Parameter: beginning channel, end channel Example: rout:mult:clos 105, 110 (105 to 110 disabled, others enabled)
rout:mult:stat?	Returns scanner box all channel status. Parameter: 101 ON, 102 OFF, .... 201 ON, 202 OFF...

route:chan	Configure channel in advanced mode. Parameter: Channel, Function, Range, Auto Range Example: route:chan 101, 1, 2, 0 (Channel 101, Function 1 (DCV), Range 2 (DCV 1V), Disable Auto Range)
route:chan?	Return channel configurations in advanced mode. Parameter: Channel, Function, Range, Auto Range Example: 101, 1, 2, 0 (Channel 101, Function 1 (DCV), Range 2 (DCV 1V), Disable Auto Range)
route:del	Set delay timer for scan. Parameter: 0 to 9999 (ms)
route:del?	Return delay timer setting for scan. Parameter: 0 to 9999 (ms)
route:coun	Set number of count for scan. Parameter: 1 to 999
route:coun?	Return number of count for scan. Parameter: 1 to 999
route:func	Enable scan related functions. Parameter: 0 (scan off), 1 (monitor), 2 (step), 3 (scan), 4 (advance)
route:func?	Return scan related function status. Parameter: 0 (scan off), 1 (monitor), 2 (step), 3 (scan)

## Secondary display: CONFigure2 command

conf2:volt:dc	Configure 2 <sup>nd</sup> display to DC Voltage. Parameter: NR2, min, max Example: conf2:volt:dc_1 (DC Voltage, 1V range)
conf2:volt:ac	Configure 2 <sup>nd</sup> display to AC Voltage. Parameter: NR2, min, max Example: conf2:volt:ac_1 (AC Voltage, 1V range)
conf2:curr:dc	Configure 2 <sup>nd</sup> display to DC Current. Parameter: NR2, min, max Example: conf2:curr:dc_10e-3 (DC Current, 10mA range)
conf2:curr:ac	Configure 2 <sup>nd</sup> display to AC Current. Parameter: NR2, min, max Example: conf2:curr:ac_10e-3 (AC Current, 10mA range)
conf2:res	Configure 2 <sup>nd</sup> display to 2W Resistance. Parameter: NR2, min, max Example: conf2:res_10e2 (2W Resistance, 1kΩ range)
conf2:fres	Configure 2 <sup>nd</sup> display to 4W Resistance. Parameter: NR2, min, max Example: conf2:fres_10e2 (Resistance, 1kΩ range)

conf2:freq	Configure 2 <sup>nd</sup> display to Frequency.
conf2:per	Configure 2 <sup>nd</sup> display to Period.
conf2:temp	Configure 2 <sup>nd</sup> display to Temperature.
conf2:off	Turn off the dual display mode (2 <sup>nd</sup> display is off)
conf2:stat:func?	Returns function of 2 <sup>nd</sup> display. Parameter: 1 (DCV), 2 (ACV), 3 (DCA-10A), 4 (ACA-10A), 5 (DCA-mA), 6 (ACA-mA), 7 (2WR), 8 (Freq), 9 (TempC), 10 (AC+DCA-10A), 11 (AC+DCV), 12 (AC+DCA-mA), 13 (Diode), 14 (Period), 15 (TempF), 16 (4WR), 17 (Cont.)
conf2:stat:rang?	Returns range of 2 <sup>nd</sup> display. Parameter: DCV: 1 (100mV), 2 (1V), 3(10V), 4 (100V), 5 (1000V) ACV: 1 (100mV), 2 (1V), 3(10V), 4(100V), 5(750V) AC+DCV: 1 (100mV), 2 (1V), 3(10V), 4 (100V), 5 (1000V) DCA, ACA, AC+DCA: 1(10mA), 2(100mA), 3(1A) 2WR, 4WR: 1(100Ω), 2(1kΩ), 3(10kΩ), 4(100kΩ), 5(1MΩ), 6(10MΩ), 7(100MΩ) DCA, ACA, AC+DCA (10A range): 1 (one range) Freq, TempC, TempF, Diode, Period, Cont.: 1 (one range)
conf2:auto	Set 2 <sup>nd</sup> display to Auto range. Parameter: 0 (disable auto range), 1 (enable auto range)
conf2:auto?	Return 2 <sup>nd</sup> display Auto range status. Parameter: 0 (disable auto range), 1 (enable auto range)

# FAQ

---

- What is the Output key used for?
  - I pressed the EXIT key but cannot get out of Scanner mode.
  - The GDM-8200A series performance does not match the specifications.
- 

## **What is the Output key used for?**

The Output key is used for turning the display output on or off.

---

## **I pressed the EXIT key but cannot get out of Scanner mode.**

Press the EXIT key, followed by the ACV (Scan) or DCV (Step) key.

---

## **The GDM-8200A series performance does not match the specifications.**

Make sure the device is powered On for at least 30 minutes, within +18°C~+28°C. This is necessary to stabilize the unit to match the specifications.

---

If there is still a problem, please contact your local dealer or GWInstek at [marketing@goodwill.com.tw](mailto:marketing@goodwill.com.tw).



# APPENDIX

---

System Info	Firmware Version.....	109
Fuse Replacement	Replace AC source fuse .....	111
	Replace input current fuse.....	112
Specifications	General.....	113
	Reading rates (readings/sec).....	113
	DC Voltage.....	113
	AC Voltage .....	114
	DC Current .....	115
	AC Current.....	116
	2W Resistance .....	116
	4W Resistance .....	117
	Diode/Continuity.....	118
	Frequency .....	118
Temperature .....	118	

---

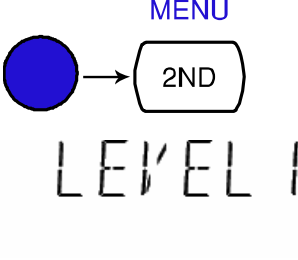
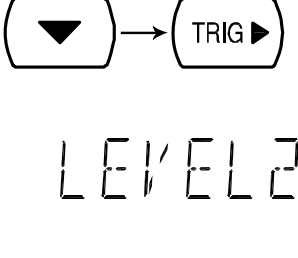
# Firmware Version

Background	Firmware version is available for viewing system information.	
	Firmware version	Shows the GDM-8200A series firmware version number.
View firmware version	1. Press the Shift key followed by the 2ND (Menu) key. The system menu appears.	
	2. Press the Down key followed by the Right key. The firmware version menu appears.	
	3. Press the Down key. The firmware version appears.	
	4. Press the Exit key to go back to the default display.	

# Fuse Replacement

## Replace AC source fuse

---

Step

1. Take off the power cord and remove the fuse socket using a minus driver.

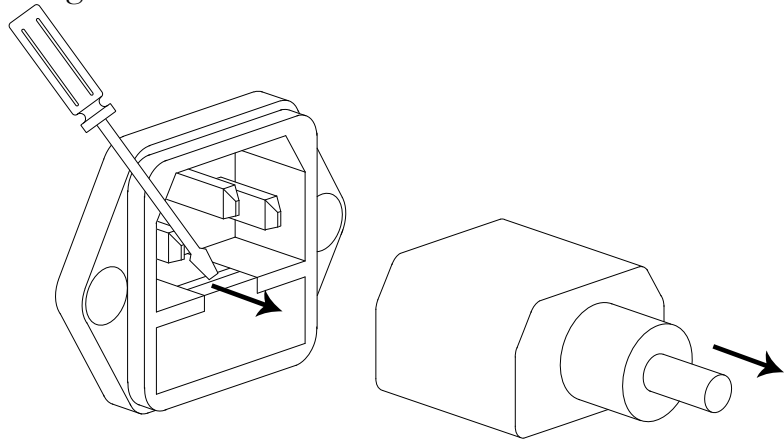

2. Replace the fuse in the holder.

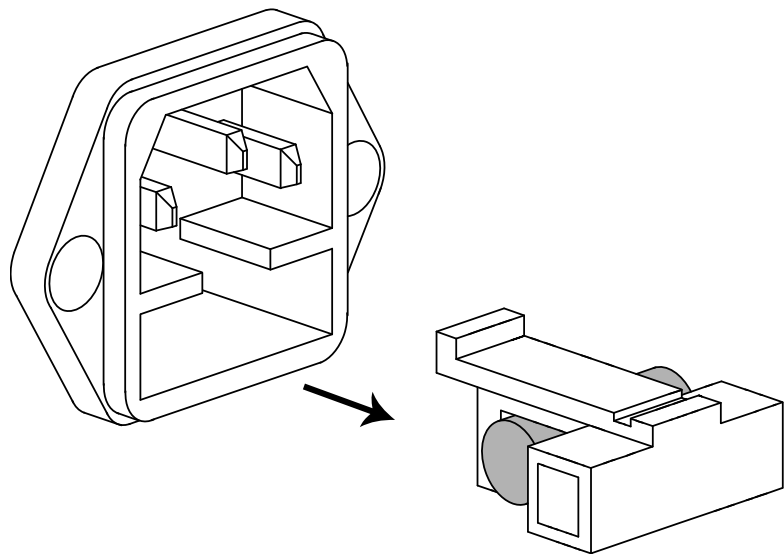

Rating

T3.15A, 250V

## Replace input current fuse

- Step 1. Press the Fuse holder.

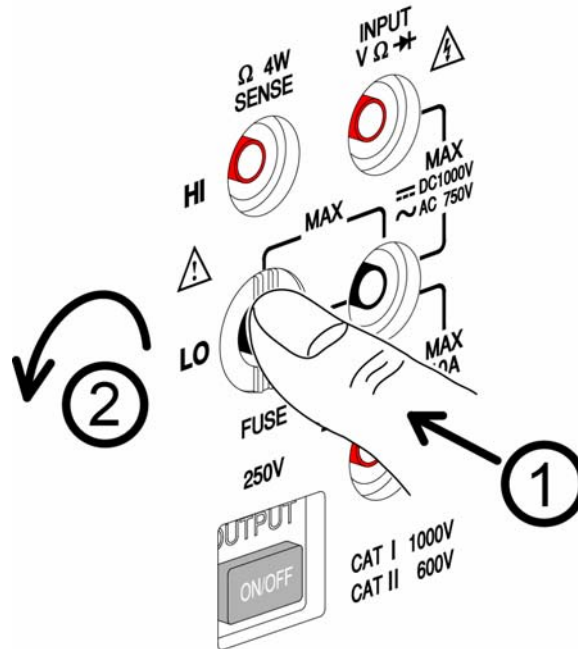

2. The fuse holder comes out. Replace the fuse inserted at the end of the holder.

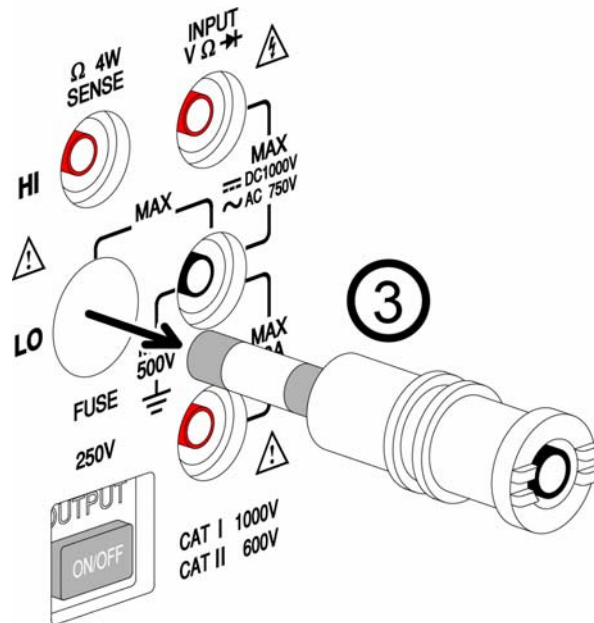

Rating T2A, 250V



# Specifications

## General



Note

- All specifications are ensured only under a single display.
- At least 30 minutes of warm-up time is required before applying these specifications.
- Make sure the power ground is connected.

	Type	Digit
Resolution	Slow (S)	5 ½ Digit
	Medium (M)	4 ½ Digit
	Fast (F)	3 ½ Digit
Operation Environment	Ambient Temperature 0°C ~ 40°C, Relative Humidity < 75% (For full accuracy: 18°C ~ 28°C)	
Temperature Coefficient	< 0.2 x applicable accuracy per degree (°C) (for 0°C ~ 18°C and 28°C ~ 40°C)	
Storage Environment	Ambient Temperature -10°C ~ 70°C Relative Humidity: 0°C ~ 35°C < 75%, 35°C ~ 50°C < 50%	
Power Source	AC 100-240V ± 10%, 50-60Hz	
Dimension	265(W) x 107(H) x 350(D) mm	
Weight	Approx. 2.6kg without option	

## Reading rates (readings/sec)

Function	Rate		
	S	M	F
DCV	10	30	60
DCI	10	30	60
ACV	1	5	20
ACI	1	5	20
2/4WΩ (10M/100MΩ)	1	1.5	2
2/4WΩ (others)	3	5	8
ACV+DCV	0.5	1	3
ACI+DCI	0.5	1	3
Diode	30	30	60

## DC Voltage



Note

- Max. Input: 1000V DC or Peak on all range
- Total accuracy of (AC + DC) voltage does not exceed the sum of AC voltage accuracy and DC voltage accuracy

Rate	Range	Resolution	Full Scale (8251A)	Full Scale (8255A)	Accuracy
S	100.000mV	1μV	120.000mV	199.999mV	0.012%+8
	1.00000V	10μV	1.20000V	1.99999V	0.012%+5
	10.0000V	100μV	12.0000V	19.9999V	0.012%+5
	100.000V	1mV	120.000V	199.999V	0.012%+5
	1000.00V	10mV	1000.00V	1000.00V	0.012%+5
M	100.00mV	10μV	120.00mV	199.99mV	0.012%+5
	1.0000V	100μV	1.2000V	1.9999V	0.012%+5
	10.000V	1mV	12.000V	19.999V	0.012%+5
	100.00V	10mV	120.00V	199.99V	0.012%+5
	1000.0V	100mV	1000.0V	1000.0V	0.012%+5
F	100.0mV	100μV	120.0mV	199.9mV	0.012%+2
	1.000V	1mV	1.200V	1.999V	0.012%+2
	10.00V	10mV	12.00V	19.99V	0.012%+2
	100.0V	100mV	120.0V	199.9V	0.012%+2
	1000V	1V	1000V	1000V	0.012%+2

## AC Voltage



Note

- Specifications are for sine wave input > 5% of range
- (\*) Input > 450V only for 30sec, < 200V for 20 ~ 45Hz
- Total accuracy of (AC + DC) voltage does not exceed the sum of AC voltage accuracy and DC voltage accuracy

Rate	Range	Resolution	Full Scale (GDM-8251A)	Full Scale (GDM-8255A)
S	100.000mV	1μV	120.000mV	199.999mV
	1.00000V	10μV	1.20000V	1.99999V
	10.0000V	100μV	12.0000V	19.9999V
	100.000V	1mV	120.000V	199.999V
	750.00V(*)	10mV	750.00V	750.00V
M	100.00mV	10μV	120.00mV	199.99mV
	1.0000V	100μV	1.2000V	1.9999V
	10.000V	1mV	12.000V	19.999V
	100.00V	10mV	120.00V	199.99V
	750.0V(*)	100mV	750.0V	750.0V
F	100.0mV	100μV	120.0mV	199.9mV
	1.000V	1mV	1.200V	1.999V

	10.00V	10mV	12.00V	19.99V	
	100.0V	100mV	120.0V	199.9V	
	750V(*)	1V	750V	750V	
Rate	Range	Accuracy (reading%+digits)			
		20~45Hz	45~10kHz	10k~30kHz	30k~100kHz
S	100.000mV	1% + 100	0.2% + 100	1.5% + 300	5% + 300
	1.00000V	1% + 100	0.2% + 100	1% + 100	3% + 200
	10.0000V	1% + 100	0.2% + 100	1% + 100	3% + 200
	100.000V	1% + 100	0.2% + 100	1% + 100	3% + 200
	750.00V(*)	1% + 100	0.2% + 100	1% + 100	3% + 200
M	100.00mV	—	0.2% + 40	1.5% + 80	5% + 120
	1.0000V	—	0.2% + 40	1% + 40	3% + 80
	10.000V	—	0.2% + 40	1% + 40	3% + 80
	100.00V	—	0.2% + 40	1% + 40	3% + 80
	750.0V(*)	—	0.2% + 40	1% + 40	3% + 80
F	100.0mV	—	0.2% + 5	1.5% + 10	5% + 15
	1.000V	—	0.2% + 5	1% + 5	3% + 10
	10.00V	—	0.2% + 5	1% + 5	3% + 10
	100.0V	—	0.2% + 5	1% + 5	3% + 10
	750V(*)	—	0.2% + 5	1% + 5	3% + 10

### DC Current



Note

- mA range protected with a 2A fuse
- 10A range protected with a 12A, 600V fuse
- 10A only for 30 seconds

Rate	Range	Resolu- tion	Full Scale GDM-8251A	Full Scale GDM-8255A	Accuracy (reading%+ digits)
S	10.0000mA	0.1μA	12.0000mA	19.9999mA	0.05%+15
	100.000mA	1μA	120.000mA	199.999mA	0.05%+5
	1.0000A	100μA	1.2000A	1.9999A	0.2%+5
	10.0000A	100μA	10.0000A	10.0000A	0.2%+5
M	10.000mA	1μA	12.000mA	19.999mA	0.1%+6
	100.00mA	10μA	120.00mA	199.99mA	0.1%+3
	1.000A	1mA	1.200A	1.999A	0.2%+3
	10.000A	1mA	10.000A	10.000A	0.2%+3
F	10.00mA	10μA	12.00mA	19.99mA	0.1%+2
	100.0mA	100μA	120.0mA	199.9mA	0.1%+2
	1.00A	10mA	1.20A	1.99A	0.2%+2
	10.00A	10mA	10.00A	10.00A	0.2%+2

## AC Current



Note

- The following ac current specifications are for sinusoidal signals with amplitudes greater than 5% of its range.
- mA range protected with a 2A fuse
- 10A range protected with a 12A, 600V fuse
- 10A range specifications are verified for < 5kHz

Rate	Range	Resolution	Full Scale (GDM-8251A)	Full Scale (GDM-8255A)
S	10.0000mA	0.1μA	12.0000mA	19.9999mA
	100.000mA	1μA	120.000mA	199.999mA
	1.0000A	100μA	1.2000A	1.9999A
	10.0000A	100μA	10.0000A	10.0000A
M	10.000mA	1μA	12.000mA	19.999mA
	100.00mA	10μA	120.00mA	199.99mA
	1.000A	1mA	1.200A	1.999A
	10.000A	1mA	10.000A	10.000A
F	10.00mA	10μA	12.00mA	19.99mA
	100.0mA	100μA	120.0mA	199.9mA
	1.00A	10mA	1.20A	1.99A
	10.00A	10mA	10.00A	10.00A

### Accuracy (reading%+digits)

Rate	Range	20 ~ 50Hz	50 ~ 10kHz	10k ~ 20kHz
S	10.0000mA	1.5% + 100	0.5% + 100	2% + 200
	100.000mA	1.5% + 100	0.5% + 100	2% + 200
	1.0000A	—	1% + 100	—
	10.0000A	—	1% + 100	—
M	10.000mA	—	0.5% + 40	2% + 80
	100.00mA	—	0.5% + 12	2% + 30
	1.000A	—	—	—
	10.000A	—	—	—
F	10.00mA	—	0.5% + 5	2% + 10
	100.0mA	—	0.5% + 2	2% + 5
	1.00A	—	—	—
	10.00A	—	—	—

## 2W Resistance



Note

- Max. Input: 500V DC or 500V rms AC
- \*: Relative mode

Rate	Range	Full Scale (GDM-8251A)	Full Scale (GDM-8255A)	Accuracy reading%+digits
------	-------	------------------------	------------------------	--------------------------

S	100.000Ω	120.000Ω	199.999Ω	0.1% + 8*
	1.00000kΩ	1.20000kΩ	1.99999kΩ	0.08% + 5*
	10.0000kΩ	12.0000kΩ	19.9999kΩ	0.06% + 5*
	100.000kΩ	120.000kΩ	199.999kΩ	0.06% + 5
	1.00000MΩ	1.20000MΩ	1.99999MΩ	0.06% + 5
	10.0000MΩ	12.0000MΩ	19.9999MΩ	0.3% + 5
	100.000MΩ	120.000MΩ	199.999MΩ	3.0% + 8
M	100.00Ω	120.00Ω	199.99Ω	0.1% + 5*
	1.0000kΩ	1.2000kΩ	1.9999kΩ	0.08% + 3*
	10.000kΩ	12.000kΩ	19.999kΩ	0.06% + 3
	100.00kΩ	120.00kΩ	199.99kΩ	0.06% + 3
	1.0000MΩ	1.2000MΩ	1.9999MΩ	0.06% + 3
	10.000MΩ	12.000MΩ	19.999MΩ	1.5% + 3
	100.00MΩ	120.00MΩ	199.99MΩ	5.0% + 5
F	100.0Ω	120.0Ω	199.9Ω	0.1% + 2*
	1.000kΩ	1.200kΩ	1.999kΩ	0.08% + 2
	10.00kΩ	12.00kΩ	19.99kΩ	0.06% + 2
	100.0kΩ	120.0kΩ	199.9kΩ	0.06% + 2
	1.000MΩ	1.200MΩ	1.999MΩ	0.06% + 2
	10.00MΩ	12.00MΩ	19.99MΩ	1.5% + 2
	100.0MΩ	120.0MΩ	199.9MΩ	5.0% + 2

### 4W Resistance



Note

- Max. Input: 500V DC or 500V rms AC

Rate	Range	Full Scale (GDM-8251A)	Full Scale (GDM-8255A)	Accuracy reading%+digits
S	100.000Ω	120.000Ω	199.999Ω	0.05% + 8
	1.00000kΩ	1.20000kΩ	1.99999kΩ	0.05% + 5
	10.0000kΩ	12.0000kΩ	19.9999kΩ	0.05% + 5
	100.000kΩ	120.000kΩ	199.999kΩ	0.05% + 5
	1.00000MΩ	1.20000MΩ	1.99999MΩ	0.05% + 5
	10.0000MΩ	12.0000MΩ	19.9999MΩ	0.3% + 5
	100.000MΩ	120.000MΩ	199.999MΩ	3.0% + 8
M	100.00Ω	120.00Ω	199.99Ω	0.05% + 5
	1.0000kΩ	1.2000kΩ	1.9999kΩ	0.05% + 3
	10.000kΩ	12.000kΩ	19.999kΩ	0.05% + 3
	100.00kΩ	120.00kΩ	199.99kΩ	0.05% + 3
	1.0000MΩ	1.2000MΩ	1.9999MΩ	0.05% + 3
	10.000MΩ	12.000MΩ	19.999MΩ	1.5% + 3
	100.00MΩ	120.00MΩ	199.99MΩ	5.0% + 5
F	100.0Ω	120.0Ω	199.9Ω	0.05% + 2
	1.000kΩ	1.200kΩ	1.999kΩ	0.05% + 2

10.00kΩ	12.00kΩ	19.99kΩ	0.05% + 2
100.0kΩ	120.0kΩ	199.9kΩ	0.05% + 2
1.000MΩ	1.200MΩ	1.999MΩ	0.05% + 2
10.00MΩ	12.00MΩ	19.99MΩ	1.5% + 2
100.0MΩ	120.0MΩ	199.9MΩ	5.0% + 2

## Diode/Continuity



Note

- Max. Input: 500V DC or 500V rms AC

Item	Range	Accuracy (reading%+digits)
Diode	Approx. 2V, 0.5mA	0.025% + 5
Continuity	1 ~ 1000Ω	0.08% + 5

## Frequency



Note

- Max. Input: 750V rms or 1000V peak

Frequency	Sensitivity	Accuracy (reading%+digits)
10Hz ~ 100kHz	0.1V	0.05% + 15
100kHz ~ 600kHz	1V	0.05% + 3
600kHz ~ 800kHz	2.5V	0.05% + 3

## Temperature



Note

- Sensor errors excluded from Temperature specifications

	Type	Measurement Range
Thermo Couple	K	0 ~ +300°C
	T	0 ~ +300°C
	J	0 ~ +300°C
Resolution	0.1°C (0 ~ 300°C)	

## Optional Scanner

Channel	2-wire: 16 pairs, 4-wire: 8 pairs, single-wire: N/A
Maximum voltage	250V
Maximum current	2A (ch17, ch18)
Resistance	2/4 wire
Cold junction	N/A (internal)
Connection	Screw terminal

# EC Declaration of Conformity

We  
**GOOD WILL INSTRUMENT CO., LTD.**  
 (1) No.7-1, Jhongsing Rd., Tucheng City, Taipei County, Taiwan  
 (2) No. 69, Lu San Road, Suzhou City (Xin Qu), Jiangsu Sheng, China  
 declare, that the below mentioned product

Type of Product: **Digital Multimeter**  
 Model Number: **GDM-8255A / GDM-8251A**

are herewith confirmed to comply with the requirements set out in the Council Directive on the Approximation of the Law of Member States relating to Electromagnetic Compatibility (2004/108/EC) and Low Voltage Directive (2006/95/EC).  
 For the evaluation regarding the Electromagnetic Compatibility and Low Voltage Directive, the following standards were applied:

◎ EMC

EN 61326-1: Electrical equipment for measurement, control and laboratory use — EMC requirements (2006)	
Conducted & Radiated Emission EN 55011: 1998 + A1: 1999 + A2: 2002, Class B	Electrostatic Discharge EN 61000-4-2: 1995 + A1: 1998 + A2: 2001
Current Harmonics EN 61000-3-2: 2000 + A2: 2005	Radiated Immunity EN 61000-4-3: 2002 + A1: 2002
Voltage Fluctuations EN 61000-3-3: 1995 + A1: 2001 + A2: 2005	Electrical Fast Transients EN 61000-4-4: 2004
-----	Surge Immunity EN 61000-4-5: 1995 + A1: 2001
-----	Conducted Susceptibility EN 61000-4-6: 1996 + A1: 2001
-----	Power Frequency Magnetic Field EN 61000-4-8: 1993 + A1: 2001
-----	Voltage Dip/ Interruption EN 61000-4-11: 2004

◎ Safety

Low Voltage Equipment Directive 2006/95/EC
Safety Requirements IEC/EN 61010-1: 2001

# INDEX

<b>2</b>	
2nd display	
front panel key .....	16
measurement overview.....	55
<b>B</b>	
beeper	
command set .....	104
setting.....	35
<b>C</b>	
compare value	
command set .....	102
setting.....	49
continuity	
front panel key .....	14
scanner configuration.....	73
setting.....	33
specifications.....	118
crest factor .....	27
current	
front panel key .....	14
scanner configuration.....	73
setting.....	28
specifications.....	115
<b>D</b>	
dB	
command set .....	102
front panel key .....	14
setting.....	43
digital filter	
command set .....	101, 103
front panel key .....	16
setting.....	62
diode test	
front panel key .....	14
scanner configuration.....	73
setting.....	32
specifications.....	118
display on/off .....	65
display setting command set.....	104
<b>E</b>	
EN 55011 declaration of conformity ....	119
EN 61010	
declaration of conformity .....	119
measurement category .....	6
pollution degree .....	7
environment	
operation .....	7
specifications .....	113
storage.....	7
<b>F</b>	
FAQ.....	108
firmware version.....	110
command set.....	104
frequency	
command set.....	104
front panel key.....	14
scanner configuration.....	73
setting .....	36
specifications .....	118
fuse	
AC fuse replacement .....	111
current fuse replacement.....	112
safety instruction .....	7
<b>G</b>	
getting started chapter.....	9
<b>I</b>	
indicator .....	23
<b>K</b>	
key lock.....	65
<b>M</b>	
main feature list .....	11
math	



command set .....	102	front panel key .....	13
front panel key .....	14	step operation .....	86
setting .....	52	scanner	
monitor channel .....	87	command set .....	105
<b>O</b>		get out of scanner mode .....	108
output key faq .....	108	series lineup .....	10
<b>P</b>		service contact .....	108
period		specification conditions .....	108
front panel key .....	14	<b>T</b>	
scanner configuration .....	73	table of contents .....	3
setting .....	36	temperature	
power supply safety instruction .....	6	front panel key .....	15
<b>R</b>		scanner configuration .....	73
Recall instrument settings .....	70	setting .....	37
Recall measurements .....	68	specifications .....	118
refresh rate .....	22	thermocouple	
command set .....	100	command set .....	100
front panel key .....	15	front panel key .....	15
relative value		setting .....	38
command set .....	102	specifications .....	118
front panel key .....	15	tilt stand .....	19
setting .....	46	trigger	
resistance		delay .....	60
command set .....	100	external .....	59
front panel key .....	14	front panel key .....	15
scanner configuration .....	73	<b>U</b>	
setting .....	30	United Kingdom power cord .....	8
specifications .....	116, 117	USB configuration .....	95
RS-232C configuration .....	96	<b>V</b>	
<b>S</b>		voltage	
safety instruction		front panel key .....	13
fuse .....	7	scanner configuration .....	73
power supply .....	6	setting .....	24
symbol .....	5	specifications .....	114
Save instrument settings .....	69	<b>W</b>	
Save measurements .....	67	waveforms voltage comparison .....	26
scan operation			