

2010

General Line Catalog



EDSYN[®]

...bringing innovative ideas to life

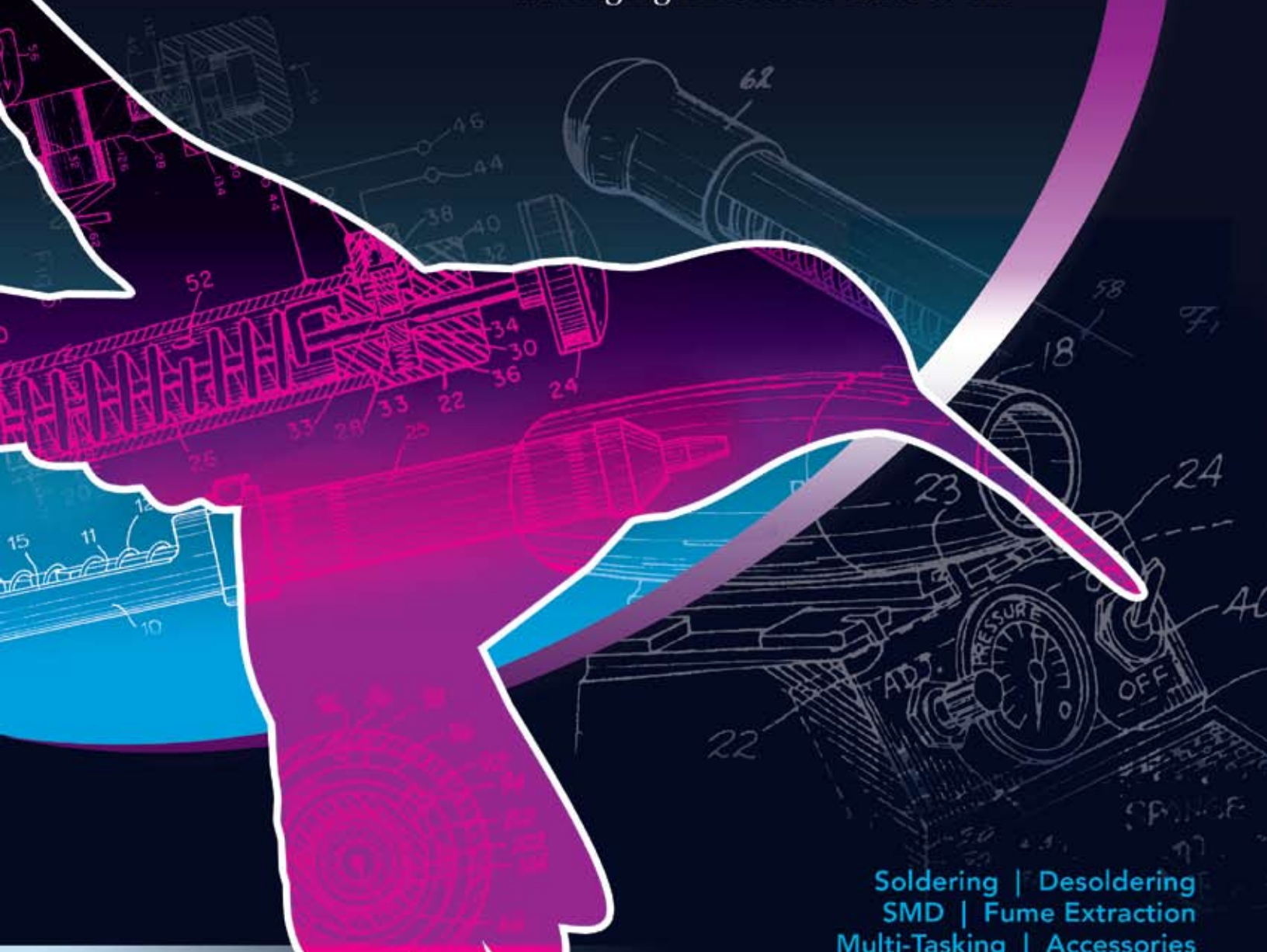

Soldering | Desoldering
SMD | Fume Extraction
Multi-Tasking | Accessories

www.edsyn.com

EDSYN SIGNIFICANT EVENTS

Soldapullt® is invented

Edsyn is incorporated

Loner® soldering instrument invented

Edsyn GmbH Europa opens in Germany



1961



1964



1971



1981



EDSYN INC

PAST, PRESENT & FUTURE

...bringing innovative ideas to life

Some say you make a living by what you receive, but here at Edsyn we believe you only make a good living by what you give. It's not a common philosophy in today's world, yet we feel it is intrinsic to Edsyn's success over the past 49 years and is the key to our continuing success for the future. The meaning of Edsyn – *Engineering Dedicated to Suit Your Needs* - reflects a unique philosophy and was originally created by Edsyn's founders, Bill and Shirley Fortune.

Bill and Shirley have always cared about people. When Bill started out as a technician in a Los Angeles-based company in the early 1960s, his job involved removing solder in various applications. Unfortunately, he found the techniques of the time outdated, difficult, and time-consuming, so he decided to work nights in his garage to make the job easier for himself and for his fellow technicians. Bill soon developed the perfect solution to his dilemma. His wife, Shirley, quickly named this little invention the *Soldapullt®* and the rest, as they say, is "history." This ground-breaking technology launched an industry revolution and the birth of Edsyn. Over the next four decades Bill continued creating his inventions, which Shirley always named and marketed under the Edsyn brand. Their four daughters – Lori, Jeani, Sheri, and Juli – also shared in producing hundreds of Bill's inventions for a variety of industries worldwide.

Bringing innovative ideas to life - it's a long-standing tradition at Edsyn and one of the reasons we have such a long and rich history.

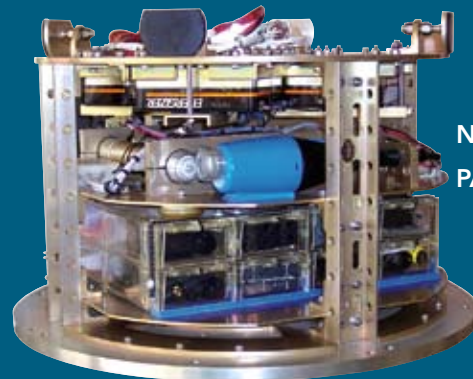

NASA
PAYLOAD

Bill has always felt a keen interest in, and admiration for, German engineering and wished to introduce his brand of engineering to Europe. In the 1980s he expanded the Edsyn family to include a German office, Edsyn GmbH Europa. Successfully managed for nearly 30 years by Mr. Franz Furtner, Edsyn GmbH Europa has earned a distinguished place in the European market. Now headed by Mr. Furtner's daughter, Christiane Furtner, Edsyn GmbH Europa continues to spearhead Edsyn's engineering efforts in Germany.

Because of the success of the German office, Bill and Shirley took an interest in the British market. In 1995, the Fortunes opened up an office in England headed by their daughter, Juli, and Ms. Angela Greenidge.





1983



1995



1997



2009

Edsyn UK Ltd. is now recognized in England, Ireland, Scotland, and Wales as a company that offers the finest quality products and services for the electronics industry.

Currently, we are still busy manufacturing Edsyn products in our California-based factory. Bill now works with a team of engineers in Edsyn's Research & Development Lab also located there. It makes us all proud that Edsyn is still producing in California and providing jobs to our family of employees. In fact, we are one of the last remaining manufacturers of soldering and desoldering equipment in the United States. We operate out of two factory buildings employing approximately 25 workers along with two subsidiaries located in England and Germany. Each tool is carefully

and meticulously handcrafted at our factory and we feel it's a privilege to take care of and respond to our customer's needs in every way possible. Some of our key innovations include not just a few industry firsts as you can see listed below.

We celebrate the fact that Edsyn has been in operation for almost 50 years and remains a family-owned and managed business. Edsyn's quest for well-engineered and innovative products continues, and although Bill is now entering his 80s, he is still passionate about inventing and expanding our family of products worldwide. When asked what he likes most about Edsyn, a warm, proud smile spread across Bill's face: "it's always nice to hear from a customer who has had your product for over 40 years."



Edsyn's key innovations and highlights over the past 49 years:

1. First patented hand held desoldering pump. Trademark name: **Soldapullt**®
2. First patented temperature controlled soldering instrument. Trademark name: **Loner**®
3. First patented hot air SMT rework station. Trademark name **Atmoscope**®
4. First patented rotating bench top fume extractor. Trademark name: **Fuminator**®
5. First patented air and vacuum lifting tool that uses air pressure to lift components without direct contact. Trademark name: **Soldavac**®
6. First in Space. In the 1980's Edsyn flew on two NASA Getaway Special programs and successfully conducted experiments involving new soldering systems and techniques especially designed for space.
7. First patented portable and cordless soldering station with a lead acid battery that is ideally suited for production environments with energy saving needs. Model no.: PSS2000
8. First totally lead free micro-processor controlled system designed to handle current and future needs of the expanding global environment. Model no.: 2020



TABLE OF CONTENTS

12-29



SOLDERING

Edsyn has created a complete line of *Loner*® soldering instruments, stations and tips to suit your needs. In this section you will be introduced to the tried and true and the bold and new.

30-37



DESOLDERING

In 1961 Edsyn invented the industry's first patented desoldering hand tool known as the *Soldapullt*® and launched an industry revolution that continues to this day. In this section, you will discover a variety of desoldering solutions from the simple to the complex.

38-47



SMT

Edsyn's SMT solutions are perfect for micro rework applications and work with pinpoint accuracy and temperature control. Each station is designed for high performance in a small footprint and offers unique versatility and outstanding performance.

48-63



MULTI-TASKING

See how Edsyn integrates a combination of Edsyn products for unique site preparation problems. All solutions provide multi-tasking capabilities for limited bench spaces. Now technicians with even novice skills can consistently deliver superior professional results.

64-73



FUME EXTRACTION

Edsyn values a safe working environment and has provided a full range of fume extraction solutions called the *Fuminator*® line. From smaller bench top units to heavy duty volume fume extraction systems, all of our solutions are manufactured to strict quality standards and are virtually maintenance free.

74-81

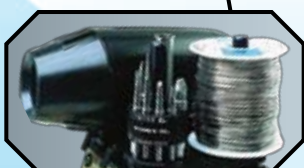

ACCESSORIES

Edsyn's new line of accessories and production aids are specifically designed to complement our current line of soldering, desoldering and SMT stations. In this section you will find a wide variety of hand tools and production aids that fit most any assembly and rework requirement. You will be sure to find the perfect tool for a perfect job at any budget.

© Copyright 2010 by
Edsyn Incorporated

All Rights Reserved

No part of this catalog, including the individual icons, may be reproduced or utilized in any form or by any means without the written permission of Edsyn Incorporated.

The names LONER, ATMOSCOPE, SOLDAPULLT, SOLDAVAC, AUTO-VAC, IDLE-REST, OCTAVAC, KLATCH, FUMINATOR, SILVERSTAT, and WIGAPRY are proprietary trademarks of Edsyn Incorporated. Most products are covered by US and foreign patents and pending applications. Design, color, weight and material subject to change without notice. Tip style on tools may vary.

• **Mission Statement**

Edsyn's mission is to bring innovative ideas to life through quality engineering and commitment to high performance designs dedicated to suit the needs of our customers.

• **Vision Statement**

The Vision of Edsyn is one based on its desire to continue to grow and develop as a manufacturer and produce a working environment and company that its employees are proud to be a part of.

Our vision therefore is to:

- Build a reputation as an organization that responds to the rapidly changing needs of our customers
- Continue to provide outstanding quality customer service
- Proactively seek new initiatives for the overall benefit of our stakeholders

• **Values Statement**

The corporate values that shape the character and development of Edsyn include our ability to be honest, trustworthy and fair in our relationships with customers, suppliers and employees. Edsyn listens and responds to the needs of its stakeholders and takes its role in concern for the environment seriously.

We encourage creative thinking and innovation amongst our employees and put quality at the center of our management and manufacturing processes.

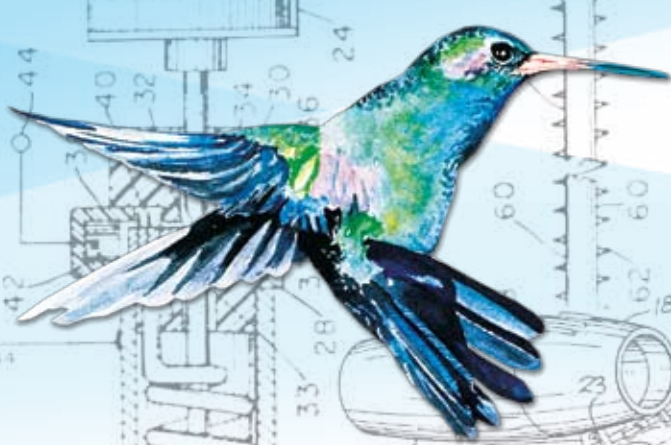
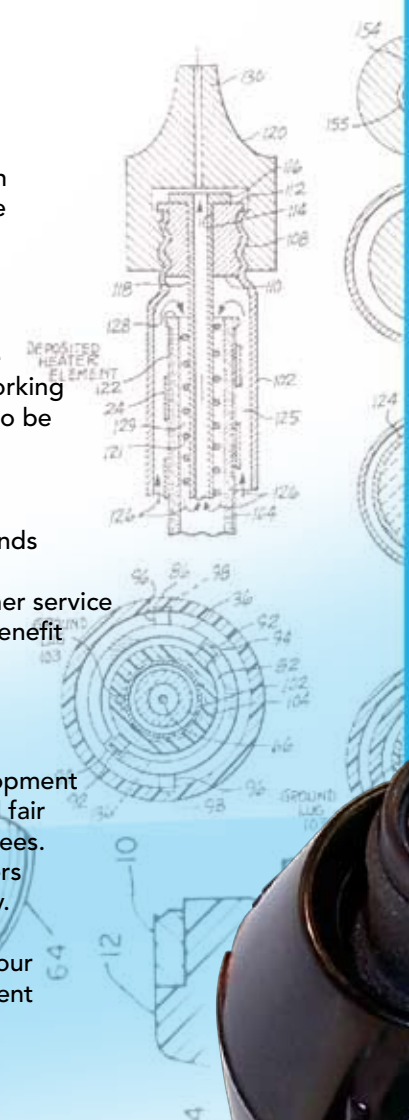
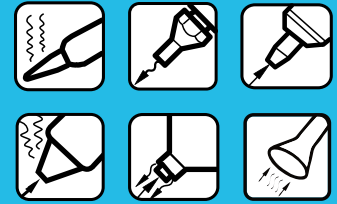

Fig.5



Customer Service & Edsyn

Edsyn - Engineering Dedicated to Suit Your Needs

We believe your success is our success and we are equally committed to both. To us customer service means a helpful and friendly attitude along with personalized attention. We will never take your business for granted and will demonstrate this by providing the following outstanding customer service policy. After all, it's what Edsyn's name stands for:

Engineering

Edsyn promises innovative ideas from the inventors who engineer and manufacture the latest in cutting-edge technology. The professionals at our Van Nuys, California factory have unsurpassed experience in the development, production and service of the products in this catalog and the unique needs of the electronics industry.

Dedicated

Edsyn promises dedicated factory service and support to our loyal family of customers. We provide no-hassle customer service even "after the sale" by an experienced network of sales representatives, worldwide distributors and subsidiaries, top customer service personnel, engineers, and leading technicians.

to Suit Your Needs

At Edsyn taking care of business is like taking care of family. Our philosophy and customer approach is designed to suit the customer's needs first because our customers are the reason why we are in business. That is why Edsyn is dedicated to bringing innovative ideas to life with the best in customer service.

For nearly 50 years, the majority of Edsyn products have been designed, manufactured or assembled at our factory in Van Nuys, California. We believe in providing the highest quality products and service and have a dedicated staff of nearly 30 employees. We also provide the best factory warranty in the business for the majority of our products - 18 months. We believe this sets the performance standard that the competition can only try to match. Our customer service and support people are standing by to help:

	Customer Service	Sales	Hummerworks
Telephone	818.989.2324	818.989.2324	818.989.2324
Fax	818.997.0460	818.997.0895	818.997.0895
Email	customerservice@edsyn.com	sales@edsyn.com	engineering@edsyn.com

NEW Hummerworks Service



Introducing Hummerworks Service

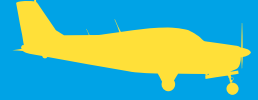

At Edsyn we are continually reaching out to find better solutions to keep us all productive and self-supportive in our home markets. Because research and development is our passion and the driving force behind our name, we are now offering our dedicated engineering services to provide the solutions and innovative ideas to make your personal business thrive and grow no matter where you live. Here's how Edsyn **Hummerworks Service** can work for you:

Engineering Services

Edsyn Hummerworks provides R & D services designed to work hand-in-hand with organizations to meet their specific engineering needs, enabling them to succeed in the global market. Market dynamics have made it imperative for businesses to innovate and roll out products and services at a faster pace and at lower costs. Partnering with the right company to build these products correctly the first time and co-innovate in new technology is critical to success.

Dedicated Services

For nearly 50 years Edsyn's R & D team of professionals have demonstrated unsurpassed experience in the development, manufacturing and production of successful and marketable products unique to the electronics industry. We now offer these dedicated services to suit the unique needs of your industry.

Services to Suit Your Needs

Because businesses need to innovate and roll out products and services at a faster pace we have made Edsyn Hummerworks available by land or air. Edsyn provides their very own Cirrus Airplane equipped flight department as a productivity tool to help suit your organization's particular needs at a much faster rate so you can keep your competitive advantage no matter where you live.

Call to schedule a free consultation with Edsyn Hummerworks today!

Hummerworks	
Telephone	818.989.2324
Fax	818.997.0895
Email	engineering@edsyn.com

Edsyn Incorporated
15958 Arminta Street
Van Nuys, CA 91406
Tel: 818.989.2324
Fax: 818.997.0895
email: sales@edsyn.com
www.edsyn.com

Edsyn GmbH Europa
Finkenweg 2
Kreuzwertheim
D-97892 Germany
Tel: +49 (0) 9342.6413
Fax: +49 (0) 9342.6417
email: edsyn-europa@
t-online.de
www.edsyn-europa.de

Edsyn UK Limited
Zeal House
Unit 8 Deer Park Road
London, SW19 3GW
Tel: +44 (0) 208.417.0990
Fax: +44 (0) 208.417.0666
email: sales@edsyn.eu
www.edsyn.com



Edsyn goes green

Look for this symbol



RoHS Compliance & Edsyn - *Restriction of Hazardous Substances* - is a directive for the European Union (EU) that became enforceable on July 1, 2006. It is normally referred to as the 'Lead Free Directive' but it actually contains six hazardous substances that are limited for manufacturing use. To be compliant, manufacturers may not place "new Electrical and Electronic Equipment (EEE) containing lead, mercury, cadmium, hexavalent chromium, polybrominated biphenyls (PBB) and polybrominated diphenyl ethers (PBDE), in amounts exceeding the set maximum concentration values, on the market in the EU". Complying with this directive helps to make disposal of products containing these hazardous substances less toxic and cleaner for the environment as well as decreasing the health risks associated with them.

How does Edsyn comply? Edsyn values the environment and its customers by complying with the RoHS directive even when it does not have to in the United States. Moreover, in January 2007, US legislature required all Edsyn products sold in California to meet the standards found in the *California Clean Water Act*. Some of these same standards were also required under the RoHS directive. Therefore, Edsyn felt it was very important to comply with all applicable RoHS standards no matter where our customers lived. This means that Edsyn is a fully compliant RoHS manufacturing facility in California and all of our stations, new tips, and applicable products are RoHS compliant no matter where they are sold.

Edsyn feels compliance with this directive and others like it are very important because these standards help reduce damage to people and the environment especially in third-world countries where much of today's "high-tech trash" ends up.

Besides being better for the environment, being RoHS compliant means that the use of lead-free solders and components provides immediate health benefits to our customers in prototype and manufacturing operations. Also for customers that use solder paste, contact with this substance now no longer represents the same health hazard as it did in times past.

We believe this helps all of us live up to Edsyn's mission to continue **bringing innovative ideas to life** for generations to come.

● Lead-Free Tip Statement

As our industry continues the transition to Lead-Free manufacturing processes, Edsyn has continued to provide our customers with the products they need to remain competitive with their product offerings. To that end, we began using Lead-Free solder to tin our soldering and desoldering tips in 2003. This means that virtually all genuine Edsyn replacement tips are approved for use in Lead-Free processes.

● Look for the "LF" Soldering Tip Series

The LF tips series is specifically designed for the higher temperatures used in Lead-Free processes. The iron plating is harder and slightly thicker than our standard plating and therefore dramatically increases the tip life. Over time, all of our soldering tips will be available in the new high temperature versions.

● High Temperature Rated Tips

There are a series of tip styles that are now available for either high temperature or high heat transfer applications. These tips are made with a high temperature plating process and are specially designed for the higher temperatures used in Lead-Free processes. The plating used is harder and slightly thicker than our standard plating and tip life is significantly increased with this new plating process. Look for the series of part numbers that include these prefixes or suffixes:

Soldering: LF ● BC ● XP
Desoldering: ZD



SOLDERING

Stations pgs 12 - 19
Irons & Kits pgs 20 - 21
Tips pgs 22 - 29



Edsyn engineers patented the first temperature controlled soldering instrument in 1971 and trademarked it Loner[®] because it stood in a class of its own. Decades later and still using this trademark, Edsyn has created a complete line of Loner[®] soldering instruments, stations and tips to suit your needs. In this section you will be introduced to the tried and true and bold and new.

Manufactured or assembled solely at its factory in Van Nuys, California and backed by an 18 month warranty - Edsyn sets the performance standard that the competition can only hope to match.

2020





Features

- Our most advanced soldering system featuring a compact design with digital display
- Temperature set back & temperature lock-out
- °F/ °C display options
- Modular sponge tray
- Universal switching power supply
- Passcode lockout
- Push button external calibration
- Internationally approved power supply
- RoHS compliant
- ESD safe
- 18 month warranty

Contents

- 2020 High performance digital soldering station includes LST13-2 soldering iron and XP375 tip
- PD528 Tool pod
- SH235 Modular sponge tray with RS200 round cleaning sponge
- WP556 WIGAPRY® mini screwdriver and calibration aid tool

Models & Specifications	2020	2020-230	2020-230B
Power Requirements	100V-240V, 50-60Hz	100V-240V, 50-60Hz	100V-240V, 50-60Hz
Power Rating	60W	60W	60W
Heater Rating	24V, 53W	24V, 53W	24V, 53W
Plug/Power Supply	USA Standard 	European 	British 
Weight	3 lbs (1.36 kg)		
Overall Dimension	7"W x 5½"H x 4"D (178 mm x 140 mm x 102 mm)		
Temperature Range	450°F-850°F (232°C-454°C)		
Temperature Regulation	±6°F (±3°C)		
Tip-to-Ground Voltage Leakage/Resistance	< 2mV / < 2 ohms		



www.edsyn.com

930



Features

- Self-contained soldering instrument with temperature control dial located right on the 'nothing-to-hide' clear view handle
- Uses a wide variety of tips
- Convenient wick and solder dispenser located in tool base (wick and solder supply sold separately)
- Detachable tool pod allows instant storage in tool box or central security cabinet
- High temperature versions available calibrated to 1000°F or 1200°F (please call for details)
- ESD safe
- 18 month warranty

Contents

930	Soldering station includes CL1080 soldering instrument with LT375 tip
IP329	IDLE REST® soldering tool base includes PD528 tool pod
SH230	Sponge holder includes RS199 cleaning sponge, RS243 leveling pad, and LN230 sponge liner

Options available

SW094	Solder wick (5 ft)
-------	--------------------

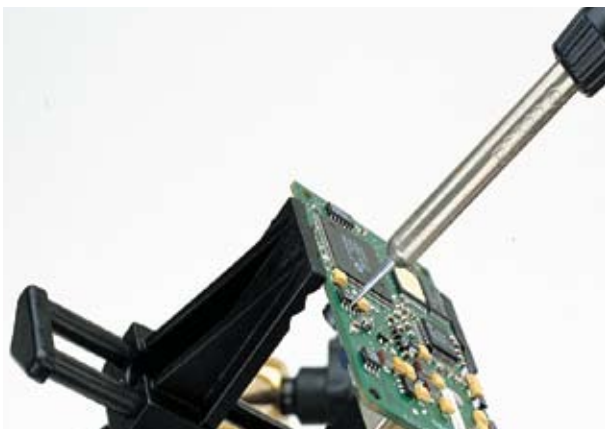

Specifications for Model 930

Power Requirements	120V, 60Hz	
Power Rating	9W - 70W	
Heater Rating	120V, 95W	
Temperature Range	400°F-800°F (205°C-427°C)	
Temperature Regulation	±6°F (±3°C)	
Tip-to-Ground Voltage Leakage/Resistance	< 2mV/< 2 ohms	
Overall Dimension	4.1"W x 8.5"H x 10"D	
	104 mm x 216 mm x 254 mm	
Weight	2 lbs (1.0 kg)	

935



Features

- Self-contained soldering instrument with temperature control dial located right on the 'nothing-to-hide' clear view handle
- Uses a wide variety of tips
- Power supply includes easy plug-in port for soldering instrument
- High temperature versions available calibrated to 1000°F or 1200°F (please call for details)
- ESD safe
- 18 month warranty

Contents

- 935 Soldering station with CL1080 soldering instrument, with LT375 tip and PD528 tool holder
- PS536 Power supply soldering tool base
- SH230 Sponge holder includes RS199 cleaning sponge, RS243 leveling pad, and LN230 sponge liner



Specifications for Model 935

Power Requirements	120V, 60Hz	
Power Rating	9W - 70W	
Heater Rating	120V, 95W	
Temperature Range	400°F-800°F (205°C-427°C)	
Temperature Regulation	±6°F (±3°C)	
Tip-to-Ground Voltage		
Leakage/Resistance	< 2mV/< 2 ohms	
Overall Dimension	4.1" W x 8.5" H x 10" D	
	104 mm x 216 mm x 254 mm	
Weight	3.5 lbs (1.6 kg)	



951SX





Features

- An industry standard, highly dependable and cost efficient
- Accurate linear temperature control dial
- Easy to maintain and calibrate with external calibration feature
- Modular assembly for easy service and maintenance
- Wide variety of soldering and SMT CROWN[®] tips available
- International and high temperature models available calibrated to 1000°F or 1200°F (please call for details)
- ESD safe
- 18 month warranty

Contents

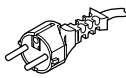
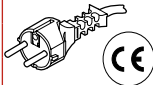
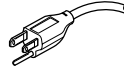
951SX	Temperature controlled soldering station includes LT375 tip
PD528	Tool pod
SH230	Sponge holder includes RS199 cleaning sponge, RS243 leveling pad, LN230 sponge liner
WP556	WIGAPRY [®] mini screwdriver and calibration aid tool

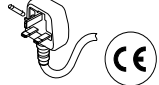
Models & Specifications	951SX	951SX-230	951DX-230	951SX-230I	951SX-230B	951DX-230B
Power Requirements	120V, 60Hz	230V, 50-60Hz	230V, 50Hz	230V, 50Hz	230V, 50Hz	230V, 50Hz
Power Rating	15W - 220W	15W-220W	18W - 160W	15W - 220W	15W - 220W	18W - 160W
Heater Rating	120V, 95W	230V, 95W	24V, 53W	230V, 95W	230V, 95W	24V, 53W
Plug	USA Standard 	European 	European 	USA Standard 	British 	British 
Weight	2.5 lbs (1.4 kg)	2.5 lbs (1.4 kg)	4 lbs (1.8 kg)	2.5 lbs (1.4 kg)	2.5 lbs (1.4 kg)	4 lbs (1.8 kg)
Overall Dimension	4.1"W x 8.2"H x 10"D (104 mm x 208 mm x 254 mm)					
Temperature Range	400°F-800°F (205°C-427°C)					
Temperature Regulation	±6°F (±3°C)					
Tip-to-Ground Voltage Leakage/Resistance	< 2mV / < 2 ohms					



952SX





Features

- Dual soldering station offers both versatility and cost efficiency
- Temperature controlled standard soldering and heavy duty soldering available in one unit
- Easy to maintain and calibrate with external calibration feature
- Modular assembly for easy service and maintenance
- Wide variety of soldering and SMT CROWN® tips available
- International and high temperature models available calibrated to 1000°F or 1200°F (please call for details)
- ESD safe
- 18 month warranty

Contents

952SX	Dual temperature controlled soldering station includes LT375 and LT338BC tips
PD528	Includes two tool pods
SH230	Sponge holder includes RS199 cleaning sponge, RS243 leveling pad, LN230 sponge liner
WP556	WIGAPRY® mini screwdriver and calibration aid tool

Models & Specifications	952SX	952DX-230	952DX-230B
Power Requirements	120V, 60Hz	230V, 50Hz	230V, 50Hz
Power Rating	15W - 220W	36W - 320W	36W - 320W
Heater Rating	120V, 95W	24V, 53W	24V, 53W
Plug	USA Standard 	European 	British 
Weight	3.1 lbs (1.4 kg)	6 lbs (2.7 kg)	6 lbs (2.7 kg)
Overall Dimension	4.1"W x 8.2"H x 10"D (104 mm x 208 mm x 254 mm)		
Temperature Range	400°F - 800°F (205°C-427°C)		
Temperature Regulation	±6°F (±3°C)		
Tip-to-Ground Voltage & Leakage/Resistance	< 2mV / < 2 ohms		



971









Features

- An advanced soldering station with precise temperature control that delivers rapid heat-up and recovery times
- New direct tip-to-heater design provides quicker recovery and better sensing as well as more accurate and stable temperatures at the tip
- Innovative handle design makes tip change quicker and easier
- Easy to maintain and calibrate with external calibration feature
- Accepts a wide variety of tips
- International models available
- ESD safe
- 18 month warranty

Contents

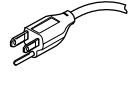
971	High performance temperature controlled soldering station includes LT375 tip
PD528	Tool pod
SH230	Sponge holder includes RS199 cleaning sponge, RS243 leveling pad, LN230 sponge liner
WP556	WIGAPRY® mini screwdriver and calibration aid tool

Models & Specifications	971	971DX-230	971-230B	971DX-230B	971-230I	971DX-230I
Power Requirements	120V, 60Hz	230V, 50Hz	230V, 50Hz	230V, 50Hz	230V, 50Hz	230V, 50Hz
Power Rating	15W - 220W	18W-160W	15W - 220W	18W - 160W	15W - 220W	18W - 160W
Heater Rating	120V, 95W	24V, 53W	230V, 95W	24V, 53W	230V, 95W	24V, 53W
Plug	USA Standard 	European 	British 	British 	USA Standard 	USA Standard 
Weight	2.6 lbs (1.5 kg)	5 lbs (2.3 kg)	2.6 lbs (1.5 kg)	5 lbs (2.3 kg)	2.6 lbs (1.5 kg)	5 lbs (2.3 kg)
Overall Dimension	4.1"W x 8.2"H x 10"D (104 mm x 208 mm x 254 mm)					
Temperature Range	400°F-800°F (205°C - 427°C)					
Temperature Regulation	±6°F (±3°C)					
Tip-to-Ground Voltage Leakage/Resistance	< 2mV / < 2 ohms					



PSS2000



Features

- First patented temperature controlled hybrid portable soldering system with built-in battery backup system ideally suited for production environments with energy saving needs
- Maintains preset temperature during both brown-outs or complete power outages for 3-6 hours
- Includes maintenance free rechargeable lead-acid battery
- Perfect for mobile installation or repair, avionics, and remote areas where there is no primary power source
- ESD safe
- 18 month warranty

Contents

PSS2000	Portable hybrid soldering system includes LST21 soldering tool and LT375 tip (solder spool sold separately)
PD528	Tool pod
SH235	Sponge holder with RS199 cleaning sponge
MCA01	Auto power adapter
MCA02	Switching adapter

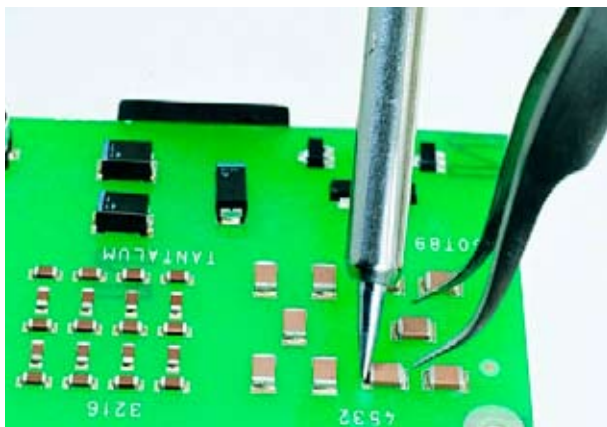

Specifications for Model PSS2000

Power Requirements	90-264 VAC	
Switching Adaptor Power Rating	25W	
Output Voltage	15VDC/1.67A	
Heater Rating	24V, 30W	
Temperature Range	400°F-800°F (205°C-427°C)	
Temperature Regulation	±6°F (±3°C)	
Overall Dimension	4.1"W x 8.5"H x 10"D 104 mm x 216 mm x 254 mm	
Weight	6 lbs (2.7 kg)	



CL1080



CL1180



CL1481



CL1080



- Self-contained soldering instrument with temperature control dial located right on the 'nothing-to-hide' clear view handle
- ESD safe
- Special models with higher maximum temperatures available calibrated to 1000°F or 1200°F (please call for details)

CL1180

- Excellent for hobby or professional use
- Portable
- Tamper-resistant temperature control
- ESD Safe

CL1481

- Economical without sacrificing quality
- Constant temperature
- ESD Safe

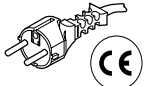
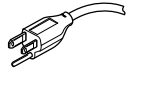
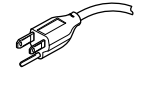
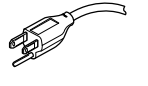
Models & Specifications	CL1080	CL1180	CL1280	CL1280I	CL1580I	CL1481
Power Requirements	120V, 60Hz	120V, 60Hz	230V, 50Hz	230V, 50Hz	230V, 50Hz	120V, 60Hz
Power Rating	9W - 70W	9W - 70W	70W	70W	9W - 70W	30W
Heater Rating	120V, 95W	120V, 95W	230V, 95W	230V, 95W	230V, 95W	120V, 30W
Plug	USA Standard 	USA Standard 	European 	USA Standard 	USA Standard 	USA Standard 
Weight	1 lb (.45 kg)					
Temperature Range	400°F-800°F (205°C - 427°C)					N/A
Temperature Regulation	±6°F (±3°C)					
Tip-to-Ground Voltage Leakage/Resistance	< 2mV / < 2 ohms					

Soldering Tool Holders

IP329



IP481



IP489



*IR089



*Suitable for CL1080 & CL1180 only

CL1080-K



CL1080-K

- LONER[®] Temperature controlled soldering instrument
- SOLDAPULLT[®] Static safe desoldering hand tool
- SOLDAPSIP[®] Desoldering wick
- TWIP[®] Solder and wick holster
- 5 piece soldering tip kit
- UL listed

CL1481-K



CL1481-K

- LONER[®] 30 watt soldering instrument
- SOLDAPULLT[®] Desoldering hand tool
- TWIP[®] Solder and wick holster
- Cutter and plier set
- SOLDASIP[®] Desoldering wick
- 2 piece soldering tip kit
- UL listed

EA73-105



EA73-105

- Rechargeable battery powered soldering tool
- Quick heat up in 15 seconds
- Tip temperature up to 700°F
- Built in work light
- Charger included
- UL listed

EA73-110



EA73-110

- Dual wattage soldering station
- Select between 20 and 40 watts
- Comes with holder and stand including sponge
- Replaceable tip (part number LT73)
- UL listed



Hollow Heater Soldering Tools and Stations

Part No.	Description
930	Soldering Station with CL1080 Soldering Tool and IP329 Base
935	Soldering Station with CL1080 Soldering Tool and PS536 Power Supply
951DX-230	Deluxe Soldering Station (includes all 230V models)
951SX	Soldering Station (includes all 230V models)
952DX-230	Dual Deluxe Soldering Station (includes all 230V models)
952SX	Dual Soldering Station (includes all 230V models)
CL1080	Temperature Controlled Soldering Tool
CL1180	Temperature Controlled Soldering Tool
CL1280I	Temperature Controlled Soldering Tool (230V)
CL1580I	Temperature Controlled Soldering Tool (230V)

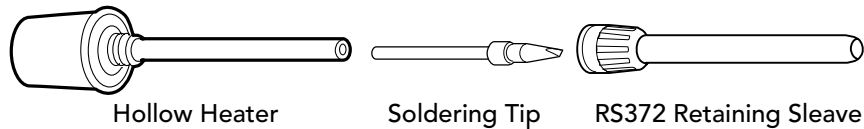

Hollow Threaded Heater Soldering Tools and Stations

Part No.	Description
CL1481	Constant Temperature Soldering Tool

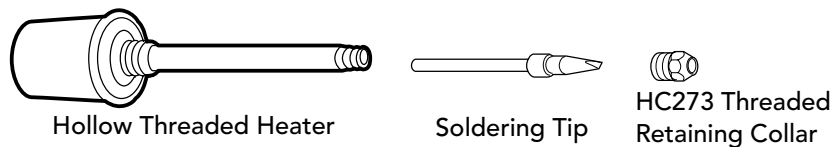

Hollow Heater Soldering Tools and Stations

Part No.	Description
PSS2000	Hybrid Portable Soldering System

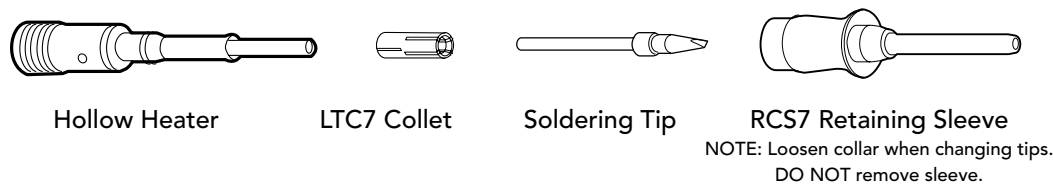

Front Loading Hollow Heater Soldering Tools and Stations

Part No.	Description
971	Deluxe High Performance Soldering Station (includes all 230V models)
971DX-230	Deluxe High Performance Soldering Station (includes all 230V models)
2020	Microprocessor Controlled Digital Soldering Station (includes all 230V models)

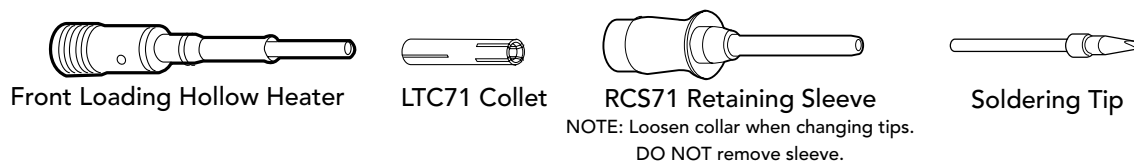



General Purpose Spade Tips

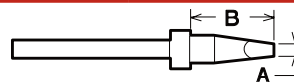

Part No.	Tip Image	Width A	Length B
LT375		.06" (1.5mm)	.48" (12.2mm)
LT376		.12" (3.0mm)	.48" (12.2mm)
LT394		.07" (1.8mm)	.93" (23.6mm)
LT395		.069" (2.3mm)	.74" (18.8mm)
LT431		.07" (1.8mm)	.74" (18.8mm)
LT444		.04" (1.0mm)	.78" (19.8mm)

General Purpose Conical Tips

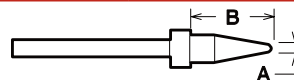

LT374		.03" (0.8mm)	.48" (12.2mm)
LT382		.02" (1.5mm)	.62" (15.8mm)
LT429		.02" (0.5mm)	.74" (18.8mm)

General Purpose Angled Conical Tip

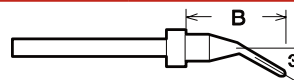





LT429-1		.02" (0.5mm)	.74" (18.8mm)
---------	--	--------------	---------------

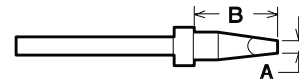

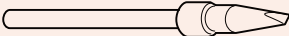
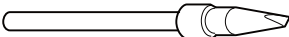

High Temperature Rated Spade Tips

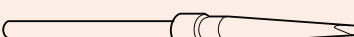
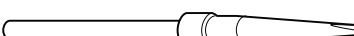
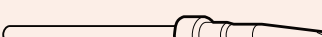

Part No.	Tip Image	Width A	Length B
LT371LF		.03" (0.8mm)	.55" (14.0mm)
LT375LF		.06" (1.5mm)	.48" (12.2mm)
LT376LF		.12" (3.0mm)	.48" (12.2mm)
LT394LF		.07" (1.8mm)	.93" (23.6mm)
LT395LF		.09" (2.3mm)	.74" (18.8mm)
LT424LF		.06" (1.5mm)	.74" (18.8mm)
LT425LF		.05" (1.3mm)	.93" (23.6mm)
LT431LF		.07" (1.8mm)	.74" (18.8mm)
LT444LF		.04" (1.0mm)	.78" (9.8mm)

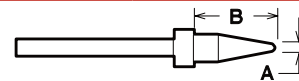
High Temperature Rated Conical Tips

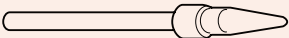
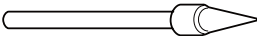
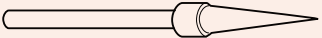

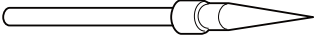
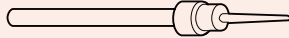
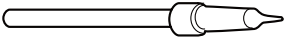
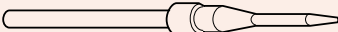
LT374LF		.03" (0.8mm)	.48" (12.2mm)
LT380LF		.02" (0.5mm)	.32" (8.1mm)
LT382LF		.02" (0.5mm)	.62" (15.8mm)
LT383LF		.02" (0.5mm)	.72" (18.3mm)
LT392LF		.01" (0.3mm)	1.13" (28.8mm)
LT429LF		.02" (0.5mm)	.74" (18.9mm)
LT439LF		.03" (0.8mm)	.50" (12.7mm)
LT446LF		.03" (0.8mm)	.48" (12.2mm)
LT603LF		.02" (0.5mm)	.69" (17.5mm)



High Temperature Rated Angle Face Tips

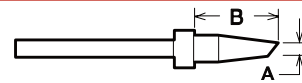

Part No.	Tip Image	Width A	Length B
LT298LF		.12" (3.1mm)	.59" (15.0mm)
LT299LF		.16" (4.0mm)	.59" (15.0mm)
LT373LF		.09" (2.3mm)	.59" (15.0mm)
LT387LF		.06" (1.5mm)	.48" (12.2mm)
LT393LF		.06" (1.5mm)	.94" (23.9mm)
LT398LF		.12" (3.0mm)	.59" (15.0mm)
LT399LF		.16" (4.0mm)	.59" (15.0mm)
LT430LF		.06" (1.5mm)	.74" (18.8mm)
LT433LF		.04" (1.2mm)	.69" (17.5mm)
LT443LF		.09" (5.6mm)	.69" (17.5mm)

High Temperature Rated Angled Spade Tips

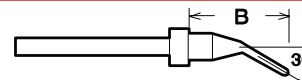

LT444-1LF		.064" (1.0mm)	.78" (9.8mm)
-----------	--	---------------	--------------

High Temperature Rated Angled Conical Tips

LT392-1LF		.01" (0.3mm)	1.13" (28.8mm)
LT439-1LF		.03" (0.8mm)	.50" (12.7mm)
LT602-1LF		.02" (0.5mm)	.44" (11.2mm)

High Temperature Rated Mini Flow Rework Tips

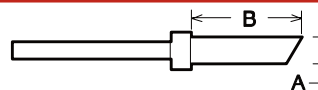

LT396LF		.13" (3.3mm)	.69" (17.5mm)
---------	--	--------------	---------------



Hollow Heater Soldering Tools and Stations

Part No.	Description
930	Soldering Station with CL1080 Soldering Tool and IP329 Base
935	Soldering Station with CL1080 Soldering Tool and PS536 Power Supply
951DX-230	Deluxe Soldering Station (includes all 230V models)
951SX	Soldering Station (includes all 230V models)
952DX-230	Dual Deluxe Soldering Station (includes all 230V models)
952SX	Dual Soldering Station (includes all 230V models)
CL1080	Temperature Controlled Soldering Tool
CL1180	Temperature Controlled Soldering Tool
CL1280I	Temperature Controlled Soldering Tool
CL1580I	Temperature Controlled Soldering Tool

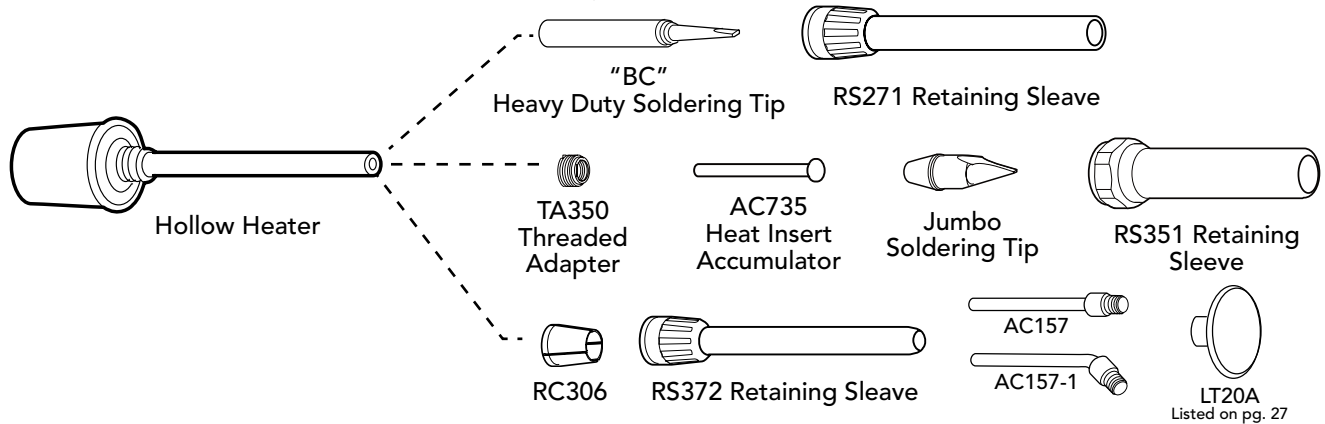

Heavy Duty Spade Tips

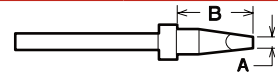

Part No.	Tip Image	Width A	Length B
HS106BC		.18" (4.6mm)	.45" (11.4mm)
LT336BC		.07" (1.8mm)	.74" (18.8mm)
LT337BC		.10" (2.5mm)	.74" (18.8mm)
LT338BC		.13" (3.3mm)	.74" (18.8mm)
LT441BC		.21" (5.3mm)	.94" (23.9mm)

Heavy Duty Angle Face Tips

LT339BC		.09" (2.3mm)	.77" (19.6mm)
LT340BC		.12" (3.0mm)	.77" (19.6mm)
LT341BC		.16" (4.0mm)	.77" (19.6mm)

Heavy Duty SMD Knife Tip

LT570BC		.17" (4.3mm)	.68" (17.3mm)
---------	--	--------------	---------------

Heavy Duty Jumbo Spade & Angle Tips

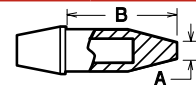

LT151B		.06" (1.5mm)	1.13" (28.7mm)
LT152B		.32" (8.1mm)	.89" (22.6mm)
LT155B		.33" (8.4mm)	.97" (24.6mm)



Front Loading Hollow Heater Soldering Tools and Stations

Part No.	Description
971	Constant Temperature Soldering Tool (includes all 230V models)
971DX-230	Deluxe High Performance Soldering Station (includes all 230V models)
2020	Microprocessor Controlled Digital Soldering Station (includes all 230V models)

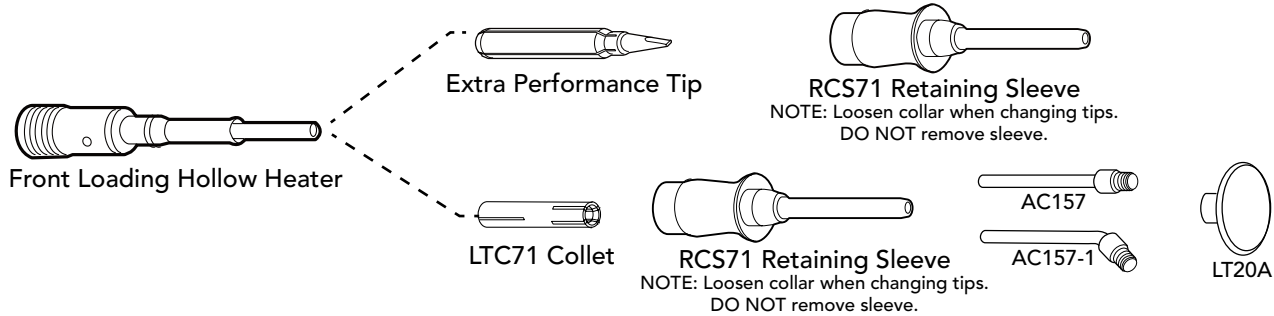

Heavy Duty Non-Plated Copper Leather Smoothing Tip

Part No.	Tip Image	Diameter	Length
LT20A		.79" (20mm)	N/A

Extra Performance Spade Tips



Part No.	Tip Image	Width A	Length B
XP371		.03" (.80mm)	.61" (15.5mm)
XP375		.06" (1.5mm)	.61" (15.5mm)
XP376		.12" (3.0mm)	.61" (21.2mm)
XP395		.09" (2.3mm)	.84" (21.2mm)
XP441		.20" (5.0mm)	.59" (15.0mm)
XP444		.04" (1.0mm)	.87" (22.0mm)

Extra Performance Conical Tips

XP374		.04" (.9mm)	.61" (15.5mm)
XP429		.02" (.6mm)	.83" (21.0mm)

Extra Performance Angle Face Tip

XP399		.20 (5.0mm)	.45 (11.5mm)
-------	--	-------------	--------------



Hollow Heater Soldering Tools and Stations

Part No.	Description
930	Soldering Station with CL1080 Soldering Tool and IP329 Base
935	Soldering Station with CL1080 Soldering Tool and PS536 Power Supply
951DX-230	Deluxe Soldering Station (includes all 230V models)
951SX	Soldering Station (includes all 230V models)
952DX-230	Dual Deluxe Soldering Station (includes all 230V models)
952SX	Dual Soldering Station (includes all 230V models)
CL1080	Temperature Controlled Soldering Tool
CL1180	Temperature Controlled Soldering Tool
CL1280I	Temperature Controlled Soldering Tool
CL1580I	Temperature Controlled Soldering Tool

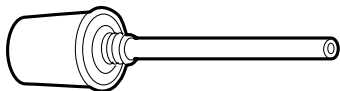

Hollow Heater

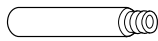

CTA02 Tip Adapter

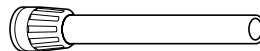

CTS71 Retaining Sleeve

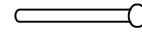

AC735 Heat Insert Accumulator

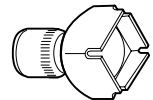

CROWN Tip

Hollow Threaded Heater Soldering Tools and Stations

Part No.	Description
CL1481	LONER Constant Temperature Soldering Tool

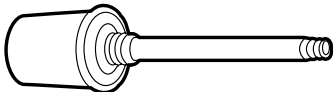

Hollow Threaded Heater

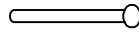

AC735 Heat Insert Accumulator

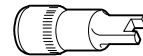

CROWN Tip

Hollow Threaded Heater Soldering Tools and Stations

Part No.	Description
971	LONER Deluxe High Performance Soldering Station (includes all 230V models)
971DX-230	LONER Deluxe High Performance Soldering Station (includes all 230V models)
2020	LONER Microprocessor Controlled Digital Soldering Station (includes all 230V models)

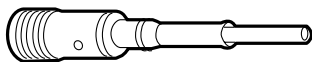

Front Loading Hollow Heater

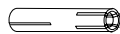

LTC71 Adapter

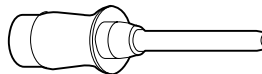

RCS71 Retaining Sleeve

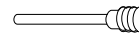

CTA03 Heat Insert Accumulator

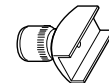

CROWN Tip

NOTE: Loosen collar when changing tips.
DO NOT remove sleeve.



CROWN® Series Contact Surface Mount Tips

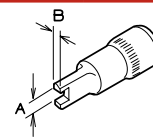

Part No.	Package	Tip Image	Width A	Length B
CT12	SOT-23		.07" (1.8mm)	.10" (2.5mm)
CT21	805		.09" (2.3mm)	.06" (1.5mm)
CT25	SOT-89		.10" (2.5mm)	.21" (5.3mm)
CT31	1206, 1210		.14" (3.5mm)	.07" (1.8mm)
CT42	1808, 1812		.19" (4.8mm)	.09" (2.3mm)
CT52	N/A		.20" (5.1mm)	.10" (2.5mm)
CT53	N/A		.23" (5.8mm)	.14" (3.5mm)

CROWN® Tunnel SMD Tips

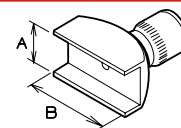

CT110	SOIC-18		.38" (9.5mm)	.40" (10.2mm)
CT113	SOIC-20		.38" (9.5mm)	.52" (13.2mm)
CT116	SOIC-24		.38" (9.5mm)	.62" (15.7mm)
CT118	SOIC-28		.38" (9.5mm)	.72" (18.2mm)
CT227	N/A		.44" (11.1mm)	1.13" (28.7mm)
CT504	SOIC-8		.20" (5.1mm)	.18" (4.5mm)
CT509	N/A		.20" (5.1mm)	.34" (8.6mm)
CT510	SOIC-14, 16		.20" (5.1mm)	.41" (10.4mm)
CT711	SOMC-16		.27" (6.9mm)	.45" (11.4mm)
CT919	SOJ-28		.34" (8.6mm)	.74" (18.8mm)

CROWN® Quad SMD Tips

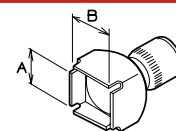

CT0808	N/A		.31" (7.9mm)	.31" (7.9mm)
CT0814	PLCC-18		.34" (8.6mm)	.54" (13.6mm)
CT1010	PLCC-20		.40" (10.2mm)	.40" (10.2mm)
CT1313	PLCC-28		.50" (12.7mm)	.50" (12.7mm)
CT1315	PLCC-32		.50" (12.7mm)	.60" (15.2mm)
CT1515	TQFP-100		.60" (15.2mm)	.60" (15.2mm)
CT1616	44-QFP		.64" (16.3mm)	.64" (16.3mm)
CT1723	64/80-QFP		.68" (17.3mm)	.92" (23.2mm)
CT1818	PLCC-44		.70" (17.8mm)	.70" (17.8mm)
CT2020	PLCC-52		.81" (20.6mm)	.81" (20.6mm)
CT2626	PLCC-68	1.00" (25.4mm)	1.00" (25.4mm)	
CT3131	PLCC-84	1.20" (30.5mm)	1.20" (30.5mm)	
CT3434	N/A	1.30" (33.5mm)	1.30" (33.5mm)	



DESOLDERING

Stations pgs 31 - 32
Portables page 33
Vacuum Power pgs 34 - 35
Replacement Tips pgs 36 - 37



Edsyn invented the industry's first patented desoldering hand tool known as the Soldapull®. This spring-loaded, hand-held vacuum device launched an industry revolution that continues to this day.

Once again, Edsyn engineers have created a unique desoldering solution - the ZD500DX - a deluxe hot tip desoldering station that redefines the quality standard. You can see and feel the quality from the moment you first pick up this ergonomic hand tool.

Manufactured at its factory in Van Nuys, California and backed by an 18 month warranty - Edsyn sets a performance standard that the competition can only try to match.

ZD500DX



Features





- A self-contained and high performance vacuum desoldering station ideal for heavy duty applications that require maximum heat transfer
- Powerful 70W high output PTC heating element makes heavy multi-layer boards easy to desolder
- Adjustable and ergonomic hand tool design offers four comfortable working angles
- Easy to maintain and calibrate with external calibration feature
- 18 month warranty & ESD safe

Contents

- | | |
|---------|--|
| ZD500DX | Self-Contained deluxe hot tip desoldering station includes HT500-2 hand tool with ZD13 tip |
| SH232 | Sponge holder with RS199 cleaning sponge |

Accessory Kit

- | | |
|---------|--|
| WT623 | Tip wrench, dual open end, 1/4" & 3/4" |
| WT619 | Tip wrench, for retaining sleeve |
| WP556 | WIGAPRY® mini screwdriver and calibration aid tool |
| CS468 | Tip cleaning shaft for desoldering tips |
| CS468-1 | Tip cleaning shaft for small desoldering tips |
| AN112 | Anti-Seize compound |
| OL111 | O-Ring lube |
| MS229 | 1 pc. mica sheet for HT500-2 |
| AF629 | 1 pc. felt filter for AF110 |
| AF625 | 1 pc. felt filter for HT500 |
| AF040 | 1 pc. foam filter for AF110 |

Models & Specifications	ZD500DX	ZD500DX-230	ZD500DX-230B	ZD500DX-230I
Power Requirements	120V, 60Hz	230V, 50Hz	230V, 50Hz	230V, 50Hz
Power Rating	95W - 200W	95W - 200W	95W - 200W	95W - 200W
Heater Rating	24V, 70W	24V, 70W	24V, 70W	24V, 70W
Plug	USA Standard 	European 	British 	USA Standard 
Weight	6 lbs (2.7 kg)			
Overall Dimension	5.0"W x 8.5"H x 9.0"D (127 mm x 216 mm x 229 mm)			
Temperature Range	400°F-800°F (205°C - 427°C)			
Temperature Regulation	±6°F (±3°C)			
Tip-to-Ground Voltage Leakage/Resistance	< 2mV / < 2 ohms			



ZD505V



Features





- Outstanding performance and cost-efficient station ideal for heavy duty applications that require maximum heat transfer (requires shop air 60-90 psi)
- Powerful 70W high output PTC element makes heavy multi-layer boards easy to desolder
- Adjustable and ergonomic hand tool design provides comfortable working angles
- Easy to maintain and calibrate with external calibration feature
- 18 month warranty & ESD safe

Contents

ZD505V	Shop air powered hot tip desoldering station includes PM100 vacuum generator and HT500 hand tool with ZD13 tip
SH230	Sponge holder includes RS199 cleaning sponge

Accessory Kit

WT623	Tip wrench, dual open end, 1/4" & 3/4"
WT619	Tip wrench, for retaining sleeve
WP556	WIGAPRY® mini screwdriver and calibration aid tool
CS468	Tip cleaning shaft for desoldering tips
CS468-1	Tip cleaning shaft for small desoldering tips
AN112	Anti-Seize compound
OL111	O-Ring lube
MS229	1 pc. mica sheet for HT500
AF629	1 pc. felt filter for AF110
AF625	1 pc. felt filter for HT500
AF040	1 pc. foam filter for AF110

Models & Specifications	ZD505V	ZD505V-230	ZD505V-230B	ZD505V-H9-230B
Power Requirements	120V, 60Hz	230V, 50Hz	230V, 50Hz	230V, 50Hz
Power Rating	20W - 150W	20W - 150W	20W - 150W	20W - 150W
Heater Rating	24V, 70W	24V, 70W	24V, 70W	24V, 70W
Plug	USA Standard 	European 	British 	British  Unit calibrated to 900°F
Weight	4.1 lbs (1.8 kg)			
Overall Dimension	5.0"W x 9.5"H x 9.0"D (127 mm x 241 mm x 229 mm)			
Temperature Range	400°F-800°F (205°C - 427°C)			
Temperature Regulation	±6°F (±3°C)			
Tip-to-Ground Voltage Leakage/Resistance	< 2mV / < 2 ohms			





DS017 Length: 13"(330mm) Wt: 3.5oz (99g)

"The Original" Deluxe SOLDAPULLT®

- Designed for heavy duty, high volume applications
- Easy one-hand loading and operation
- Integral cleaning shaft self-cleans no-stick PTFE tip



AS196 Length: 13"(330mm) Wt: 3.5oz (99g)

SILVERSTAT® SOLDAPULLT®

- The "Rolls Royce" of static safe desoldering hand tools
- Identical in size and performance to the DS017
- Engineered with conductive plating
- Especially designed for desoldering of static safe components



DS017LS Length: 13"(330mm) Wt: 3.5oz (99g)

Static Safe Deluxe SOLDAPULLT®

- Same as DS017 but molded from conductive plastic



PT109 Length: 12"(304mm) Wt: 2.5oz (71g)

SOLDAPULLT® III

- Smooth acting, light weight spring loaded tool
- Similar to the DS017 but with petite barrel for smaller hands
- Locking retractable shaft guide for portability and compact storage
- Integral cleaning shaft self-cleans no-stick PTFE tip



PT409 Length: 12"(304mm) Wt: 2.5oz (71g)

Static Safe SOLDAPULLT® III

- Same as PT109 but molded from conductive plastic



PT209 Length: 12"(304mm) Wt: 2.5oz (71g)

Micro Tip SOLDAPULLT® III

- Micro tip version of PT109 for heavily populated circuit boards and precision work
- Light weight petite barrel for smaller hands
- Locking retractable shaft guide for portability and compact storage
- Integral cleaning shaft self-cleans no-stick micro PTFE tip



US140 Length: 8.5"(216mm) Wt: 1.5oz (43g)

Universal SOLDAPULLT®

- Compact single-handed loading system
- Adjustable loading stroke to fit individual needs
- Loading and trigger release done with thumb



SS011 Length: 8"(203mm) Wt: 1.7oz (49g)

Static Safe SOLDAPULLT® Successor

- Static protection for sensitive devices
- Precision engineered metal barrel & static safe PTFE tip
- Simple single handed loading system



SS102 Length: 8"(203mm) Wt: 1.9oz (54g)

Micro Tip Static Safe SOLDAPULLT® Successor

- Micro tip version of SS011 for heavily populated boards and precision work
- Palm grip or finger touch trigger for easier handling
- Precision engineered metal barrel & static safe PTFE tip
- Simple single handed loading system



SS343 Length: 8.5"(216mm) Wt: 1.4oz (40g)

Static Safe Pico Tip Challenger SOLDAPULLT®

- New pointed pico tip for precision desoldering and high vacuum velocity for optimum performance
- Precision engineered metal barrel & static safe PTFE tip
- Simple single-handed loading system
- Static protection for sensitive devices



SS750LS Length: 8.5"(216mm) Wt: 1.2oz (34g)

Economical Static Safe Challenger SOLDAPULLT®

- Compact static safe barrel
- Quick change tiplet for no hassle maintenance
- Simple single-handed loading system



SS350 Length: 9"(229mm) Wt: 1.4oz (40g)

Static Safe Challenger SOLDAPULLT®

- Outstanding quality for the professional or hobbyist
- Precision engineered metal barrel & static safe PTFE tip
- Simple single-handed loading system
- Adjustable loading stroke to reduce hand strain



US340 Length: 8.5"(216mm) Wt: 1.5oz (43g)

Static Safe Universal SOLDAPULLT®

- Same as US140 but molded from conductive material
- Compact single-handed loading system
- Adjustable loading stroke to fit individual needs
- Loading and trigger release done with thumb

*See page 37 for a complete list of Replacement Tips and O-Rings





DS117



DS317



DS517

Common Features

- All models feature a self-cleaning automatic vacuum desoldering system that runs on continuous suction when trigger is pressed (requires external vacuum source - see VP171 or VS171A on next page for options)
- Convenient Auto- Vac® trigger on hand piece for quick action precise vacuum control
- Ideal for heavy duty work, large wiring, terminals, IC's and connectors
- Handle pulls off easily for easy cleaning and maintenance

Unique Features

- **DS117** is a heavy duty unit with a large clear plastic chamber to reduce clogging, hold more debris and visually determine when maintenance and cleaning is required. Power piston in holder cleans the tip whenever Auto- Vac® trigger is depressed
- **DS317** is a heavy duty unit especially designed with static-safe conductive plating for static sensitive components
- **DS517** is precision engineered metal barrel with static safe PTFE tip and has a slim aluminum anodized barrel for smaller hands

Contents

DS117

- | | |
|-------|-------------------------------------|
| PH177 | Power Head with SRT12 Standard Tip |
| PH178 | Power Head Holder |
| OA193 | O-Ring Set of 5 (for PH177 & PH178) |

DS317

- | | |
|-------|-------------------------------------|
| PH246 | Power Head with LS197 Standard Tip |
| PH184 | Power Head Holder |
| OA195 | O-Ring Set of 3 (for PH177 & PH246) |

DS517

- | | |
|-------|---------------------------------|
| PH358 | Power Head with LS561 Micro Tip |
| PH247 | Power Head Holder |
| OA197 | O-Ring Set of 3 |





VP171

Common Features

- No electrical hookup required
- Self regulating
- Stored vacuum provides instant vacuum response
- ESD-safe construction
- Requires clean and dry shop air:
60 - 90 psi/4.1 - 6.2 bar
- Quiet vacuum: 15 - 22 in. Hg/381- 559 mm
- Automatic shut-off mechanism



VS171A

Unique Features

- **VP171** has a large vacuum tank to support six separate desoldering applications
- **VS171A** has a vacuum tank to support one desoldering application



Typical set up for the VP171 ATMOSCOPE® vacuum generator with DS317 (can connect up to six desoldering tools)

Models & Specifications	VP171	VS171A
Dimensions	10" x 6.2" x 7.6"	8.3" x 4.1" x 6.8"
Weight	2.9 lb (1.3 kg)	1.4 b (.63 kg)



Heater Desoldering Tools and Stations

Part No.	Description
ZD500DX	SOLDAPULLT® Self-Contained Hot Tip Desoldering Station (includes all 230V models)
ZD505V	SOLDAPULLT® Hot Tip Desoldering Station (includes all 230V models)

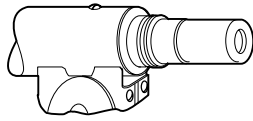

HT500 Heater

General Purpose Tip

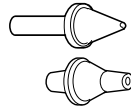



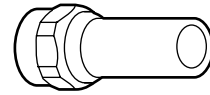



Funnel Tip

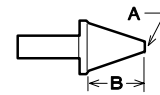





RS383 Retaining Sleeve

Iron-Plated General Purpose Tips



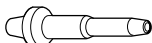

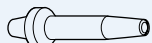
Part No.	Tip Image	Width A	Length B
ZD12		.03" (0.8mm)	.50" (12.7mm)
ZD13		.04" (1.0mm)	.50" (12.7mm)
ZD14		.06" (1.5mm)	.50" (12.7mm)
ZD18		.07" (1.8mm)	.50" (12.7mm)
ZD19		.12" (3.0mm)	.50" (12.7mm)

Iron-Plated Funnel Tips

ZD107		.02" (10.5mm)	.48" (12.2mm)
ZD111		.03" (0.8mm)	1.22" (31.0mm)
ZD112		.03" (0.8mm)	.48" (12.2mm)
ZD113		.04" (1.0mm)	.48" (12.2mm)
ZD115		.07" (1.8mm)	1.22" (31.0mm)
ZD118		.07" (1.8mm)	.48" (12.2mm)

Portable Replacement Tips and O-Rings

Soldapullt® Part No.	Tip Part No.	Tip Image	i.d.	L	Replacement O-Ring Part No.
AS196	LS197		.136" (3.4mm)	.53" (13.5mm)	ODS31
DS017	SRT12		.136" (3.4mm)	.53" (13.5mm)	ODS31
DS017LS	LS197		.136" (3.4mm)	.53" (13.5mm)	ODS31
DS117	SRT12		.136" (3.4mm)	.53" (13.5mm)	OA193 & ODS31
DS317	LS197		.136" (3.4mm)	.53" (13.5mm)	OA195 & ODS31
DS517	LS561		.098" (2.5mm)	.53" (13.5 mm)	OA197
PT109	SRT12		.136" (3.4mm)	.53" (13.5mm)	OSB32
PT209	MRT16		.098" (2.5mm)	.53" (13.5mm)	OSB32
PT409	LS197		.136" (3.4mm)	.53" (13.5mm)	OSB32
SS011	LS363A		.136" (3.4mm)	.53" (13.5mm)	OS130
SS102	LS364A		.098" (2.5mm)	.53" (13.5mm)	OS130
SS343	LS915		.070" (1.8mm)	.53" (13.5mm)	OS130
SS350	LS363		.136" (3.4mm)	.53" (13.5mm)	OS130
SS750LS	LS751		.107" (2.7mm)	.50" (12.7mm)	OS130
US140	SRT12		.136" (3.4mm)	.53" (13.5mm)	ODS31
US340	LS197		.136" (3.4mm)	.53" (13.5mm)	ODS31

Maintenance Tip: Use OL111 O-Ring lube for lubrication and longer tool life



SMT

Stations
Tips

pgs 39 - 41
pgs 42 - 47



Edsyn offers versatile rework solutions to your production and rework challenges. Using precise airflow & heat transfer you can simultaneously remove and rework electronic components up to 208 QFP.

Edsyn's SMT solutions are perfect for micro rework applications as well and work with pinpoint accuracy and temperature control. Each station offers unique versatility and outstanding performance and are designed for high performance in a small footprint.

Manufactured at its factory in Van Nuys, California and backed by an 18 month warranty - Edsyn sets a performance standard that the competition can only try to match.

971HA



Features





- Versatile and outstanding performance using hot air or contact rework techniques from one handle (requires shop air or nitrogen, 20-80 psi)
- Adjustable airflow and automatic shut-off valve when hand piece is placed in holder
- Easy to maintain and calibrate with external calibration feature
- Uses a wide variety of nozzle sizes
- ESD Safe
- 18 month warranty

Contents

971HA	SMT hot air station includes LT428 tip
PD533	Tool pod
PR570	Flow regulator and meter
SH230	Sponge holder includes RS199 cleaning sponge, RS243 leveling pad, LN230 sponge liner

Accessory Kit

WT620	Tip wrench, 1/4" socket
WT624	Tip wrench, dual open end, 1/4" & 5/16"
ST706	SMD tool to lift off SMD's
RB641	Shim blade replacement
WS630	SMD pull wire with low static spool
AN112	Anti-Seize compound
WP556	WIGAPRY [®] mini screwdriver and calibration aid tool

Models & Specifications	971HA	971DH-230	971HA-230I	971DH-230B
Power Requirements	120V, 60Hz	230V, 50Hz	230V, 50Hz	230V, 50Hz
Power Rating	15W - 220W	18W - 160W	125W	18W - 160W
Heater Rating	120V, 95W	24V, 53W	230V, 95W	24V, 53W
Plug	USA Standard 	European 	USA Standard 	British 
Weight	3.3 lbs (1.5 kg)	5.5 lbs (2.5 kg)	3.3 lbs (1.5 kg)	5.5 lbs (1.5 kg)
Overall Dimension	4.1"W x 9.7"H x 10"D (104 mm x 246 mm x 254 mm)			
Temperature Range	400°F - 800°F (205°C - 427°C)			
Temperature Regulation	±6°F (±3°C)			
Tip-to-Ground Voltage Leakage/Resistance	< 2mV / < 2 ohms			



1036



Features



- Self-contained hot air station with a built-in air source specifically designed to navigate densely populated areas with pinpoint accuracy
- Provides precise application of hot air for components with up to 84 pins (208 QFP)
- Adjustable airflow
- Uses a wide variety of nozzle sizes and expands to include optional soldering iron
- ESD safe
- 18 month warranty

Contents

- | | |
|-------|--|
| 1036 | Self-Contained SMT hot air station with FA069 hot air handle with LT428 tip |
| PD525 | Tool pod |
| SH230 | Sponge holder includes RS199 cleaning sponge, RS243 leveling pad, LN230 sponge liner |

Accessory Kit

- | | |
|-------|---|
| WT620 | Tip wrench, 1/4" socket |
| WT624 | Tip wrench, dual open end, 1/4" & 5/16" |
| ST706 | SMD tool to lift off SMD's |
| RB641 | Shim blade replacement |
| WS630 | SMD pull wire with low static spool |
| AN112 | Anti-Seize compound |

Models & Specifications	1036	1036-230B
Power Requirements	120V, 60Hz	230V, 50Hz
Power Rating	150W	125W
Heater Rating	120V, 95W	230V, 95W
Plug	USA Standard 	British 
Weight	4.3 lbs (1.9 kg)	
Overall Dimension	5.2"W x 8.5"H x 10"D (132 mm x 216 mm x 254 mm)	
Temperature Range	400°F-800°F (205°C - 427°C)	
Temperature Regulation	±6°F (±3°C)	
Tip-to-Ground Voltage & Leakage/Resistance	< 2mV / < 2 ohms	



1036DX



Features



- A deluxe self-contained hot air station with versatility to adjust to either hot air or contact soldering from the same handle
- Use to rework Gullwings, J-Leads, PLCC's and small outline components
- Small hand tool is light and easy to use
- Uses a wide variety of nozzle sizes and general purpose soldering tips
- Small vacuum pick up tool included
- ESD safe
- 18 month warranty

Contents

1036DX	Self-Contained Deluxe SMT hot air station with LU26 hot air tip and LT375 soldering tip
PD533	Tool pod for hot air tool
LP250	Pick-Up tool for SMD components
PD532	Tool holder for pick-up tool
SH230	Sponge holder includes RS199 cleaning sponge, RS243 leveling pad, LN230 sponge liner

Accessory Kit

WT620	Tip wrench, 1/4" socket
WT623	Tip wrench, dual open end, 1/4" & 3/4"
WT624	Tip wrench, dual open end, 1/4" & 5/16"
ST800	SMD helper (includes RB642 shim blade and WS630 pull wire)
WP556	WIGAPRY [®] mini screwdriver and calibration aid tool

Models & Specifications	1036DX	1036DX-230B	1036DX/B-230
Power Requirements	120V, 60Hz	230V, 50Hz	230V, 50Hz
Power Rating	85W - 230W	125W	18W - 160W
Heater Rating	24V, 53W	230V, 95W	24V, 53W
Plug	USA Standard 	British 	European 
Weight	5.0 lbs (2.3 kg)	6.5 lbs (2.9 kg)	4.3 lbs (1.9 kg)
Overall Dimension	5.2"W x 8.5"H x 10"D (104 mm x 216 mm x 254 mm)		
Temperature Range	400°F - 800°F (205°C - 427°C)		
Temperature Regulation	±6°F (±3°C)		
Tip-to-Ground Voltage & Leakage/Resistance	< 2mV / < 2 ohms		



Internal Threaded Heater Hot Air Tools and Stations

Part No.	Description
971HA	SMT Hot Air Station
1036	Self-Contained SMT Hot Air Station (with FAO69 Hot Air Tool)

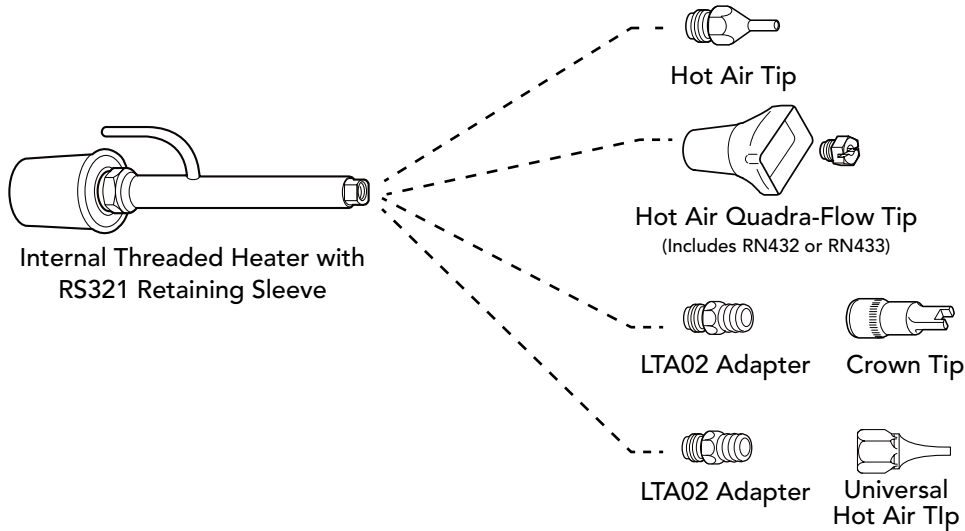

Internal Threaded Heater Hot Air Tools and Stations

Part No.	Description
1036DX	Self-Contained SMT Deluxe Hot Air Station

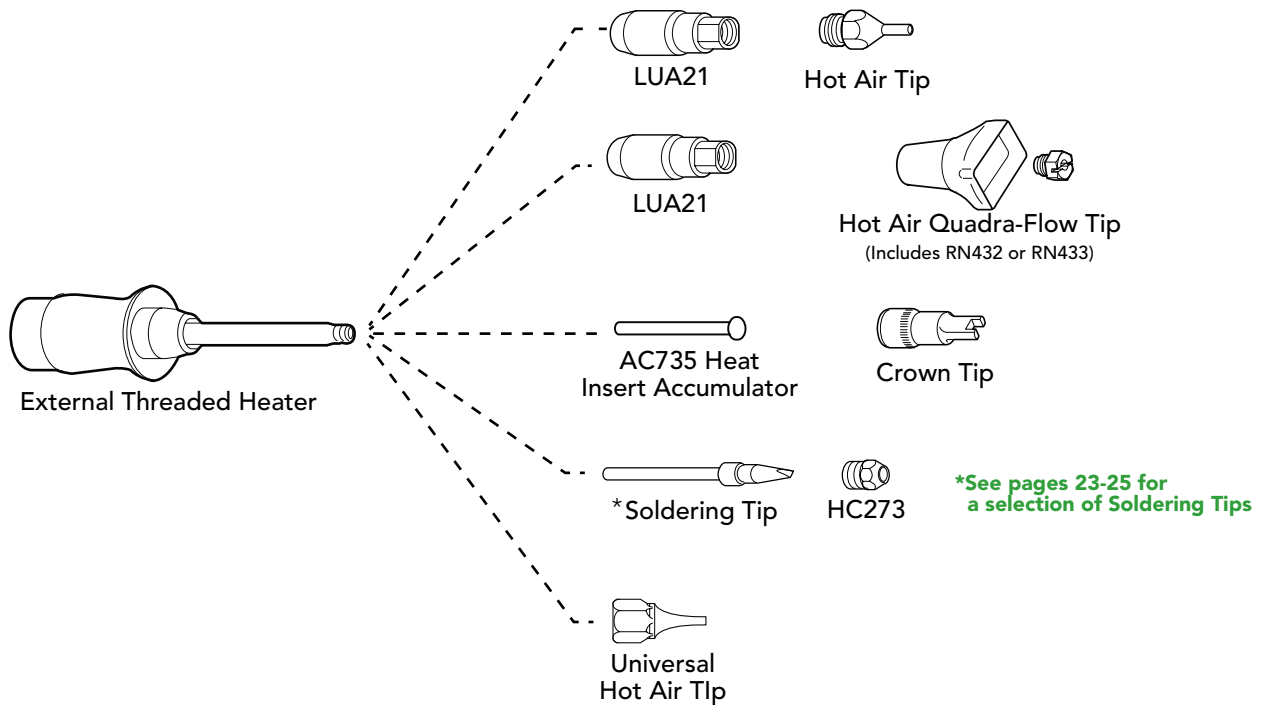



Single Nozzle Tips

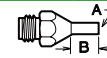

Part No.	Tip Image	Hole Dia. A	Length B
LT427		.02" (0.5mm)	.38" (95mm)
LT428		.06" (1.5mm)	.25" (6.4mm)
LT432		.04" (1.0mm)	.06" (1.5mm)
LT514		.10" (2.5mm)	.25" (6.4mm)

Fan Tips

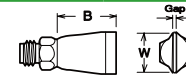

Part No.	Tip Image	Gap	Width W	Length B
LT426		.02" (0.5mm)	.30" (7.6mm)	.17" (4.3mm)
LT434		.02" (0.5mm)	.46" (11.7mm)	.23" (5.8mm)
LT435		.02" (0.5mm)	.59" (15.0mm)	.35" (8.9mm)
LT436		.02" (0.5mm)	.65" (16.5mm)	.43" (10.9mm)

Dual Flow Tips

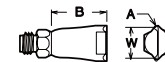

Part No.	Tip Image	Hole Dia. A	Width W	Length B
LT526		.03" (0.8mm)	.12" (3.0mm)	.30" (7.6mm)
LT534		.05" (1.3mm)	.20" (5.1mm)	.46" (11.7mm)
LT535		.05" (1.3mm)	.28" (7.1mm)	.59" (15.0mm)
LT536		.05" (1.3mm)	.35" (8.9mm)	.65" (16.5mm)
LT537		.05" (1.3mm)	.44" (11.2mm)	.80" (20.4mm)

Curl/Bent Tips

Part No.	Tip Image	Hole Dia.	Nozzle Length
LT510		.02" (0.5mm)	.65" (16.5mm)
LT511		.06" (1.5mm)	.65" (16.5mm)
LT512		.07" (1.8mm)	.90" (22.9mm)
LT513		.10" (2.5mm)	.90" (22.9mm)
LT571		.04" (1.0mm)	1.10" (27.9mm)
LT572		.04" (1.0mm)	MAX. GAP WIDTH 1.25" (31.8mm)



Universal Hot Air Tips

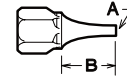

Part No.	Tip Image	Hole Dia A	Length B
LU25		.03" (6.4mm)	.25" (6.4mm)
LU26		.04" (6.4mm)	.25" (6.4mm)
LU27		.06" (6.4mm)	.25" (6.4mm)
LU28		.09" (6.4mm)	.25" (6.4mm)
LU29		.05" (7.5mm)	.29" (7.5mm)
LU30		.05" (17.8mm)	.70" (17.8mm)
LU571		.04" (27.9mm)	1.10" (27.9mm)
LU572		.04" (1.0mm)	MAX. GAP WIDTH 1.25" (31.8mm)

SMD Quadra Flow Hot Air Tips

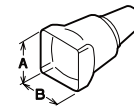

Part No.	Package	Tip Image	Width A	Length B
LT447	SO-8		.16" (4.0mm)	.20" (5.1mm)
LT448	SO-14		.21" (5.3mm)	.35" (8.9mm)
LT449	SO-16		.26" (6.6mm)	.41" (10.4mm)
LT450	SO-16L		.42" (10.7mm)	.43" (10.9mm)
LT451	SO-18L		.44" (11.2mm)	.48" (12.2mm)
LT452	SO-20L		.38" (9.5mm)	.52" (13.2mm)
LT454	SO-28L		.43" (10.9mm)	.73" (18.6mm)
LT455	PLCC-20		.40" (10.2mm)	.40" (10.2mm)
LT456	PLCC-28		.50" (12.7mm)	.50" (12.7mm)
LT458	PLCC-44 LCCC-44		.70" (17.8mm)	.70" (17.8mm)



SMD Quadra Flow Hot Air Tips

Part No.	Package	Tip Image	Width A	Length B
LT459	PLCC-52 QFP-100		.80" (20.3mm)	.80" (20.3mm)
LT459-1			.80" (20.3mm)	.80" (20.3mm)
LT460	PLCC-68		1.0" (25.4mm)	1.0" (25.4mm)
LT462	PLCC-18		.34" (8.6mm)	.55" (14.0mm)
LT463	QFP-44		.60" (15.2mm)	.60" (15.2mm)
LT468	QFP-100		.66" (16.8mm)	.90" (22.9mm)
LT477			.75" (19mm)	1.0" (25.4mm)
LT478	LCCC-18R		.32" (8.1mm)	.45" (11.4mm)
LT482	LCCC-32R		.47" (11.9mm)	.58" (14.7mm)
LT484	SOJ-20		.40" (10.2mm)	.79" (20.1mm)
LT485			.52" (13.2mm)	.64" (16.3mm)
LT486	PLCC-28R		.40" (10.2mm)	.60" (15.2mm)
LT488	LCCC-84 QFP-144		1.17" (29.7mm)	1.17" (29.7mm)
LT493	SOJ-32		.48" (12.2mm)	.85" (21.6mm)
LT494	SOJ-40		.45" (11.4mm)	1.05" (26.7mm)
LT1629	SOP-44		.63" (16.0mm)	1.14" (29.0mm)
LT1824	QFP-100		.70" (17.8mm)	.94" (23.9mm)
LT2228			.85" (21.6mm)	1.1" (27.9mm)





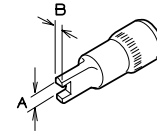

CROWN® Series Contact Surface Mount Tips

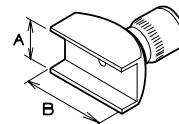

Part No.	Package	Tip Image	Width A	Length B
CT12	SOT-23		.07" (1.8mm)	.10" (2.5mm)
CT21	805		.09" (2.3mm)	.06" (1.5mm)
CT25	SOT-89		.10" (2.5mm)	.21" (5.3mm)
CT31	1206, 1210		.14" (3.5mm)	.07" (1.8mm)
CT42	1808, 1812		.19" (4.8mm)	.09" (2.3mm)
CT52	N/A		.20" (5.1mm)	.10" (2.5mm)
CT53	N/A		.23" (5.8mm)	.14" (3.5mm)

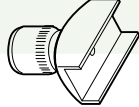
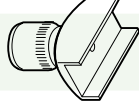
CROWN® Tunnel SMD Tips

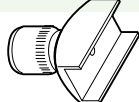

CT110	SOIC-18		.38" (9.5mm)	.40" (10.2mm)
CT113	SOIC-20		.38" (9.5mm)	.52" (13.2mm)
CT116	SOIC-24		.38" (9.5mm)	.62" (15.7mm)
CT118	SOIC-28		.38" (9.5mm)	.72" (18.2mm)
CT227	N/A		.45" (11.4mm)	1.08" (27.5mm)
CT504	SOIC-8		.20" (5.1mm)	.18" (4.5mm)



CROWN® Tunnel SMD Tips

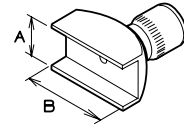

Part No.	Package	Tip Image	Width A	Length B
CT509	N/A		.20" (5.1mm)	.35" (8.9mm)
CT510	SOIC-14, 16		.20" (5.1mm)	.41" (10.4mm)
CT711	SOMC-16		.27" (6.9mm)	.45" (11.4mm)
CT919	SOJ-28		.34" (8.6mm)	.74" (18.9mm)

CROWN® Quad SMD Tips

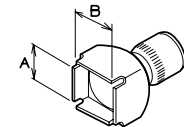

CT0808	N/A		.31" (7.9mm)	.31" (7.9mm)
CT0814	PLCC-18		.34" (8.6mm)	.54" (13.6mm)
CT1010	PLCC-20		.40" (10.2mm)	.40" (10.2mm)
CT1313	PLCC-28		.50" (12.7mm)	.50" (12.7mm)
CT1315	PLCC-32		.50" (12.7mm)	.60" (15.4mm)
CT1515	TQFP-100		.60" (15.2mm)	.60" (15.2mm)
CT1616	44-QFP		.64" (16.3mm)	.64" (16.3mm)
CT1723	64/80-QFP		.68" (17.3mm)	.92" (23.2mm)
CT1818	PLCC-44		.70" (17.8mm)	.70" (17.8mm)
CT2020	PLCC-52		.81" (20.6mm)	.81" (20.6mm)
CT2626	PLCC-68		1.0" (25.4mm)	1.0" (25.4mm)
CT3131	PLCC-84		1.20" (30.5mm)	1.20" (30.5mm)
CT3434	N/A		1.30" (33.5mm)	1.30" (33.5mm)



MULTI-TASKING

Stations
Tips

pgs 49 - 52
pgs 53 - 63



One day the telephone rang. A customer needed to integrate a combination of Edsyn tools for a unique site preparation problem. The result of that conversation became the TSX70.

This highly effective SMT reflow workstation has remarkable "on-demand" vacuum features while providing clean work areas in limited spaces for complex packages and fine pitch devices. As an added bonus, technicians with even novice skills can now consistently deliver superior professional results.

Being a leader means listening to customers and fulfilling their needs - time and time again. It is a pattern we have grown accustomed to since Edsyn patented its first tool nearly 50 years ago.

TSX70



Features



- This ground-breaking technology introduces the most effective and innovative site preparation system for BGAs, PLCC's, QFP's and other fine pitch devices using hot air reflow and desoldering functions from one handpiece
- Nitrogen capable to reduce oxidation and bridging
- Dual controls for hot gas and tip temperatures to produce even heating of board
- Recommended and utilized by major manufacturers
- International models available
- ESD safe
- 18 month warranty

Contents

- TSX70 SMT reflow vacuum workstation includes TSX70-1 hand piece with TSX713 tip
- SH232 Sponge holder with RS199 cleaning sponge

Accessory Kit

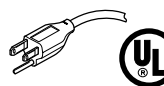
- WT623 Tip wrench, dual open end, 1/4" & 3/4"
- WT624 Tip wrench, dual open end, 1/4" & 5/16"
- WP556 WIGAPRY® mini screwdriver and calibration aid tool
- MS229 1 pc. mica sheet for HT500
- AF629 1 pc. felt filter for AF110
- AF625 1 pc. felt filter for HT500
- AF624 1 pc. foam filter for AF110
- CSX70 Maintenance tool with cleaning shaft
- OL111 O-Ring lube for trigger housing in TSX70-1

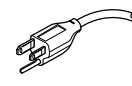
Models & Specifications	TSX70	TSX70-230B	TSX70-230I
Power Requirements	120V, 60Hz	230V, 50Hz	230V, 50Hz
Power Rating	30W - 330W	39W - 330W	39W - 330W
Heater Rating (hot air)	24V, 45W	24V, 45W	24V, 45W
Heater Rating (desoldering)	24V, 70W	24V, 70W	24V, 70W
Plug	USA Standard 	British 	USA Standard 
Weight	7.1 lbs (3.1 kg)	7.1 lbs (3.1 kg)	7.1 lbs (3.1 kg)
Overall Dimension	5.8"W x 10"H x 8.8"D (147 mm x 254 mm x 224 mm)		
Temperature Range	400°F - 800°F (205°C - 427°C)		
Temperature Regulation	±6°F (±3°C)		
Tip-to-Ground Voltage & Leakage/Resistance	< 2mV / < 2 ohms		



1072



Features



- Ultimate hot air and soldering rework center with dual accurate linear temperature controlled handpieces (requires shop air or nitrogen, 20 - 80 psi)
- Direct tip-to-heater configuration delivers more stable, accurate and reliable temperatures at the tip
- External calibration feature allows easy access for precision adjustments
- Innovative handle design makes tip change faster & easier
- Accepts a wide variety of tips and nozzles
- International models available
- ESD safe
- 18 month warranty

Contents

- | | |
|-------|--|
| 1072 | Multi-tasking dual hot air and soldering station includes LT375 and LT428 tips |
| PD528 | Tool pod for soldering tool |
| PD533 | Tool pod for Hot air tool |
| SH230 | Sponge holder includes RS199 cleaning sponge, RS243 leveling pad, LN230 sponge liner |
| PR570 | Flow regulator and meter |

Accessory Kit

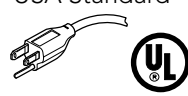
- | | |
|-------|--|
| WP556 | WIGAPRY® mini screwdriver and calibration aid tool |
| WT620 | Tip wrench, 1/4" socket |
| WT624 | Tip wrench, dual open end, 1/4" & 5/16" |
| ST706 | Tool to lift off SMD |
| RB641 | SMD Shim blade replacement |
| WS630 | SMD Pull wire replacement |
| AN112 | Anti-Seize compound |

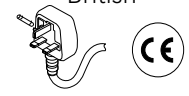
Models & Specifications	1072	1072DX-230	1072DX-230B
Power Requirements	120V, 60Hz	230V, 50Hz	230V, 50Hz
Power Rating	30W - 440W	90W-215W	90W-215W
Heater Rating	120V, 95W	24V, 53W	24V, 53W
Plug	USA Standard 	European 	British 
Weight	4.7 lbs (2.1 kg)	7.0 lbs (3.2 kg)	7.0 lbs (3.2 kg)
Overall Dimension	7.7"W x 9.9"H x 11.1"D (195 mm x 251 mm x 282 mm)		
Temperature Range	400°F-800°F (205°C - 427°C)		
Temperature Regulation	±6°F (±3°C)		
Tip-to-Ground Voltage & Leakage/Resistance	< 2mV / < 2 ohms		



ZD905V



Features



- A simple, economical and easy soldering and desoldering rework center with dual independent temperature controlled handpieces (requires shop air, 60-90 psi)
- Delivers high performance in a small footprint
- External calibration feature allows easy access for precision adjustments
- Accepts a wide variety of tips
- International models available
- ESD safe
- 18 month warranty

Contents

- ZD905V Hot tip soldering and desoldering system includes:
- HT500 Hot tip desoldering hand tool with ZD13 tip
 - LST11 Soldering tool with LT375 tip

Accessory Kit

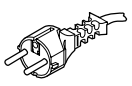
- WT623 Tip wrench, dual open end, 1/4" & 3/4"
- WT619 Tip wrench for removing retaining sleeve
- CS468 Tip cleaning shaft for desoldering tips
- CS468-1 Tip cleaning shaft for small desoldering tips
- AN112 Anti-Seize compound
- OL111 O-Ring lube
- MS229 1 pc. mica sheet for HT500
- AF629 1 pc. felt filter for AF110
- AF625 1 pc. felt filter for HT500
- AF040 1 pc. foam filter for AF110
- WP556 WIGAPRY® mini screwdriver and calibration aid tool

Models & Specifications	ZD905V	ZD905V-230	ZD905V-230B
Power Requirements	120V, 60Hz	230V, 50Hz	230V, 50Hz
Power Rating	38W - 310W	38W - 310W	38W - 310W
Heater Rating (Hot tip desoldering hand tool)	24V, 70W	24V, 70W	24V, 70W
Heater Rating (Soldering tool)	24V, 53W	24V, 53W	24V, 53W
Plug	USA Standard 	European 	British 
Weight	5.4 lbs (2.4 kg)	7.1 lbs (3.1 kg)	7.1 lbs (3.1 kg)
Overall Dimension	5.5"W x 9"H x 9.5"D (140 mm x 229 mm x 241 mm)		
Temperature Range	400°F - 800°F (205°C - 427°C)		
Temperature Regulation	±6°F (±3°C)		
Tip-to-Ground Voltage & Leakage/Resistance	< 2mV / < 2 ohms		



ZD906



Features



- The ideal rework center for technicians needing soldering, desoldering and hot air capabilities in one small unit (shop air required for 2 air inputs, 60-90 psi)
- Powerful heating elements deliver high performance and are well suited for multi-layer boards and thick heat-sinks
- External calibration feature allows easy access for precision adjustments
- International models available
- ESD safe
- 18 month warranty

Contents

- | | |
|---------|---|
| ZD906 | Shop air powered rework system includes: |
| - HT500 | Hot tip desoldering hand tool with ZD13 tip |
| - FA069 | Hot air tool with LT428 tip |
| - LST11 | Soldering tool with LT375 tip |

Accessory Kit

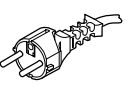
- | | |
|---------|--|
| WT623 | Tip wrench, dual open end, 1/4" & 3/4" |
| WT619 | Tip wrench for retaining sleeve |
| WP556 | WIGAPRY® mini screwdriver and calibration aid tool |
| WT620 | Tip wrench, 1/4" socket |
| CS468 | Tip cleaning shaft for desoldering tips |
| CS468-1 | Tip cleaning shaft for small desoldering tips |
| AN122 | Anti-Seize compound |
| OL111 | O-Ring lube |
| MS229 | 1 pc. mica sheet for HT500 |
| AF629 | 1 pc. felt filter for AF110 |
| AF625 | 1 pc. felt filter for HT500 |
| AF040 | 1 pc. foam filter for AF110 |

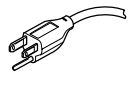
Models & Specifications	ZD906	ZD906-230	ZD906-230B	ZD906-230I
Power Requirements	120V, 60Hz	230V, 50/60Hz	230V, 50/60Hz	230V, 50/60Hz
Power Rating	38W - 380W	39W - 330W	39W - 330W	39W - 330W
Heater Rating (Hot tip desoldering hand tool)	24V, 70W	24V, 70W	24V, 70W	24V, 70W
Heater Rating (Soldering tool)	24V, 53W	24V, 53W	24V, 53W	24V, 53W
Heater Rating (SMD Hot air tool)	120V, 95W	230V, 95W	230V, 95W	230V, 95W
Plug	USA Standard 	European 	British 	USA Standard 
Weight	6.7 lbs (3 kg)	7.4 lbs (3.3 kg)	7.4 lbs (3.3 kg)	7.4 lbs (3.3 kg)
Overall Dimension	7.5"W x 9"H x 9.5"D (197 mm x 229 mm x 241 mm)			
Temperature Range	400°F - 800°F (205°C - 427°C)			
Temperature Regulation	±6°F (±3°C)			
Tip-to-Ground Voltage Leakage/Resistance	< 2mV / < 2 ohms			



ZD906 Multi-Tasking Station Tip Set ups

ZD906 Set Ups

ZD906 Shop Air Powered Rework Station

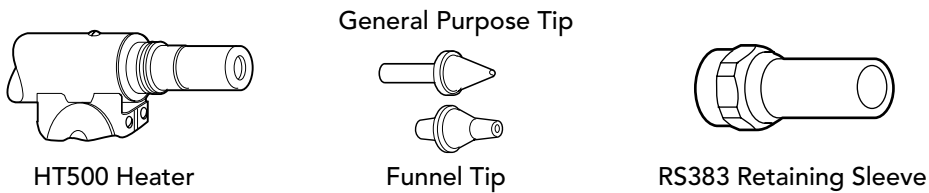
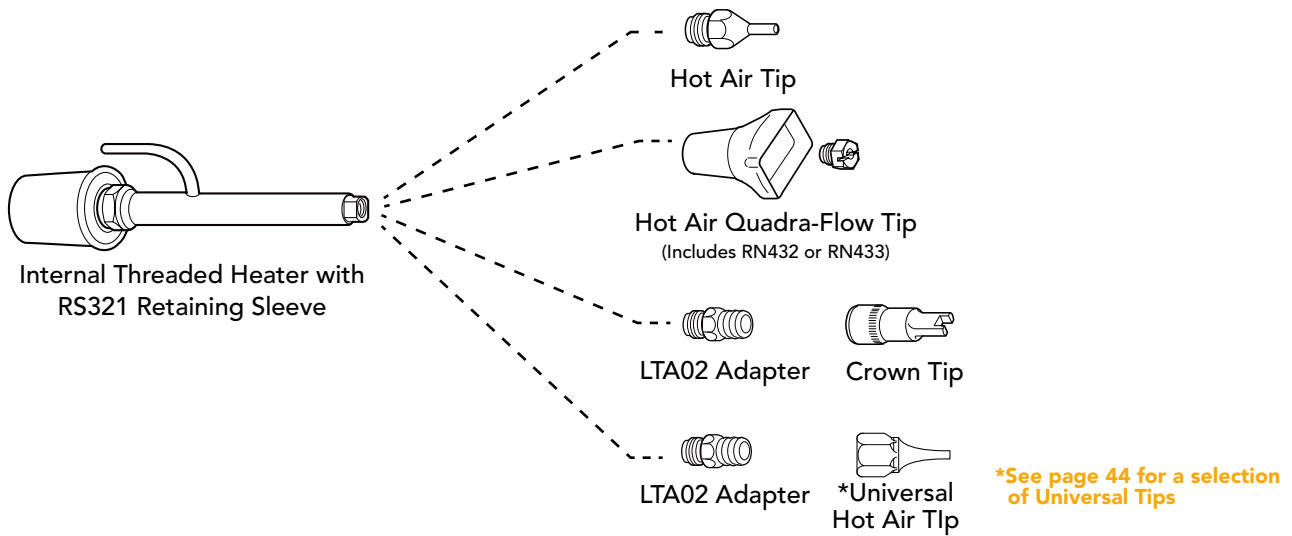
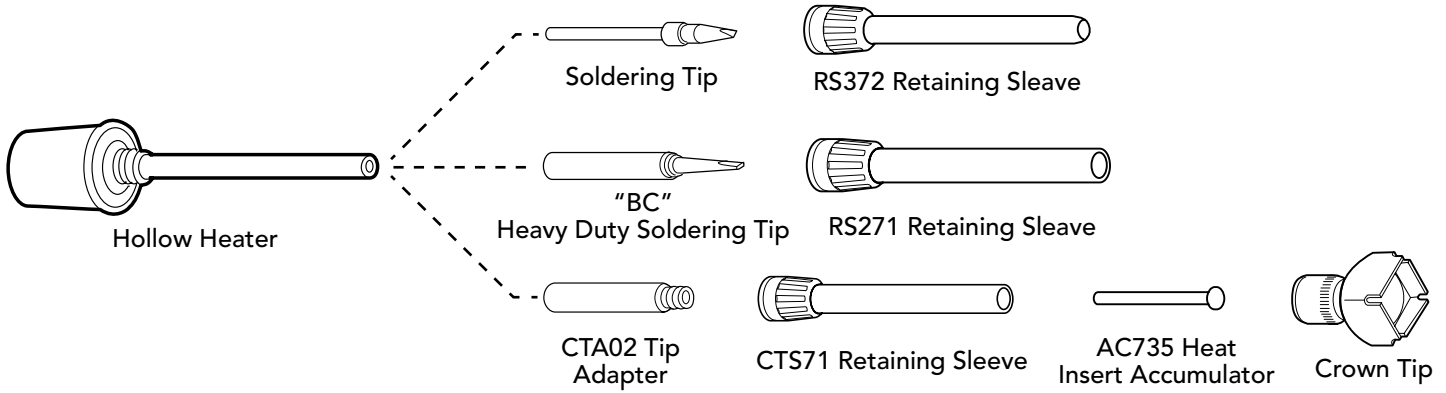

ZD905V Set Ups

ZD905V Hot Tip Desoldering and Soldering Station

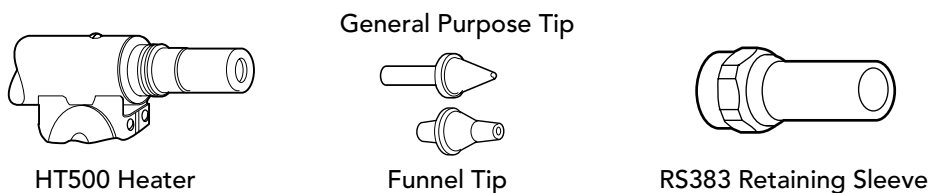
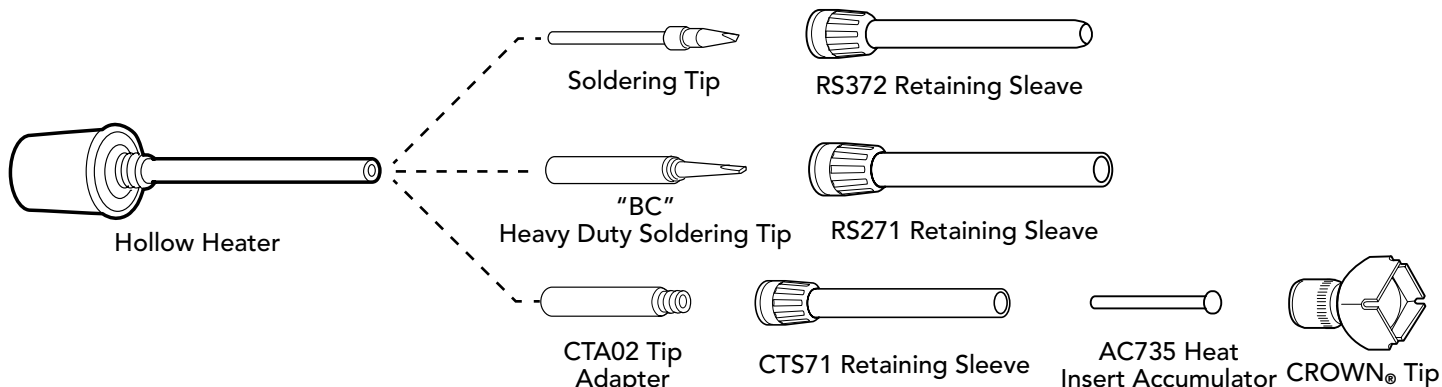

1072 Set Ups

1072 Hot Air and Soldering Rework Center

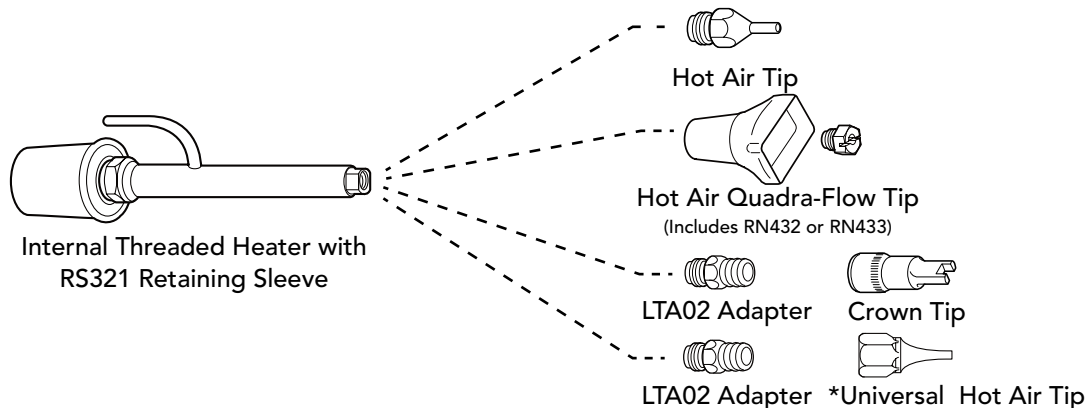
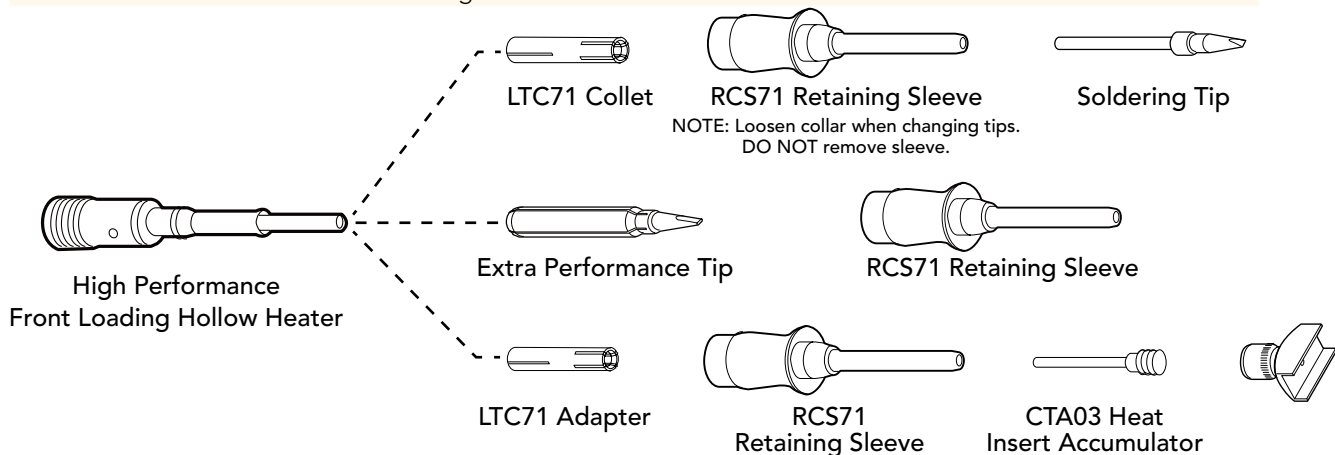

*See page 44 for a selection of Universal Tips



General Purpose Spade Tips

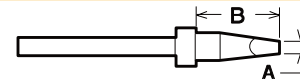

Part No.	Tip Image	Width A	Length B
LT375		.06" (1.5mm)	.48" (12.2mm)
LT376		.12" (3.0mm)	.48" (12.2mm)
LT394		.07" (1.8mm)	.93" (23.6mm)
LT395		.09" (2.3mm)	.74" (18.8mm)
LT431		.07" (1.8mm)	.74" (18.8mm)
LT444		.04" (1.0mm)	.78" (19.8mm)

General Purpose Conical Tips

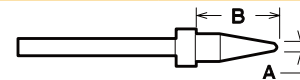

LT374		.03" (0.8mm)	.48" (12.2mm)
LT382		.02" (1.5mm)	.62" (15.8mm)
LT429		.02" (0.5mm)	.74" (18.8mm)

General Purpose Angled Conical Tip

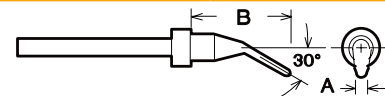

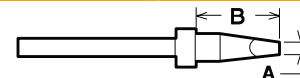

LT429-1		.02" (0.5mm)	.74" (18.8mm)
---------	--	--------------	---------------

High Temperature Rated Spade Tips



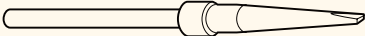

LT371LF		.03" (0.8mm)	.05" (14.0mm)
LT375LF		.06" (1.5mm)	.48" (12.2mm)
LT376LF		.12" (3.0mm)	.48" (12.2mm)
LT394LF		.07" (1.8mm)	.93" (23.6mm)
LT395LF		.09" (2.3mm)	.74" (18.8mm)
LT424LF		.06" (1.5mm)	.74" (18.8mm)
LT425LF		.05" (1.3mm)	.93" (23.6mm)



Part No.	Tip Image	Width A	Length B
LT431LF		.07" (1.8mm)	.74" (18.8mm)
LT444LF		.04" (1.0mm)	.78" (9.8mm)

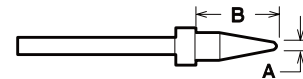

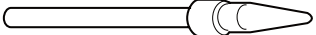
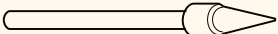
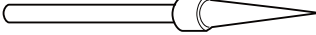
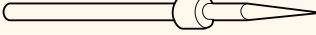
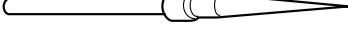
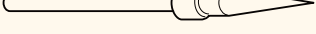
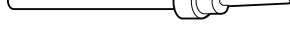
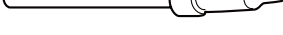



High Temperature Rated Conical Tips

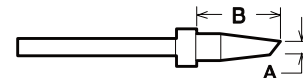

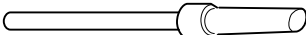
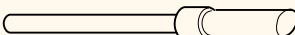
LT374LF		.03" (0.8mm)	.48" (12.2mm)
LT380LF		.02" (0.5mm)	.32" (8.1mm)
LT382LF		.02" (0.5mm)	.62" (15.8mm)
LT383LF		.02" (0.5mm)	.72" (18.3mm)
LT392LF		.01" (0.3mm)	1.13" (28.8mm)
LT429LF		.02" (0.5mm)	.74" (18.8mm)
LT439LF		.03" (0.8mm)	.50" (12.7mm)
LT446LF		.03" (0.8mm)	.48" (12.2mm)
LT603LF		.02" (0.5mm)	.69" (17.5mm)

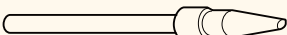
High Temperature Rated Angle Face Tips

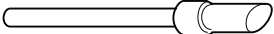

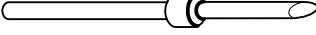
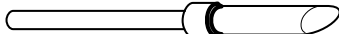
LT298LF		.12" (3.1mm)	.59" (15.0mm)
LT299LF		.16" (4.0mm)	.59" (15.0mm)
LT373LF		.09" (2.3mm)	.59" (15.0mm)
LT387LF		.06" (1.5mm)	.48" (12.2mm)
LT393LF		.06" (1.5mm)	.94" (23.9mm)
LT398LF		.12" (3.0mm)	.59" (15.0mm)
LT399LF		.16" (4.0mm)	.59" (15.0mm)
LT430LF		.06" (1.5mm)	.74" (18.8mm)
LT433LF		.04" (1.2mm)	.69" (17.5mm)
LT443LF		.097" (2.5mm)	.69" (17.5mm)



High Temperature Rated Angled Spade Tip

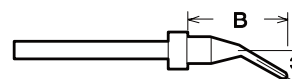

Part No.	Tip Image	Width A	Length B
LT444-1LF		.04" (1.0mm)	.78" (9.8mm)

High Temperature Rated Angled Conical Tips

LT392-1LF		.01" (0.3mm)	1.13" (28.8mm)
LT439-1LF		.03" (0.8mm)	.50" (12.7mm)
LT602-1LF		.02" (0.5mm)	.44" (11.2mm)

High Temperature Rated Mini Flow Rework Tips

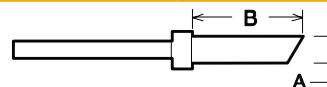

LT396LF		.13" (3.3mm)	.69" (17.5mm)
---------	--	--------------	---------------

High Temperature Rated Heavy Duty Spade Tips



HS106BC		.18" (4.6mm)	.45" (11.4mm)
HS106BC-5		.058" x .297" notch .18" (4.6mm)	.45" (11.4mm)
LT336BC		.07" (1.8mm)	.74" (18.8mm)
LT337BC		.10" (2.5mm)	.74" (18.8mm)
LT338BC		.13" (3.3mm)	.74" (18.8mm)
LT441BC		.21" (5.3mm)	.94" (23.9mm)

Heavy Duty Angle Face Tips

LT339BC		.09" (2.3mm)	.77" (19.6mm)
LT340BC		.12" (3.0mm)	.77" (19.6mm)
LT341BC		.16" (4.0mm)	.77" (19.6mm)

High Temperature Rated Heavy Duty SMD Knife Tip

LT570BC		.17" (4.3mm)	.68" (17.3mm)
---------	--	--------------	---------------

Heavy Duty Jumbo Spade & Angle Tips

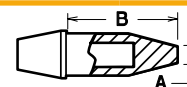





LT151B		.06" (1.5mm)	1.13" (28.7mm)
LT152B		.32" (8.1mm)	.89" (22.6mm)
LT155B		.33" (8.4mm)	.97" (24.6mm)

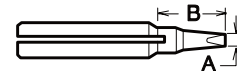

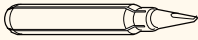

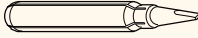
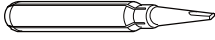
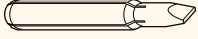
Extra Performance Spade Tips

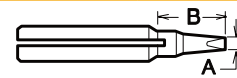

Part No.	Tip Image	Width A	Length B
XP371		.03" (.80mm)	.60" (15.2mm)
XP375		.06" (1.5mm)	.60" (15.2mm)
XP376		.12" (3.0mm)	.60" (15.2mm)
XP395		.09" (2.3mm)	.60" (15.2mm)
XP441		.22" (5.6mm)	.60" (15.2mm)
XP444		.04" (1mm)	.60" (15.2mm)

Extra Performance Conical Tips



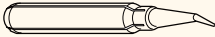



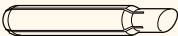

XP374		.03" (.8mm)	.60" (15.2mm)
XP429		.02" (.5mm)	.77" (19.3mm)

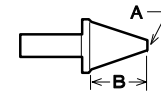
Extra Performance High Temperature Rated Angle Face Tip

XP399		.16 (4mm)	.60 (15.2mm)
-------	---	-----------	--------------

High Temperature Rated Iron-Plated General Purpose Tips



ZD12		.03" (0.8mm)	.50" (12.7mm)
ZD13		.04" (1.0mm)	.50" (12.7mm)
ZD14		.06" (1.5mm)	.50" (12.7mm)
ZD18		.07" (1.8mm)	.50" (12.7mm)
ZD19		.12" (3.0mm)	.50" (12.7mm)



Iron-Plated Funnel Tips

Part No.	Tip Image	Width A	Length B
ZD107		.02" (10.5mm)	.48" (12.2mm)
ZD111		.03" (0.8mm)	1.22" (31.0mm)
ZD112		.03" (0.8mm)	.48" (12.2mm)
ZD113		.04" (1.0mm)	.48" (12.2mm)
ZD115		.07" (1.8mm)	1.22" (31mm)
ZD118		.07" (1.8mm)	.48" (12.2mm)

Single Nozzle Tips



Part No.	Tip Image	Hole Dia. A	Length B
LT427		.02" (0.5mm)	.38" (95mm)
LT428		.06" (1.5mm)	.25" (6.4mm)
LT432		.04" (1.0mm)	.06" (1.5mm)
LT514		.10" (2.5mm)	.25" (6.4mm)

Fan Tips

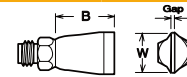

Part No.	Tip Image	Gap	Width W	Length B
LT426		.02" (0.5mm)	.30" (7.6mm)	.17" (4.3mm)
LT434		.02" (0.5mm)	.46" (11.7mm)	.23" (5.8mm)
LT435		.02" (0.5mm)	.59" (15.0mm)	.35" (8.9mm)
LT436		.02" (0.5mm)	.65" (16.5mm)	.43" (10.9mm)





Dual Flow Tips



Part No.	Tip Image	Hole Dia. A	Width W	Length B
LT526		.03" (0.8mm)	.12" (3.0mm)	.30" (7.6mm)
LT534		.05" (1.3mm)	.20" (5.1mm)	.46" (11.7mm)
LT535		.05" (1.3mm)	.28" (7.1mm)	.59" (15.0mm)
LT536		.05" (1.3mm)	.35" (8.9mm)	.65" (16.5mm)
LT537		.05" (1.3mm)	.44" (11.2mm)	.80" (20.4mm)

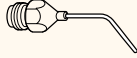



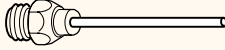
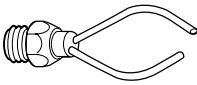

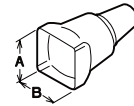

Curl/Bent Tips

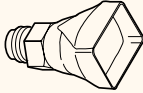
Part No.	Tip Image	Hole Dia.	Nozzle Length
LT510		.02" (0.5mm)	.65" (16.5mm)
LT511		.06" (1.5mm)	.65" (16.5mm)
LT512		.07" (1.8mm)	.90" (22.9mm)
LT513		.10" (2.5mm)	.90" (22.9mm)
LT571		.04" (1.0mm)	1.10" (27.9mm)
LT572		.04" (1.0mm)	MAX. GAP WIDTH 1.25" (31.8mm)

Quadra Flow Hot Air Tips



Part No.	Package	Tip Image	Width A	Length B
LT447	SO-8		.16" (4.0mm)	.20" (5.1mm)
LT448	SO-14		.21" (5.3mm)	.35" (8.9mm)
LT449	SO-16		.26" (6.6mm)	.41" (10.4mm)
LT450	SO-16L		.42" (10.7mm)	.43" (10.9mm)
LT451	SO-18L		.44" (11.2mm)	.48" (12.2mm)
LT452	SO-20L		.38" (9.5mm)	.52" (13.2mm)
LT454	SO-28L		.43" (10.9mm)	.73" (18.6mm)
LT455	PLCC-20		.40" (10.2mm)	.40" (10.2mm)
LT456	PLCC-28		.50" (12.7mm)	.50" (12.7mm)
LT458	PLCC-44 LCCC-44		.70" (17.8mm)	.70" (17.8mm)
LT459	PLCC-52 QFP-100		.80" (20.3mm)	.80" (20.3mm)



Quadra Flow Hot Air Tips

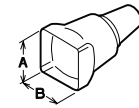





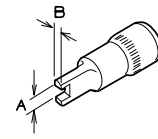

Part No.	Package	Tip Image	Width A	Length B
LT459-1			.80" (20.3mm)	.80" (20.3mm)
LT460	PLCC-68		1.0" (25.4mm)	1.0" (25.4mm)
LT462	PLCC-18		.34" (8.6mm)	.55" (14.0mm)
LT463	QFP-44		.60" (15.2mm)	.60" (15.2mm)
LT468	QFP-100		.66" (16.8mm)	.90" (22.9mm)
LT477			.75" (19mm)	1.0" (25.4mm)
LT478	LCCC-18R		.32" (8.1mm)	.45" (11.4mm)
LT482	LCCC-32R		.47" (11.9mm)	.58" (14.7mm)
LT484	SOJ-20		.40" (10.2mm)	.79" (20.1mm)
LT485			.52" (13.2mm)	.64" (16.3mm)
LT486	PLCC-28R		.40" (10.2mm)	.60" (15.2mm)
LT488	LCCC-84 QFP-144		1.17" (29.7mm)	1.17" (29.7mm)
LT493	SOJ-32		.48" (12.2mm)	.85" (21.6mm)
LT494	SOJ-40		.45" (11.4mm)	1.05" (26.7mm)
LT1629	SOP-44		.63" (16.0mm)	1.14" (29.0mm)
LT1824	QFP-100		.70" (17.8mm)	.94" (23.9mm)
LT2228			.85" (21.6mm)	1.1" (27.9mm)



CROWN[®] Contact Dual Surface Mount Tips



Part No.	Package	Tip Image	Width A	Length B
CT12	SOT-23		.07" (1.8mm)	.10" (2.5mm)
CT21	805		.09" (2.3mm)	.06" (1.5mm)
CT25	SOT-89		.10" (2.5mm)	.21" (5.3mm)
CT31	1206, 1210		.14" (3.5mm)	.07" (1.8mm)
CT42	1808, 1812		.19" (4.8mm)	.09" (2.3mm)
CT52	N/A		.20" (5.1mm)	.10" (2.5mm)
CT53	N/A		.23" (5.8mm)	.14" (3.5mm)

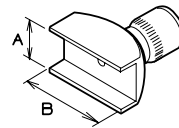

CROWN[®] Contact Tunnel SMD Tips

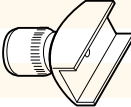
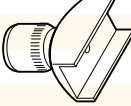
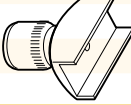

CT110	SOIC-18		.38" (9.5mm)	.40" (10.2mm)
CT113	SOIC-20		.38" (9.5mm)	.52" (13.2mm)
CT116	SOIC-24		.38" (9.5mm)	.62" (15.7mm)
CT118	SOIC-28		.38" (9.5mm)	.72" (18.2mm)
CT227	N/A		.45" (11.4mm)	1.08" (27.5mm)
CT504	SOIC-8		.20" (5.1mm)	.18" (4.5mm)
CT509	N/A		.20" (5.1mm)	.35" (8.9mm)
CT510	SOIC-14, 16		.20" (5.1mm)	.41" (10.4mm)
CT711	SOMC-16		.27" (6.9mm)	.45" (11.4mm)
CT919	SOJ-28		.34" (8.6mm)	.74" (18.9mm)

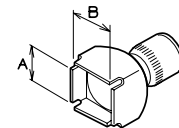
CROWN[®] Contact Quad SMD Tips

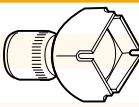
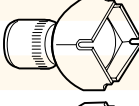
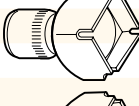

CT0808	N/A		.31" (7.9mm)	.31" (7.9mm)
CT0814	PLCC-18		.34" (8.6mm)	.54" (13.6mm)
CT1010	PLCC-20		.40" (10.2mm)	.40" (10.2mm)
CT1313	PLCC-28		.50" (12.7mm)	.50" (12.7mm)
CT1315	PLCC-32		.50" (12.7mm)	.60" (15.2mm)
CT1515	TQFP-100		.60" (15.2mm)	.60" (15.2mm)
CT1616	44-QFP		.64" (16.3mm)	.64" (16.3mm)
CT1723	64/80-QFP		.68" (17.3mm)	.92" (23.2mm)
CT1818	PLCC-44		.70" (17.8mm)	.70" (17.8mm)
CT2020	PLCC-52		.81" (20.6mm)	.81" (20.6mm)
CT2626	PLCC-68		1.0" (25.4mm)	1.0" (25.4mm)
CT3131	PLCC-84		1.20" (30.5mm)	1.20" (30.5mm)
CT3434	N/A		1.30" (33.5mm)	1.30" (33.5mm)



TSX70 SMT Reflow Vacuum Work Station Set Up

Part No.	Description
TSX70	SMT Reflow Vacuum Workstation

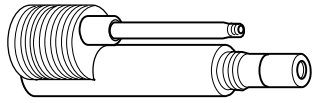

TSX70 Hollow Heater

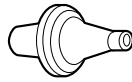

Reflow Vacuum Tip

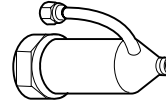

RSX72 Retaining Sleeve

Reflow Vacuum Tips

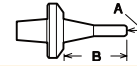

Part No.	Tip Image	Hole Dia. A	Length B
TSX713		.05" (1.3mm)	.55" (14.0mm)
TSX713C		.05" (1.3mm)	.55" (14.0mm)
TSX715 *to be used with TSX716		.09" (2.3mm)	.43" (10.9mm)
TSX716		.03" (0.8mm)	.80" (20.3mm)
TSX717		.011" (.28mm)	.63" (16.1mm)
TSX718		.03" (0.8mm)	.80" (20.3mm)



FUME EXTRACTION

Bench Top pgs 65 - 66
High Volume pgs 67 - 70
Installation Parts & Accessories pgs 71 - 73

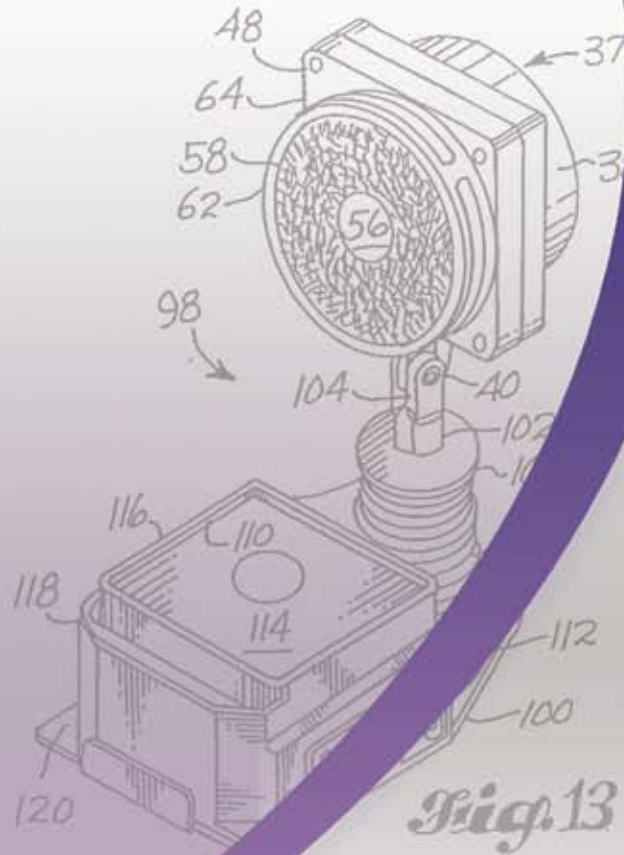

Edsyn values a safe working environment for its customers and has provided a full range of fume extraction solutions called the **FUMINATOR®** line.

From smaller bench top units to heavier duty volume fume extraction systems, all of our solutions are manufactured to strict quality standards and are virtually maintenance free.

A variety of arms, hoods, nozzles and funnels are also provided that will accommodate almost any requirement and industry need. Installation kits are also available to make installing your own system fast and easy.

FXF11/FXF12



FXF11

*Solder spool not included



FXF12

*Solder spool not included

Features

- Powerful bench top fume extraction system provides ultra-quiet and compact two stage filtration
- Proprietary FUMINATOR® rotating filter system draws fume away from operator and provides filtration 8 times better than a stationary filter
- Dual adjustment arm for more targeted fume removal
- Quick and easy filter replacement
- Internal safety grills
- ESD safe
- 90 day warranty (does not include filters)

FXF11 Contents







FXF10	FUMINATOR® bench top fume extractor fan
SR538	115-120 VAC wall transformer
SR542	Stand with solder peg (solder spool not included)

FXF12 Contents

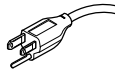
FXF10	FUMINATOR® bench top fume extractor fan
SR538	115-120 VAC wall transformer
SR541	Stand with solder peg and SH232 sponge holder (solder spool not included)

Replacement Filters

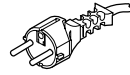
XF01	Filter set contains one each rotating front filter and charcoal impregnated stationary rear filter
XF02	Primary rotating filter (set of 5)
XF03	Charcoal impregnated stationary rear filter (set of 5)

Models & Specifications	FXF11 FXF12	FXF11-230B FXF12-230B	FXF11-230 FXF12-230
Power Requirements	12VDC	12VDC	12VDC
Plug/Power Supply	USA Standard	British	European
	 	 	 
Weight	FXF11 models - 1.09 lbs (.49 kg) FXF12 models - 1.28 lbs (.58 kg)		
Dimensions	5.5" W x 12" H x 5.5" D 102mm x 229mm x 102mm		
Max Airflow	49 cfm		
Noise Level	53 db		



FXF14/FXF14W



FXF14



FXF14W

Features

- Powerful bench top fume extraction system provides ultra-quiet and compact two stage filtration
- Proprietary FUMINATOR® rotating filter system draws fume away from operator and provides filtration 8 times better than a stationary filter
- Single Adjustable arm to almost any working angle (up to 90°)
- Quick and easy filter replacement
- Internal safety grills
- ESD safe
- 90 day warranty (does not include filters)

FXF15 Contents







FXF14	Black FUMINATOR® bench top fume extractor fan
SR538	115-120 VAC wall transformer

FXF14W Contents

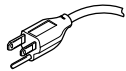
FXF14W	White FUMINATOR® bench top fume extractor fan
SR538	115-120 VAC wall transformer

Replacement Filters

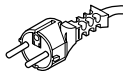
XF01	Filter set contains one each rotating front filter and charcoal impregnated stationary rear filter
XF02	Primary rotating filter (set of 5)
XF03	Charcoal impregnated stationary rear filter (set of 5)

Models & Specifications	FXF14	FXF14-230B	FXF14-230
	FXF14W	FXF14W-230B	FXF14W-230
Power Requirements	12VDC	12VDC	12VDC
Plug/Power Supply	USA Standard  	British  	European  
Weight		1.09 lbs (.49 kg)	
Dimensions		5.5"W x 12"H x 5.5"D 102mm x 229mm x 102mm	
Max Airflow		49 cfm	
Noise Level		53 db	

FX225



Features

- Compact, economic and hassle free fume extraction for 2 operators includes powerful self-contained unit with two 50mm arms attached
- High efficiency HEPA filtration 99.997% effective to 0.3 microns
- Easy installation
- Optional gas filtration available
- Thermal trip circuit
- Quick and easy filter change
- 12 month warranty

Specifications for Model FX225

Power Requirements	110/115V 60HZ
Airflow	120 cfm (filters installed)
Motor	Maintenance-free brushless
Noise level	55 dba
Overall Dimension	10H"x10D"x17W" 480mm x 260mm x 280mm
Weight	22 lbs/10 kg
Duct size	50mm
Max number of attachments	2

Contents

FX225-1	FUMINATOR® volume fume extraction unit
FXS5015-L	Extra long 50mm arms with nozzles (includes 2)
XF2501-1	Pre-filter (1 each)
XF2502	Combined filter

Options Available

FX225-230	FUMINATOR® volume fume extraction unit in 230 Volts
XF2503	Gas filter
FXS5016-L	Extra long 50mm arm with funnel attachment
FXT100	50mm fume extraction table top attachment (13" x 11")



FX300



Features

- Entry level fume extraction system offers outstanding value for two operator applications
- Quiet operation, small footprint and portability
- Comes standard with a pre-filter and a pleated main filter providing 95% filtration of particulate down to 0.5 microns
- HEPA and gas filters sold separately
- Easy filter change
- Quick and easy set up
- High efficiency (HEPA) and gas filters available
- 12 month warranty

Specifications for Model FX300

Power Requirements	115V 60Hz
Air Flow	Free blowing 280 cfm (188 cfm with filters installed)
Exhauster	Centrifugal fan with maintenance free brushless motor
Noise Level	Below 58 db
Overall Dimension	17" H x 13" W x 12" D 432mm x 330mm x 305m
Weight	33 lbs (15 kg)

Contents

FX300	FUMINATOR [®] entry level volume fume extractor
XF300	Filter pack includes pre-filter & foam filter

Options Available

FX300-230	FUMINATOR [®] entry level volume fume extractor in 230 Volts
XF2501	Pre-filter
XF2502	Combined filter
XF2503	Gas filter
FXS7518	ESD safe arm with funnel attachment

FX250



Features

- Quiet operation
- Small footprint
- Multi-user applications (up to 4 users)
- Powerful, self-contained vacuum
- Easy installation
- HEPA filtration 99.997% effective to 0.3 microns
- Filter change indicator gauge
- Thermal trip circuit
- Quick and easy filter change
- Economical
- 12 month warranty

Specifications for Model FX250

Power Requirements	110/115V 60HZ
Airflow	100 max cfm (filters installed)
Noise level	Below 52 dba
Overall Dimension	18½"H x 12"W x 12"D 470mm x 305mm x 305mm
Weight	51 lbs (23.2 kg)



Contents

FX250	FUMINATOR® high volume fume extractor unit
XF2501-1	Pre-filter (set of 1)
XF2502	Combined filter

Options Available

XF2503	Gas filter
--------	------------



FX600



Features

- Quiet operation
- Multi-user applications (up to 10 users)
- Portable
- Easy filter change
- Quick and easy set up
- Cost effective
- Outstanding value
- HEPA filtration 99.997% effective to 0.3 microns
- 12 month warranty

Specifications for Model FX600

Power Requirements	110/115V 60HZ
Air Flow	320 cfm (filters installed)
Noise Level	Below 45db
Overall Dimension	25" H x 16" W x 20" D 635mm x 406mm x 508mm
Weight	98 lbs (45 kg)

Contents







FX600	FUMINATOR [®] high volume fume extractor unit
XF600-PF	Filter pack includes pre-filter
XF600-CF	Combined filter











FUMINATOR® Installation Parts and Attachments

Part #	Image	Description	FX225	FX250	FX300	FX600
FXC501		50mm Clear Cowl Accessory - includes 6 feet flex-hose and 2 clamps	X	X	X	X
FXC502		50mm Black ESD Safe Cowl Accessory - includes 6 feet flex-hose and 2 clamps	X	X	X	X
FXC751		75mm Clear Cowl Accessory - includes 6 feet flex-hose and 2 clamps		X	X	X
FXC752		75mm Black ESD Safe Cowl Accessory - includes 6 feet flex-hose and 2 clamps		X	X	X
FXI300-4X		Installation Kit comes with: <ul style="list-style-type: none"> • 1 pc. replacement lid with 8 pcs 50mm inlets • 4 pcs. table bracket with flush seal system • 4 pcs. balancing valve • 10 meters of 50mm flex hose and 8 cinch clips) 			X	
FXI300-4N		Installation Kit comes with: <ul style="list-style-type: none"> • 1 pc. replacement lid with 8 pcs. 50mm inlets • 4 pcs. table bracket with flush seal system • 4 pcs. balancing valve • 10 meters of 50mm flex hose and 8 cinch clips • 4 pcs. FXS5015 50mm arms with nozzle attachments 			X	
FXI300-4F		Installation Kit comes with: <ul style="list-style-type: none"> • 1 pc. replacement lid with 8 pcs. 50mm inlets • 4 pcs. table bracket with flush seal system • 4 pcs. balancing valve • 10 meters of 50mm flex hose and 8 cinch clips • 4 pcs. FXS5016 50mm arms with funnel attachments 			X	



Part #	Image	Description	FX225	FX250	FX300	FX600
FXM5002		50mm Flex Tubing		X	X	X
FXM7502		75mm Flex Tubing		X	X	X
FXM7513		75mm Cinch Clips		X	X	X
FXM5013		50mm Cinch Clips		X	X	X
FXM7503		75mm T Fitting		X	X	X
FXM7511		75/50mm Reducer		X	X	X
FXM7516		75mm Y Fitting		X	X	X
FXM7517		75/50mm Reducer with Balancing Valve		X	X	X
FXS5008		Flush Seal System	X	X	X	X
FXS5015		50mm Arm with Nozzle Length: 34 inches (.86 meters)	X	X	X	X
FXS5016		50mm Arm with Funnel Length: 34 inches (.86 meters)	X	X	X	X

Part #	Image	Description	FX225	FX250	FX300	FX600
FXS5017		50mm Arm with Fan Nozzle Length: 34 inches (.86 meters)	X	X	X	X
FXS7510		75mm Table Bracket		X	X	X
FXS7516		75mm Arm with Table Bracket Length: 32 inches (.81 meters)		X	X	X
FXS7518		75mm Arm with Funnel Length: 42 inches (1.07 meters)		X	X	X
FXS5015-L		Extra long 50mm arm with Nozzle Length: 46 inches (1.17 meters)	X			
FXS5016-L		Extra long 50mm arm with Funnel Length: 46 inches (1.17 meters)	X			
FXT100		Downdraft Table	X	X	X	X
FXT200		Downdraft Table		X	X	X
FXT300		Downdraft Table		X	X	X



ACCESSORIES

Production Aids pgs 75 - 77
Desoldering Braids pg 78
Pick Up Tools & Needles pgs 79 - 81

Note: This section is limited. For a complete list ask for Edsyn's Hand Tools Catalog solely dedicated to production aids and accessories.



Edsyn is proud to present a new line of accessories and production aids specifically designed to complement our current line of soldering, desoldering and SMT stations.

In the following pages, you will discover a wide variety of hand tools and production aids that offer new techniques for most any assembly and rework requirement. You are sure to find the perfect tool for a perfect job at any budget.

We make it our aim to have all of these tools in stock and ready to ship. Can't find the tool you're looking for in these pages? Call us for a custom made solution and let us bring our innovative ideas to life for you.

EZP01 *New Technology*

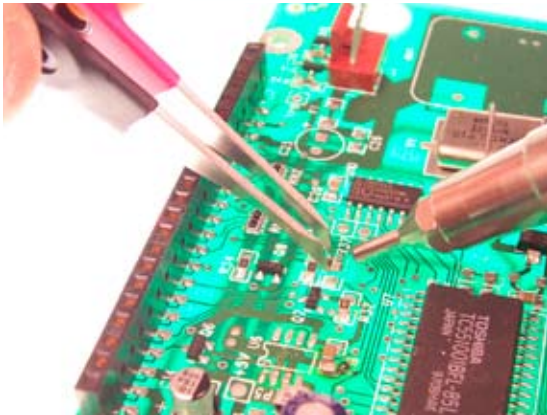

In & Out of Circuit Readings

There may be a need to measure a drop across the component and check the value outside the circuit. You can do this without letting go and using hot air.

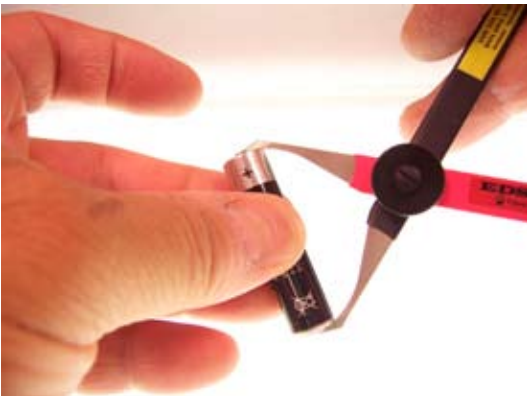

Scissor Configuration

Putting the red blade on top of the black blade and securing it with the spacing adjuster you have a scissor action. This is perfect when you have a greater span to measure

Note: This section is limited. For a complete list ask for Edsyn's Hand Tools Catalog solely dedicated to production aids and accessories.

Features

- All-in-one test probe and tweezer solution
- 301 stainless steel construction
- Side stacking banana jacks
- Flexible boot to reduce wire strand fatigue
- Lightweight 24 gauge stranded wire
- Configurable spacing adjuster to 5/8"
- Surface ground dual pickup points
- Separates and can be used as regular probes
- Grabs small components or larger items with complete stability
- Ability to hold parts from the inside or outside
- Adjustable scissor configuration allows user to probe with scissor motion for large spans

Contents

- EZP01 Easy probe tweezers (does not come with multi-meter)

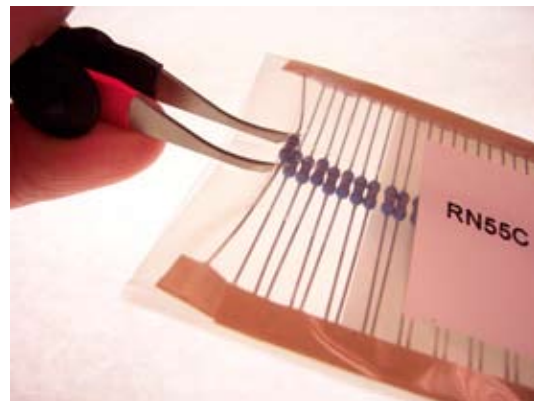

Part Inspection Inside Packaging

To verify the values of components you can pierce through the packaging to get a reading without having to break open the packaging. Some metal film resistor body color changes the band color.





CT-1

- CROWN[®] lead-free tip tinner and cleaner to maintain your Edsyn CROWN[®] tips or any heavy duty tips (1.5 oz. or 42.5g)



LT-1

- LONER[®] lead-free tip tinner and cleaner to maintain your Edsyn LONER[®] soldering tips (.5 oz or 14.2g)



WT618

- Dual ended wrench for removing hot air tips (set of 2)



WP286

- WIGAPRY[®] desoldering aid
- Use to straighten pins or leads and remove circuit devices



RB641

- SMD shim blade replacement with static-safe spool holder to be used with ST706 or ST800 SMD helpers



WT619

- Tip wrench for removing desoldering tips using RS383 retaining sleeve (comes with UC274 clamp for attaching to station for easy access)



WP556

- WIGAPRY[®] mini screwdriver and calibration aid tool



WS630

- SMD pull wire replacement and static-safe spool holder to be used with ST706 or ST800 SMD helpers [Dia: .01 in. (.25 mm) L: 10 ft (3.05 m)]



WT620

- Socket wrench for removing smaller hot air tips that use RN432 and RN433 retaining nuts



ST800

- SMD helper helps remove surface mount devices while using soldering or hot air tools



TC383

- K-Type thermocouple and subminiature connector assembly with ZD13 desoldering tip and RS383 retaining sleeve attached (use as a calibration aid with MS412 temperature measuring system)



OL111

- O-Ring lube for lubrication and longer tool life



ST706

- SMD helper helps lift and remove surface mount devices while using hot air tools (.002 shim, .238 width)

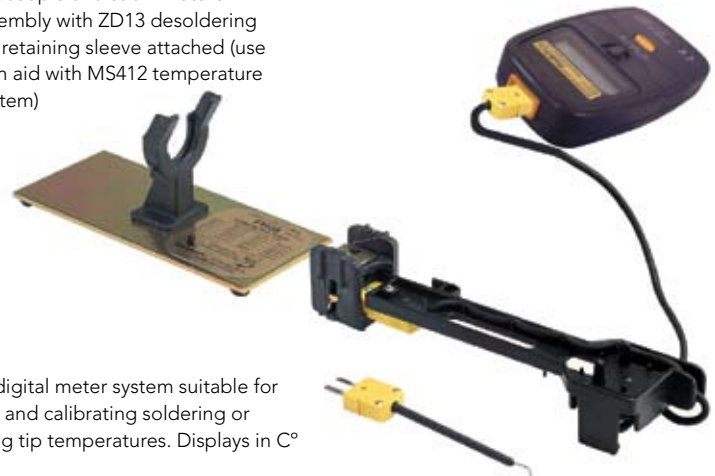

MS412

- Compact digital meter system suitable for measuring and calibrating soldering or desoldering tip temperatures. Displays in C° and F°.

Note: This section is limited. For a complete list ask for Edsyn's Hand Tools Catalog solely dedicated to production aids and accessories.





DS299

- KLATCH® dip squeezers for grabbing or removing circuit devices comes with RS190 sponge and AF039 foam for cleaning and scrubbing



EA439-C

- Dry soldering tip cleaner and stand comes with EA439-1 replacement metallic tip cleaning element



ST707

- Soldering tool maintenance and cleaning brush



ST707-1

- Replacement stainless steel brush for ST707



TH101

- Tip organizer and holder with dovetail slide mount for easy attachment to your station comes with TH100 tip organizer (holds 3 heavy duty tips and 4 standard tips)



SD300

- Solder spool holder with dovetail slide mount for easy attachment to your station (solder not included)



SD302

- Solder spool holder and tip organizer comes with TH100 tip organizer and dovetail slide mount for easy attachment to your station (solder & tips not included)



SL287LF

- Static-Safe solder spool holder with self-adhesive bottom for lead-free solder (solder not included)



SL287LS

- Static-Safe solder spool holder with self-adhesive bottom (solder not included)



AN122

- High heat anti-seize syringe dispenser (2.5 cc/2.4 ml/2.7 g)



AN112

- Anti-Seize compound prevents seizure from 65°F up to 2000°F (2cc)



CS468

- Tip cleaning shaft for hot tip desoldering tips [Shaft Dia: .05 in. (1.27 mm) L: 1.73 in. (43.4 mm)]



CS468-1

- Tip cleaning shaft for hot tip desoldering tips [Shaft Dia: .025 in. (.635 mm) L: 1.73 in. (43.9 mm)]



CS468-2

- Tip cleaning shaft for hot tip desoldering tips [Shaft Dia: .01 in. (.25 mm) L: 1.73 in. (43.9 mm)]



CSX70

- Maintenance tool with cleaning shaft for all versions of model TSX70 [Shaft Dia: .22 in. (5.6 mm) L: 3.38 in. (85.9 mm)]

Note: This section is limited. For a complete list ask for Edsyn's Hand Tools Catalog solely dedicated to production aids and accessories.



www.edsyn.com



Part #	Description
No Clean SOLDASIP[®] Desoldering Braids	
SW081	Size #1 - White desolder braid .035 in. x 5 ft. (.9mm x 1.5mm) comes with static-safe bobbin
SW081-10	Size #1 - White desolder braid .035 in. x 10 ft. (.9mm x 3mm) comes with static-safe bobbin
SW082	Size #2 - Yellow desolder braid .055 in. x 5 ft. (1.4mm x 1.5mm) comes with static-safe bobbin
SW082-10	Size #2 - Yellow desolder braid .035 in. x 10 ft. (1.4mm x 3mm) comes with static-safe bobbin
SW083	Size #3 - Green desolder braid .075 in. x 5 ft. (1.9mm x 1.5mm) comes with static-safe bobbin
SW083-10	Size #3 - Green desolder braid .075 in. x 10 ft. (1.9mm x 3mm) comes with static-safe bobbin
SW084	Size #4 - Blue desolder braid .098 in. x 5 ft. (2.5mm x 1.5mm) comes with static-safe bobbin
SW084-10	Size #4 - Blue desolder braid .098 in. x 10 ft. (2.5mm x 3mm) comes with static-safe bobbin
SW085	Size #5 - Brown desolder braid .13 in. x 5 ft. (3.3mm x 1.5mm) comes with static-safe bobbin
SW085-10	Size #5 - Brown desolder braid .13 in. x 10 ft. (3.3mm x 3mm) comes with static-safe bobbin
SW086	Size #6 - Red desolder braid .19 in. x 5 ft. (4.9mm x 1.5mm) comes with static-safe bobbin
Rosin SOLDASIP[®] Desoldering Braids	
SW091	Size #1 - White desolder braid .035 in. x 5 ft. (.9mm x 1.5mm) comes with static-safe bobbin
SW091-10	Size #1 - White desolder braid .035 in. x 10 ft. (.9mm x 3mm) comes with static-safe bobbin
SW092	Size #2 - Yellow desolder braid .055 in. x 5 ft. (1.4mm x 1.5mm) comes with static-safe bobbin
SW092-10	Size #2 - Yellow desolder braid .035 in. x 10 ft. (1.4mm x 3mm) comes with static-safe bobbin
SW093	Size #3 - Green desolder braid .075 in. x 5 ft. (1.9mm x 1.5mm) comes with static-safe bobbin
SW093-10	Size #3 - Green desolder braid .075 in. x 10 ft. (1.9mm x 3mm) comes with static-safe bobbin
SW094	Size #4 - Blue desolder braid .098 in. x 5 ft. (2.5mm x 1.5mm) comes with static-safe bobbin
SW094-10	Size #4 - Blue desolder braid .098 in. x 10 ft. (2.5mm x 3mm) comes with static-safe bobbin
SW095	Size #5 - Brown desolder braid .13 in. x 5 ft. (3.3mm x 1.5mm) comes with static-safe bobbin
SW095-10	Size #5 - Brown desolder braid .13 in. x 10 ft. (3.3mm x 3mm) comes with static-safe bobbin
SW096	Size #6 - Red desolder braid .19 in. x 5 ft. (4.9mm x 1.5mm) comes with static-safe bobbin

Note: This section is limited. For a complete list ask for Edsyn's Hand Tools Catalog solely dedicated to production aids and accessories.





LP21 *New Technology*

- Dual ended portable vacuum lifter & retractable tweezer port (includes tweezers)
- Lifts devices using vacuum or tweezers
- Wet/dry syringe capabilities for vacuum pickup and blowing or for injecting, spraying, or extracting liquids

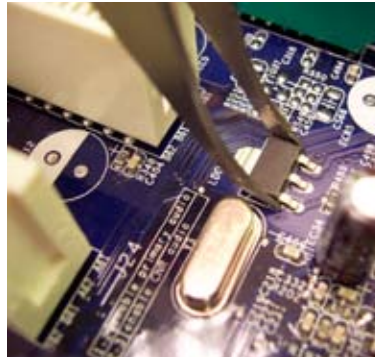

Dual Action Technology

LP21 picks up components using retractable tweezers or vacuum to lift more sensitive devices

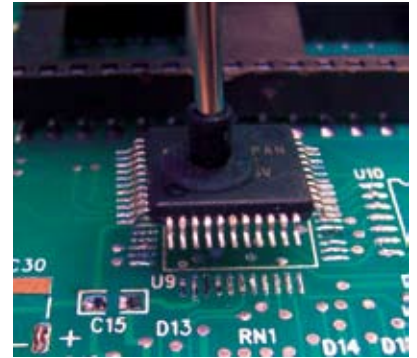

VA175 *New Technology*

- Air & Vacuum Pick Up System requires 60-90 psi. Uses vacuum or positive air pressure to create a lifting action for sensitive parts handling and cooling at the same time. Accepts a wide variety of suction cups and needle sizes (includes LP252 handpiece).



VA251

- Vacuum Pick Up System allows users to achieve maximum performance in a self-contained unit. Ultra light weight hand piece accepts a wide variety of suction cups and needle sizes (includes LP265 handpiece).



LP20

- This is the smallest addition to our line of portable lifting tools. Features a small yet powerful vacuum pick up system with tweezer like handling for compact areas. Also ESD safe.





























LP200

- Our most popular portable lifting kit. Comes standard with 3 different needles. A small and lightweight tool with single sided vacuum bar and pocket clip for portability. Also ESD safe.

Note: This section is limited. For a complete list ask for Edsyn's Hand Tools Catalog solely dedicated to production aids and accessories.































Part #	Image	Description	LP20	LP200	VA175	VA251
Standard Purpose Needles						
LN250		Small Angled Lifting Needle with SP125 1/8" Suction Cup	X	X	X	X
LN251		Small Straight Lifting Needle with SP125 1/8" Suction Cup	X	X	X	X
LN260		Med. Angled Lifting Needle with SP250 1/4" Suction Cup	X	X	X	X
LN261		Med. Straight Lifting Needle with SP250 1/4" Suction Cup	X	X	X	X
LN270		Large Angled Lifting Needle with SP375 3/8" Suction Cup	X	X	X	X
LN271		Large Straight Lifting Needle with SP375 3/8" Suction Cup	X	X	X	X
Non-Reflective Needles						
LN250S		Small Angled Lifting Needle with SP125 1/8" Suction Cup	X	X	X	X
LN251S		Small Straight Lifting Needle with SP125 1/8" Suction Cup	X	X	X	X
LN260S		Med. Angled Lifting Needle with SP250 1/4" Suction Cup	X	X	X	X
LN261S		Med. Straight Lifting Needle with SP250 1/4" Suction Cup	X	X	X	X
LN270S		Large Angled Lifting Needle with SP375 3/8" Suction Cup	X	X	X	X
LN271S		Large Straight Lifting Needle with SP375 3/8" Suction Cup	X	X	X	X
Precision Stainless Steel Needles - use with LNA27 & RCA27						
LN275		Angled Lifting Needle OD: .03" (.76mm)			X	X
LN275-1		Angled Lifting Needle OD: .02" (.5mm)			X	X
LN275-2		Angled Lifting Needle OD: .01" (.2mm)			X	X
LN276		Angled Lifting Needle OD: .07" (1.8mm)			X	X
LN277		Angled Lifting Needle OD: .05" (1.3mm)			X	X
LN278		Angled Lifting Needle OD: .05" (1.3mm)			X	X
LN279		Angled Lifting Needle OD: .03" (.76mm)			X	X
LN282		Angled Lifting Needle OD: .07" (1.8mm)			X	X
Suction Cups - Use with Standard Purpose and Non-Reflective Needles Only						
SP375		3/8" Static-Safe Silicone Suction Cup	X	X	X	X
SP250		1/4" Static-Safe Silicone Suction Cup	X	X	X	X
SP125		1/8" Static-Safe Silicone Suction Cup	X	X	X	X
SP093		3/32" Static-Safe Silicone Suction Cup	X	X	X	X
SP750		3/4" Static-Safe Silicone Suction Cup	X	X	X	X
SP625		5/8" Static-Safe Silicone Suction Cup	X	X	X	X
SP500		1/2" Static-Safe Silicone Suction Cup	X	X	X	X

Note: This section is limited. For a complete list ask for Edsyn's Hand Tools Catalog solely dedicated to production aids and accessories.



Pick Up Tool Needles and Suction Cups

Part #	Image	Description	LP20	LP200	VA175	VA251
Suction Cups - Use with Standard Purpose and Non-Reflective Needles Only						
SP750R		3/4" Static-Safe Silicone Suction Cup with Stabilizing Insert			X	X
SP500R		1/2" Static-Safe Silicone Suction Cup with Stabilizing Insert			X	X
SP375R		3/8" Static-Safe Silicone Suction Cup with Stabilizing Insert			X	X
SP750W		3/4" Clear Silicone Suction Cup with PTFE Stabilizing Insert			X	X
SP500W		1/2" Clear Silicone Suction Cup with PTFE Stabilizing Insert			X	X
SP375W		3/8" Clear Silicone Suction Cup with PTFE Stabilizing Insert			X	X
SPA25		3/8" Minimal Touch Air & Pick Up Lifter with Suction Cup - Use with LN276 Precision Stainless Steel Needle only (pictured with SPJ19 sold separately)			X	X
DELTRIN High-Tech Lifting Needles - use with RCA27						
LN400		Straight Lifting Needle OD: .02" (.5mm) ID: .005" (.12mm)			X	X
LN401		Straight Lifting Needle OD: .02" (.5mm) ID: .01" (.25mm)			X	X
LN402		Straight Lifting Needle OD: .03" (.76mm) ID: .02" (.5mm)			X	X
LN403		Straight Lifting Needle OD: .04" (1.0mm) ID: .03" (.76mm)			X	X
LN404		Straight Lifting Needle OD: .06" (1.5mm) ID: .04" (1.0mm)			X	X
LN405		Straight Lifting Needle OD: .08" (2.0mm) ID: .06" (1.5mm)			X	X
LN400-1		Angled Lifting Needle OD: .02" (.5mm) ID: .005 (.12mm)			X	X
LN401-1		Angled Lifting Needle OD: .02" (.5mm) ID: .01" (.25mm)			X	X
LN402-1		Angled Lifting Needle OD: .03" (.76mm) ID: .02" (.5mm)			X	X
LN403-1		Angled Lifting Needle OD: .04" (1.0mm) ID: .03" (.76mm)			X	X
LN404-1		Angled Lifting Needle OD: .06" (1.5mm) ID: .04" (1.0mm)			X	X
LN405-1		Angled Lifting Needle OD: .08" (2.0mm) ID: .06" (1.5mm)			X	X
TORLON High-Temperature Lifting Needles - use with RCA27						
LN401T		Straight Lifting Needle OD: .02" (.5mm) ID: .005" (.12mm)			X	X
LN402T		Straight Lifting Needle OD: .03" (.76mm) ID: .02" (.5mm)			X	X
LN403T		Straight Lifting Needle OD: .04" (1.0mm) ID: .03" (.76mm)			X	X
LN404T		Straight Lifting Needle OD: .06" (1.5mm) ID: .04" (1.0mm)			X	X
LN405T		Straight Lifting Needle OD: .08" (2.0mm) ID: .06" (1.5mm)			X	X
LN401T-1		Angled Lifting Needle OD: .02" (.5mm) ID: .01" (.25mm)			X	X
LN402T-1		Angled Lifting Needle OD: .03" (.76mm) ID: .02" (.5mm)			X	X
LN403T-1		Angled Lifting Needle OD: .04" (1.0mm) ID: .03" (.76mm)			X	X
LN404T-1		Angled Lifting Needle OD: .06" (1.5mm) ID: .04" (1.0mm)			X	X
LN405T-1		Angled Lifting Needle OD: .08" (2.0mm) ID: .06" (1.5mm)			X	X

Note: This section is limited. For a complete list ask for Edsyn's Hand Tools Catalog solely dedicated to production aids and accessories.



www.edsyn.com

Index

930 14
935 15
951SX 16
951DX-230 16
951DX-230B 16
951SX-230 16
951SX-230B 16
951SX-230I 16
952SX 17
952DX-230 17
952DX-230B 17
971 18
971-230B 18
971-230I 18
971DH-230 39
971DH-230B 39
971DX-230 18
971DX-230B 18
971DX-230I 18
971HA 39
971HA-230I 39
1036 40
1036-230B 40
1036DX 41, 42
1036DX-230B 40
1036DX/B-230 40
1072 50
1072DX-230 50
1072DX-230B 50
2020 13
2020-230 13
2020-230B 13

A

AC157 26, 27
AC157-1 26, 27
AC735 26, 28, 42, 53, 54
Accessories Section 74-81
AF040 31, 32, 51, 52
AF110 31, 32, 49, 51, 52
AF624 49
AF625 31, 32, 49, 51, 52
AF629 31, 32, 49, 51, 52
AN112 77
AN122 77
AS196 33

B

Bench Top Fume Extraction 65, 66

C

CL1080 20
CL1080-K 21
CL1180 20
CL1280 20
CL1280I 20
CL1481 20
CL1481-K 21
CL1580I 20
CROWN® Quad SMD Tips 29
CROWN® Series Contact Surface
Mount Tips 29
CROWN® Tunnel SMD Tips 29
CS468 77
CS468-1 77
CS468-2 77
CSX70 49, 77
CT-1 76
CT12 29, 46, 62
CT21 29, 46, 62
CT25 29, 46, 62
CT31 29, 46, 62
CT42 29, 46, 62
CT52 29, 46, 62
CT53 29, 46, 62
CT110 29, 46, 62
CT113 29, 46, 62
CT116 29, 46, 62
CT118 29, 46, 62
CT227 29, 46, 62
CT504 29, 46, 62
CT509 29, 47, 62
CT510 29, 47, 62
CT711 29, 47, 62
CT0808 29, 47, 62
CT0814 29, 47, 62
CT919 29, 47, 62
CT1010 29, 47, 62
CT1313 29, 47, 62
CT1315 29, 47, 62
CT1515 29, 47, 62
CT1616 29, 47, 62
CT1723 29, 47, 62
CT1818 29, 47, 62
CT2020 29, 47, 62
CT2626 29, 47, 62
CT3131 29, 47, 62
CT3434 29, 47, 62
CTA02 28, 53, 54
CTA03 28, 54
CTS71 28, 53, 54

D

Desoldering Section 30-37
Desoldering Braids 78
Desoldering Hot Tips 36, 58, 59
 Iron-Plated General Purpose
 Tips 36, 58
 Iron-Plated Funnel Tips 36, 59
Desoldering Tips & O-Rings 37
 Portable Replacement Tips
 and O-Rings 37
DS017 33
DS017LS 33
DS117 34
DS299 77
DS317 34
DS517 34

E

EA439-C 77
EA73-105 21
EA73-110 21
Easy Probe Tweezers 75
Extra Performance
 Soldering Tips 27, 58
EZP01 75

F

FA069 40, 52
Fume Extraction Section 64-73
Fuminator® Installation Parts &
 Accessories 71-73
FX225 67
FX225-1 67
FX225-230 67
FX250 69
FX300 68
FX300-230
FX600 70
FXC501 71
FXC502 71
FXC751 71
FXC752 71
FXF10 65
FXF11 65
FXF11-230 65
FXF11-230B 65
FXF12 65
FXF12-230 65
FXF12-230B 65
FXF14 66
FXF14-230 66
FXF14-230B 66
FXF14W 66
FXF14W-230 66
FXF14W-230B 66

FXI300-4F 71
FXI300-4N 71
FXI300-4X 71
FXM5002 72
FXM5013 72
FXM7502 72
FXM7503 72
FXM7511 72
FXM7513 72
FXM7516 72
FXM7517 72
FXS5008 72
FXS5015 72
FXS5015-L 67, 73
FXS5016 72
FXS5016-L 67, 73
FXS5017 73
FXS7510 73
FXS7516 73
FXS7518 73
FXT100 73
FXT200 73
FXT300 73

G

General Purpose
Soldering Tips 23, 55

H

HC273 22, 42
Heavy Duty Soldering Tips 26, 57
High Temperature Rated
Soldering Tips 24-25, 55-57
High Volume Fume Extraction
Systems 67-70
Hot Air Stations 39-41
Hot Air Tips 43-45, 59-61
HS106BC 26, 57
HS106BC-5 57
HT500 32, 51, 52
HT500-2 31

I

Installation Parts &
Accessories 71-73

IP329 14, 20
IP481 20
IP489 20
IR089 20
Irons 20, 21

L

LN230 14-18, 39-41, 50
LN250 80
LN250S 80
LN251 80

LN251S 80
LN260 80
LN260S 80
LN261 80
LN261S 80
LN270 80
LN270S 80
LN271 80
LN271S 80
LN275 80
LN275-1 80
LN275-2 80
LN276 80, 81
LN277 80
LN278 80
LN279 80
LN282 80
LN400 81
LN400-1 81
LN401 81
LN401-1 81
LN401T 81
LN401T-1 81
LN402 81
LN402-1 81
LN402T 81
LN402T-1 81
LN403 81
LN403-1 81
LN403T 81
LN403T-1 81
LN404 81
LN404-1 81
LN404T 81
LN404T-1 81
LN405 81
LN405-1 81
LN405T 81
LN405T-1 81
LP20 79
LP21 79
LP200 79
LP250 41
LS197 37
LS363 37
LS363A 37
LS364A 37
LS561 37
LS751 37
LS915 37
LST11 51, 52
LT-1 77
LT20A 26, 27
LT151B 26, 57
LT152B 26, 57
LT155B 26, 57
LT298LF 25, 56
LT299LF 25, 56

LT336BC 26, 57
LT337BC 26, 57
LT338BC 26, 57
LT339BC 26, 57
LT340BC 26, 57
LT341BC 26, 57
LT371LF 24, 55
LT373LF 25, 56
LT374 23, 55
LT374LF 24, 56
LT375 23, 55
LT375LF 24, 55
LT376 23, 55
LT376LF 24, 55
LT380LF 24, 56
LT382 23, 55
LT382LF 24, 56
LT383LF 24, 56
LT387LF 25, 56
LT392-1LF 25, 57
LT392LF 24, 56
LT393LF 25, 56
LT394 23, 55
LT394LF 24, 55
LT395 23, 55
LT395LF 24, 55
LT396LF 25, 57
LT398LF 25, 56
LT399LF 25, 56
LT424LF 24, 55
LT425LF 24, 55
LT426 43, 59
LT427 43, 59
LT428 43, 59
LT429 23, 55
LT429-1 23, 55
LT429LF 24, 56
LT430LF 25, 56
LT431 23, 55
LT431LF 24, 56
LT432 43, 59
LT433LF 25, 56
LT434 43, 59
LT435 43, 59
LT436 43, 59
LT439-1LF 25, 57
LT439LF 24, 56
LT441BC 26, 57
LT443LF 25, 56
LT444 23, 55
LT444-1LF 25, 57
LT444LF 24, 56
LT446LF 24, 56
LT447 44, 60
LT448 44, 60
LT449 44, 60
LT450 44, 60
LT451 44, 60

LT452 44, 60
LT454 44, 60
LT455 44, 60
LT456 44, 60
LT458 44, 60
LT459 45, 60
LT459-1 61
LT460 45, 61
LT462 45, 61
LT463 45, 61
LT468 45, 61
LT477 45, 61
LT478 45, 61
LT482 45, 61
LT484 45, 61
LT485 45, 61
LT486 45, 61
LT488 45, 61
LT493 45, 61
LT494 45, 61
LT510 43, 60
LT511 43, 60
LT512 43, 60
LT513 43, 60
LT514 43, 59
LT526 43, 59
LT534 43, 59
LT535 43, 59
LT536 43, 59
LT537 43, 59
LT570BC 26, 57
LT571 43, 60
LT572 43, 60
LT602-1LF 25, 57
LT603LF 24, 56
LT1629 45, 61
LT1824 45, 61
LT2228 45, 61
LTA02 42, 53, 54
LTC7 22
LTC71 22, 27, 28, 54
LU25 44
LU26 44
LU27 44
LU28 44
LU29 44
LU30 44
LU571 44
LU572 44
LUA21 42

M

MCA01 19
MCA02 19
MRT16 37
MS229 31, 32, 49, 51, 52
MS412 76
Multi-Tasking Section 48-63

O

OA193 34, 37
OA195 34, 37
OA197 34, 37
ODS31 37
OL111 76
OS130 37
OSB32 37

P

PD525 40
PD528 13, 14, 15, 16, 17, 18, 19, 50
PD532 41
PD533 39, 41, 50
PH177 34
PH178 34
PH184 34
PH246 34
PH247 34
PH358 34
Pick Up Tools 79
Pick Up Tool Needles &
Suction Cups 80, 81
PR570 39, 50
Probe Tweezers 75
PS536 15
PSS2000 19
PT109 33
PT209 33
PT409 33

R

RB641 39, 40, 50, 76
RC306 26
RCS7 22
RCS71 22, 27, 28, 54
Reflow Vacuum Tips 63
RS199 14-19, 31-32, 39-41, 49-50
RS243 14-19, 39-41, 50
RS271 26, 53, 54
RS321 42, 53, 54
RS372 22, 26, 53, 54
RS383 36, 53, 54
RSX72 63

S

SD300 77
SD302 77
SH230 14-18, 32, 39-41, 50
SH232 31, 49, 65
SH235 13, 19
SL287LF 77
SL287LS 77
SMT CROWN® Tips 29, 46, 47, 62
SMT Hot Air Tips 43-45, 59-61
SMT Reflow Vacuum Tips 63

SMT Reflow Vacuum
Work Station 49
SMT Section 39-47
Soldering Irons & Kits 20-21
Soldering Section 12-29
Soldering Stations 12-19
Soldering Tips 22-29, 55-58
CROWN® SMT Tips 29, 46, 47, 62
Extra Performance
Soldering Tips 27, 58
General Purpose
Soldering Tips 23, 55
Heavy Duty Soldering Tips 26, 57
High Temperature Rated Soldering
Tips 24-25, 55-57
SP093 80
SP125 80
SP250 80
SP375 80
SP375R 81
SP375W 81
SP500 80
SP500R 81
SP500W 81
SP625 80
SP750 80
SP750R 81
SP750W 81
SPA25 81
SR538 65, 66
SR541 65
SR542 65
SRT12 37
SS011 33
SS102 33
SS343 33
SS350 33
SS750LS 33
ST706 76
ST707 77
ST707-1 77
ST800 76
Suction Cups 80, 81
SW081 78
SW081-10 78
SW082 78
SW082-10 78
SW083 78
SW083-10 78
SW084 78
SW084-10 78
SW085 78
SW085-10 78
SW086 78
SW091 78
SW091-10 78
SW092 78
SW092-10 78

SW093 78
SW093-10 78
SW094 78
SW094-10 78
SW095 78
SW095-10 78
SW096 78

T

TA350 26
TC383 76
Test Probe Tweezers 75
TH101 77
TSX70 49
TSX70-230B 49
TSX70-230I 49
TSX713 63
TSX713C 63
TSX715 63
TSX716 63
TSX717 63
TSX718 63

U

US140 33
US340 33

V

VA175 79
VA251 79
Vacuum Generators 35
Volume Fume Extraction
Systems 67-70
VP171 35
VS171A 35

W

WP286 76
WP556 76
WS630 76
WT618 76
WT619 76
WT620 76
WT623 31, 32, 41, 49, 51, 52
WT624 39, 40, 41, 49, 50

X

XF01 65, 66
XF02 65, 66
XF03 65, 66
XF300 68
XF600-CF 70
XF600-PF 70
XF2501 68
XF2501-1 67, 69
XF2502 67, 68, 69
XF2503 67, 68, 69

XP371 27, 58
XP374 27, 58
XP375 27, 58
XP376 27, 58
XP395 27, 58
XP399 27, 58
XP429 27, 58
XP441 27, 58
XP444 27, 58

Z

ZD12 36, 58
ZD13 36, 58
ZD14 36, 58
ZD18 36, 58
ZD19 36, 58
ZD107 36, 59
ZD111 36, 59
ZD112 36, 59
ZD113 36, 59
ZD115 36, 59
ZD118 36, 59
ZD500DX 31
ZD500DX-230 31
ZD500DX-230B 31
ZD500DX-230I 31
ZD505V 32
ZD505V-230 32
ZD505V-230B 32
ZD505V-H9-230B 32
ZD905V 51
ZD905V-230 51
ZD905V-230B 51
ZD906 52
ZD906-230 52
ZD906-230B 52
ZD906-230I 52

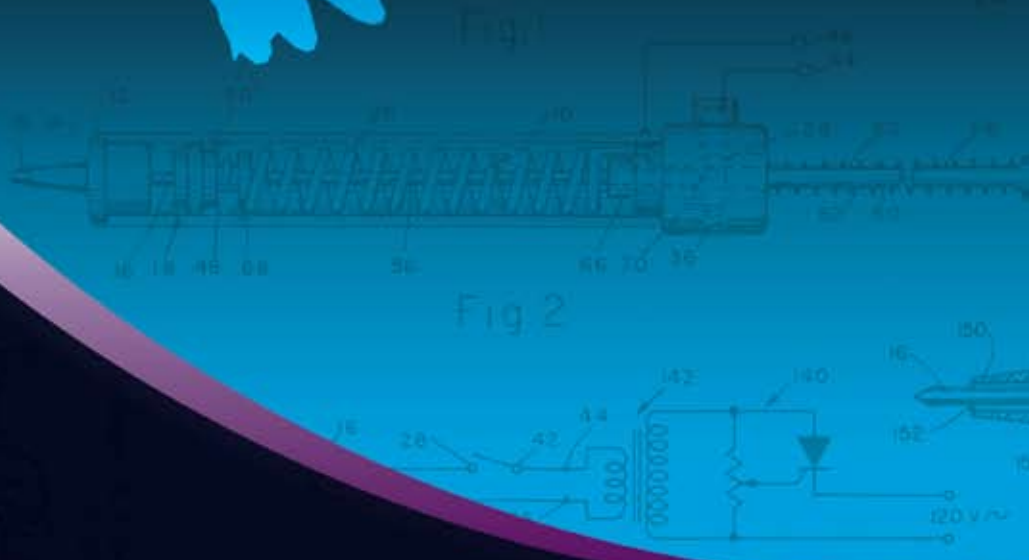

EDSYN®
...bringing innovative ideas to life

15958 Arminta Street
Van Nuys, CA 91406
tel: 818.989.2324
fax: 818.997.0895
www.edsyn.com
info@edsyn.com