

### Internal Threaded Heater Hot Air Tools and Stations

| Part No. | Description  |
|----------|--|
| 971HA    | SMT Hot Air Station  |
| 1036     | Self-Contained SMT Hot Air Station (with FAO69 Hot Air Tool) |

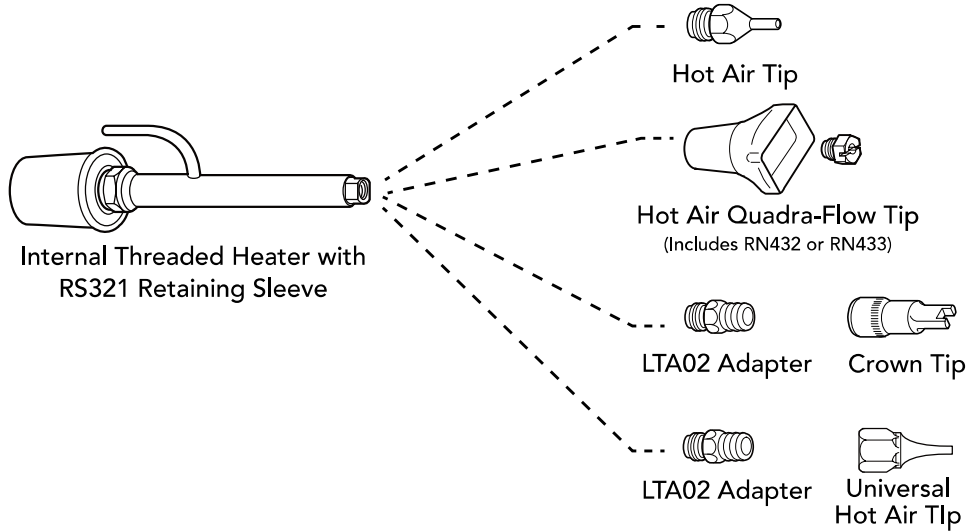

### Internal Threaded Heater Hot Air Tools and Stations

| Part No. | Description                               |
|----------|---|
| 1036DX   | Self-Contained SMT Deluxe Hot Air Station |

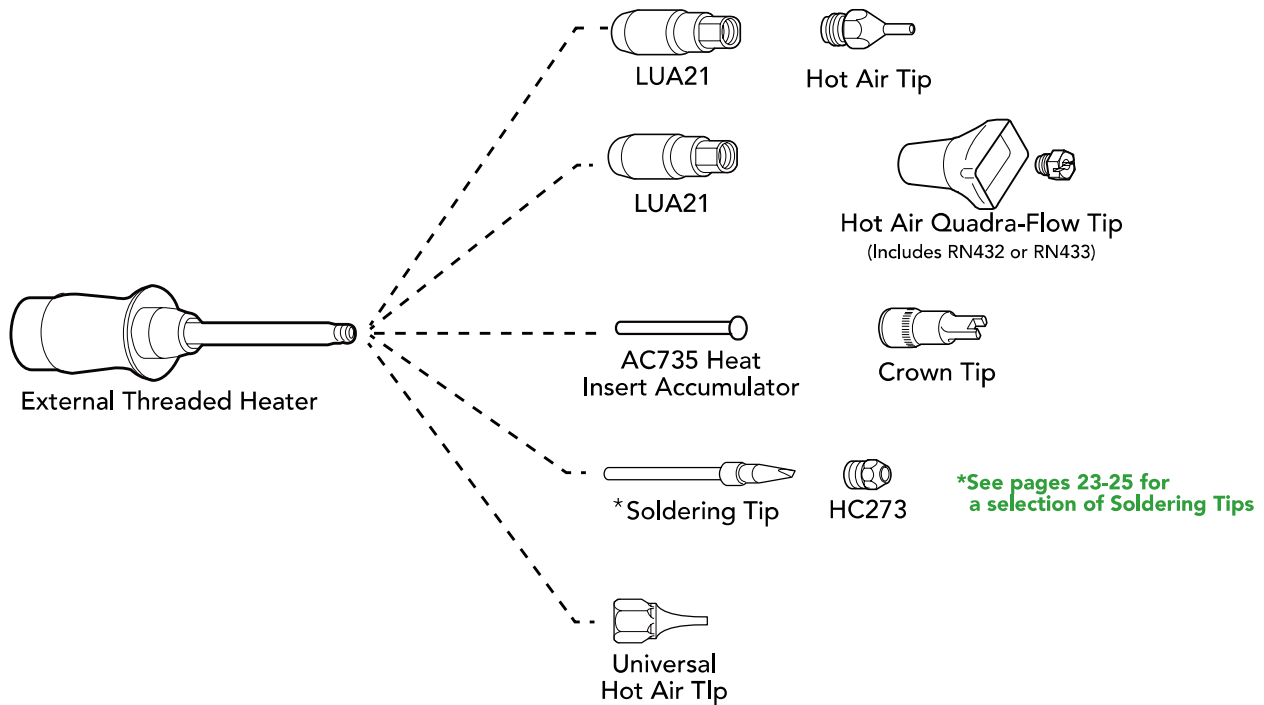



## Single Nozzle Tips



| Part No. | Tip Image | Hole Dia. A  | Length B     |
|----------|-----------|--------------|--------------|
| LT427    |           | .02" (0.5mm) | .38" (95mm)  |
| LT428    |           | .06" (1.5mm) | .25" (6.4mm) |
| LT432    |           | .04" (1.0mm) | .06" (1.5mm) |
| LT514    |           | .10" (2.5mm) | .25" (6.4mm) |

## Fan Tips

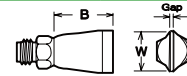

| Part No. | Tip Image | Gap          | Width W       | Length B      |
|----------|-----------|--------------|---------------|---------------|
| LT426    |           | .02" (0.5mm) | .30" (7.6mm)  | .17" (4.3mm)  |
| LT434    |           | .02" (0.5mm) | .46" (11.7mm) | .23" (5.8mm)  |
| LT435    |           | .02" (0.5mm) | .59" (15.0mm) | .35" (8.9mm)  |
| LT436    |           | .02" (0.5mm) | .65" (16.5mm) | .43" (10.9mm) |

## Dual Flow Tips

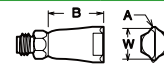

| Part No. | Tip Image | Hole Dia. A  | Width W       | Length B      |
|----------|-----------|--------------|---------------|---------------|
| LT526    |           | .03" (0.8mm) | .12" (3.0mm)  | .30" (7.6mm)  |
| LT534    |           | .05" (1.3mm) | .20" (5.1mm)  | .46" (11.7mm) |
| LT535    |           | .05" (1.3mm) | .28" (7.1mm)  | .59" (15.0mm) |
| LT536    |           | .05" (1.3mm) | .35" (8.9mm)  | .65" (16.5mm) |
| LT537    |           | .05" (1.3mm) | .44" (11.2mm) | .80" (20.4mm) |



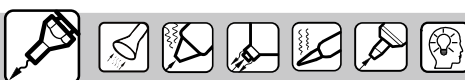

## Curl/Bent Tips

| Part No. | Tip Image | Hole Dia.    | Nozzle Length                    |
|----------|-----------|--------------|----------------------------------|
| LT510    |           | .02" (0.5mm) | .65" (16.5mm)                    |
| LT511    |           | .06" (1.5mm) | .65" (16.5mm)                    |
| LT512    |           | .07" (1.8mm) | .90" (22.9mm)                    |
| LT513    |           | .10" (2.5mm) | .90" (22.9mm)                    |
| LT571    |           | .04" (1.0mm) | 1.10" (27.9mm)                   |
| LT572    |           | .04" (1.0mm) | MAX. GAP WIDTH<br>1.25" (31.8mm) |

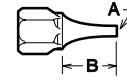

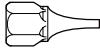

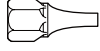

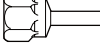
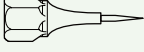
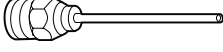
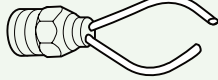

## Universal Hot Air Tips

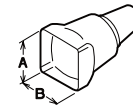

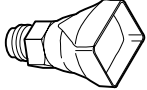
| Part No. | Tip Image  | Hole Dia A    | Length B                         |
|----------|--|---------------|----------------------------------|
| LU25     |   | .03" (6.4mm)  | .25" (6.4mm)                     |
| LU26     |   | .04" (6.4mm)  | .25" (6.4mm)                     |
| LU27     |   | .06" (6.4mm)  | .25" (6.4mm)                     |
| LU28     |   | .09" (6.4mm)  | .25" (6.4mm)                     |
| LU29     |   | .05" (7.5mm)  | .29" (7.5mm)                     |
| LU30     |   | .05" (17.8mm) | .70" (17.8mm)                    |
| LU571    |   | .04" (27.9mm) | 1.10" (27.9mm)                   |
| LU572    |  | .04" (1.0mm)  | MAX. GAP WIDTH<br>1.25" (31.8mm) |

## SMD Quadra Flow Hot Air Tips



| Part No. | Package            | Tip Image   | Width A       | Length B      |
|----------|--------------------|---|---------------|---------------|
| LT447    | SO-8               |  | .16" (4.0mm)  | .20" (5.1mm)  |
| LT448    | SO-14              |  | .21" (5.3mm)  | .35" (8.9mm)  |
| LT449    | SO-16              |  | .26" (6.6mm)  | .41" (10.4mm) |
| LT450    | SO-16L             |  | .42" (10.7mm) | .43" (10.9mm) |
| LT451    | SO-18L             |  | .44" (11.2mm) | .48" (12.2mm) |
| LT452    | SO-20L             |  | .38" (9.5mm)  | .52" (13.2mm) |
| LT454    | SO-28L             |  | .43" (10.9mm) | .73" (18.6mm) |
| LT455    | PLCC-20            |  | .40" (10.2mm) | .40" (10.2mm) |
| LT456    | PLCC-28            |  | .50" (12.7mm) | .50" (12.7mm) |
| LT458    | PLCC-44<br>LCCC-44 |  | .70" (17.8mm) | .70" (17.8mm) |