



Dremel Product Catalogue



CONTENTS

| | |
|-------------------------------|----|
| Multi-Tool System | 4 |
| Multi-Tools - Corded | 5 |
| DREMEL Stylo+ | 5 |
| DREMEL 3000 | 5 |
| DREMEL 4000 | 6 |
| DREMEL 4300 | 6 |
| Multi-Tools - Cordless | 7 |
| DREMEL 8220 | 7 |
| DREMEL Lite | 7 |
| Pet Nail Grooming Kit | 8 |
| Multi-Tool Accessories | 9 |
| Carving / Engraving / Routing | 10 |
| Grinding / Sharpening | 11 |
| Cleaning / Polishing | 11 |
| Cutting | 12 |
| Sanding | 14 |
| Miscellaneous | 15 |
| DREMEL Innovation - EZ System | 16 |

CONTENTS

| | |
|---------------------------------------------------------------|----|
| Multi-Tool Attachments | 17 |
| Workstation, Flex-Shaft, Flex-Shaft Tool Holder | 17 |
| Plunge Router, Multipurpose and Wall Tile Cutting Kits | 18 |
| Wall & Floor Grout Removal Kit, Right Angle, Shaping Platform | 19 |
| Detailers Grip, Mini Saw, Chainsaw Sharpening | 20 |
| Line & Circle Cutter, Multi-Vise | 21 |
| Compact Tool System | 22 |
| Compact Tools | 23 |
| DREMEL Versa | 23 |
| DREMEL Versatip | 23 |
| DREMEL Versaflame | 24 |
| DREMEL Glue Gun 940 | 24 |
| DREMEL Glue Gun 930 | 25 |
| DREMEL Glue Gun 910 | 25 |
| DREMEL Engraver | 26 |
| DREMEL DSM20 | 26 |
| Compact Tools Accessories & Attachments | 27 |
| Versa Accessories | 27 |

CONTENTS

| | |
|---------------------------------------------|-----------|
| Versatip, Versaflame & Engraver Accessories | 29 |
| Gluegun Accessories | 30 |
| DSM20 Accessories | 30 |
| DSM20 Attachments | 31 |
| Benchtop Tool System | 32 |
| DREMEL Moto-Saw | 33 |
| DREMEL Fortiflex | 33 |
| Benchtop Tools Accessories | 34 |
| Moto-Saw Accessories | 34 |
| Inspiration | 35 |
| Notes | 36 |
| Notes | 37 |
| Notes | 38 |

MULTI-TOOL SYSTEM

WHAT IS A MULTI-TOOL?

The Dremel high speed Multi-Tool is an entire system of functional options that centre around a core tool. The Dremel Multi-Tool System comprises of tools, accessories (including EZ SpeedClic) and attachments. This system makes the tool multi-functional, versatile and easy to use. Whether you are an experienced craftsman or beginner this system is perfect for anyone looking for precision for a wide variety of applications.



ACCESSORIES

Dremel offers you a wide variety of high quality accessories for different applications. To help you select the right accessories, Dremel has created a colour coding system: every colour represents a category of applications. No matter which materials you want to work with, Dremel has a solution for you. The Dremel exclusive EZ Speedclic range allows quick, easy and keyless accessory changes.



ATTACHMENTS

The Dremel line has many different attachments which makes your Dremel Multi-Tool more versatile. The Dremel attachments expand the usability of your Multi-Tool, so you can do your job with even more precision and ease. Dremel offers attachments to rout, control, cut, saw, sharpen and to reach.



MULTI-TOOLS

CORDED TOOLS

DREMEL[®] STYLO+

Versatile. Precise.
Made for creatives and crafters.

Variable speed for a wide range of application such as engraving, carving, sanding, grinding, cleaning and polishing

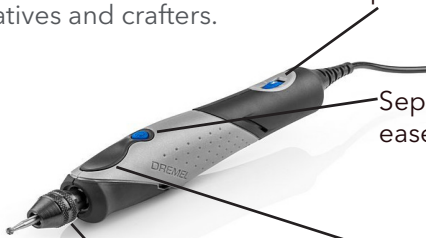

Separate on/off control for ease of use

Multichuck to quickly change accessories regardless of their size

Light weight, small with Ergonomic grip for comfort and control



DREMEL[®] 3000

Quick. Compact. All-round.

Variable speed - 10,000 - 33,000 RPM: more comfortable and better control when handling

Collet lock: for assisting accessory changes



Integrated hang hook: for hanging the tool on the tool holder or near the project

Innovate EZ Twist Nose Cap: no wrench required for changing accessories



MULTI-TOOLS

CORDED TOOLS

DREMEL 4000

Strong. Dynamic.
Maximum control.

Switch - The on/off switch is controlled separately from the rotary speed.

Scroll - Control the rotary speed from 5,000 to 35,000 RPM with the fully variable speed dial for maximum precision

EZ Twist - No wrench required for changing accessories



Motor - Finish even the most demanding precision DIY jobs with ease with the 175 W motor

Electronic Feedback - Gives extra power when needed to maintain maximum performance



DREMEL 4300

Luminous. Limitless. Max power.

The soft and secure grip reduces vibrations to allow you to work for longer and with greater manoeuvrability

With a fully adjustable LED light you can complete your tasks in those difficult corners and dark areas with full visibility



Improved fan design means a quieter and cooler environment while you are completing your projects

The integrated Multi-Chuck helps to change accessories with ease regardless of the diameter of the accessory



MULTI-TOOLS

CORDLESS TOOLS

DREMEL 8220

Cordless. Luminous. Max power.

The separate on / off switch with collet protection prevents accidental activation of the collet lock

360° rotatable LED light - for a clear view, even in dark areas

Innovate EZ Twist Nose Cap: no wrench required for changing accessories

Complete demanding DIY projects with ease - thanks to the compact, powerful 12 V Li-Ion battery with only 1 hour charging time. From 5,000 RPM to 35,000 RPM

Recognize the charging status of your tool at a glance from the battery display with 3 LEDs

Integrated with direct stop functionality so the motor stops directly once you turn it off



DREMEL LITE

Easy-to-use. Versatile. Use anywhere.

Easily adjust between the four different speeds with the variable slide switch. 8,000 - 25,000 RPM

Innovate EZ Twist Nose Cap: no wrench required for changing accessories

The ergonomic 360-degree soft grip provides comfort and precision as well as the cordless design

The battery indicator light notifies you when the battery needs to be charged. Recharge with the USB charger and dedicated plug 

The 3.6V rechargeable lithium-ion battery (2Ah) provides cordless convenience & peak performance

Compact due to its small size and low sound making it ideal for lighter duty applications



PET GROOMING TOOL

CORDLESS TOOLS

DREMEL

Pet Nail Grooming Kit

Safe and quiet pet nail grinder.

The nail dust guard allows for limited mess as it catches the dust as the nail is grinded



Covers all rotating parts for safe use

Use everywhere, operates on 4 AA batteries (excluded)

Smooth finish with no risk of cutting too deep. Includes replenishable sanding discs

Easy to use with two operating speeds

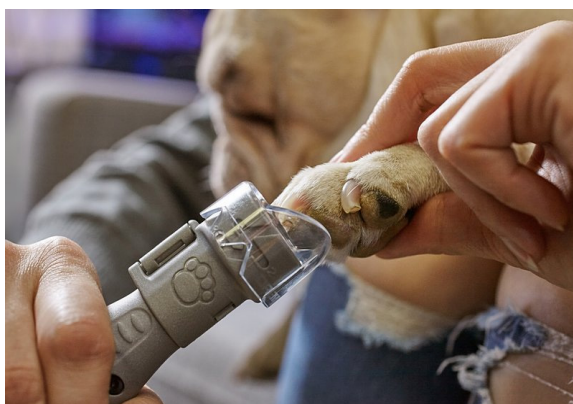

DREMEL MULTI-TOOL ACCESSORIES

CARVING / ENGRAVING / ROUTING

Dremel offers high quality carving, engraving and routing accessories for many different applications. Carving and engraving bits are the largest category of Dremel accessories. Their overall sharpness and durability allow them to last a long time when used properly. Router bits are used for edging and grooving wood, and making things like letter signs and picture frames.

GRINDING / SHARPENING

The accessories in this category have many practical, do-it-yourself applications. They accomplish the everyday, money-saving things like sharpening mower blades, boat propellers and chainsaw blades. They can also deburr, smooth, grind and clean a variety of materials around the home and garden.

CLEANING / POLISHING

Dremel cleaning and polishing accessories include brushes, felt accessories and rubber points to work on steel, aluminium, brass, silver, gold and plastics.

CUTTING

Dremel provides two types of cutting accessories for any cutting job; Cut-off wheels and cutting bits.

Cut Off wheels Make it easy to cut or slot bolts, screws, sheet metal, thin wood and plastic. Fiberglass reinforced cut-off wheels are for tough application.

Cutting bits are used with the Dremel cutting guide and cut in a manner similar to spiral saw blades in any direction.

SANDING

Dremel sanding accessories include sanding drums, bands, discs, flapwheels and abrasive buffs to remove and smoothen material.

COLLETS / MANDRELS / MISCELLANEOUS

This category features the miscellaneous extras, like drill bits, collets, mandrels and a multi-chuck. Mandrels are used to mount different accessories, like felt polishing wheels or cut-off wheels. Collets offer the most precise way to hold an accessory in a Multi-Tool. Even at high speeds, under maximum pressure, collets will stay tight.

MULTI-TOOL ACCESSORIES

CARVING / ENGRAVING / ROUTING

1. High Speed Cutters

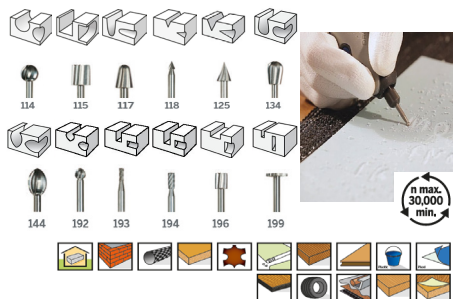

2. Engraving Cutters

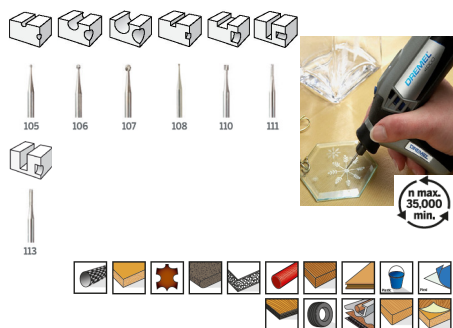

3. Diamond Tips

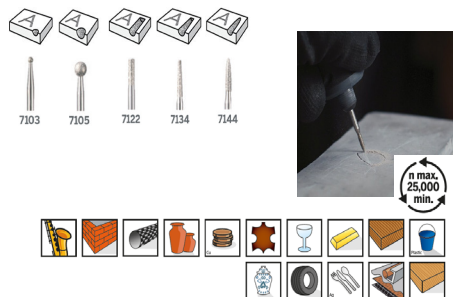

4. Tungsten Carbide Cutters

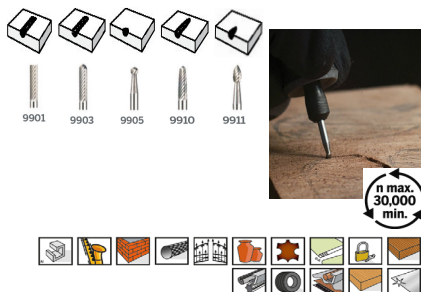

5. Tungsten Carbide Toothed Cutters

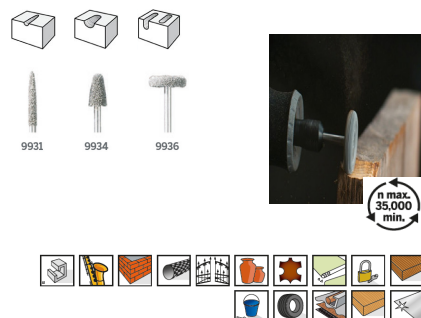

6. Routers (HSS)

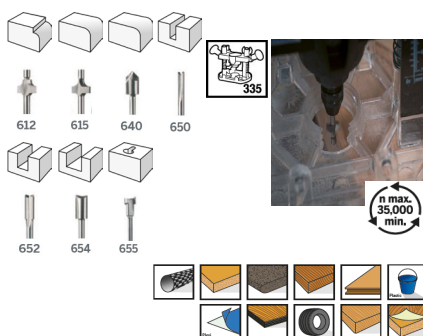

MULTI-TOOL ACCESSORIES

GRINDING / SHARPENING

1. Dremel EZ SpeedClic: Grinding Wheel



SC341



DREMEL EZ
SpeedClic



n max.
35,000
min.



2. Aluminum Oxide Grinding Stones



n max.
25,000
min.



3. Aluminum Oxide Abrasive Point



516



n max.
20,000
min.



4. Silicon Carbide Grinding Wheels

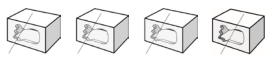

83322

84922

85422

85602



n max.
25,000
min.



5. Chainsaw Sharpening Stones



453

454



1453



455

457



n max.
30,000
min.

CLEANING / POLISHING

1. Rubber Polishing Point



462



n max.
30,000
min.



MULTI-TOOL ACCESSORIES

2. Impregnated Polishing Wheel



3. Polishing Discs



4. Wire and Steel Brushes



5. High-Performance Abrasive Brush



6. Stainless Steel and Brass Brushes

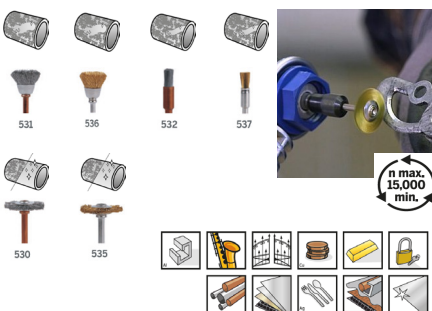

CUTTING

1. Dremel EZ SpeedClic: Starter Set and Cutting Discs

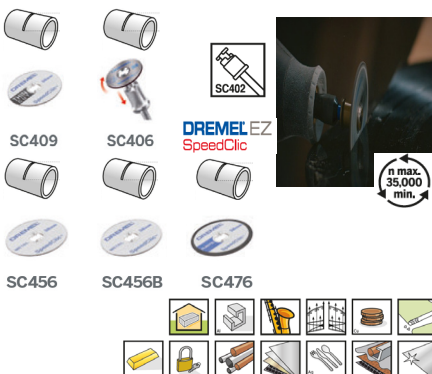

MULTI-TOOL ACCESSORIES

2. Dremel EZ SpeedClic: Cutting Disc for Wood



3. Dremel EZ SpeedClic: Diamond Cutting Disc

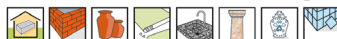

4. Cutting Discs

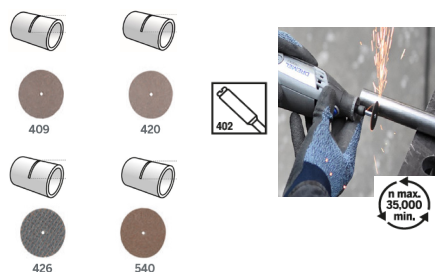

5. Cutting / Shaping Wheel

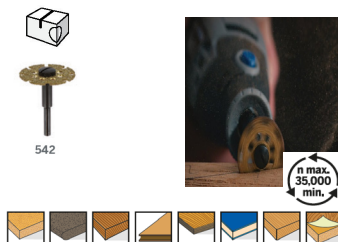

6. Rib / Cross-Cut Blade

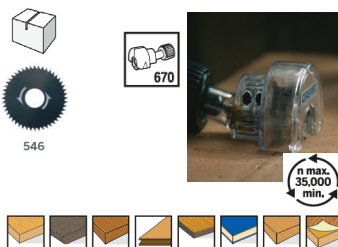

7. Spiral Cutting Bits



8. Cutters for Grout Removal



MULTI-TOOL ACCESSORIES

SANDING

1. Dremel EZ SpeedClic: Detail Abrasive Brushes

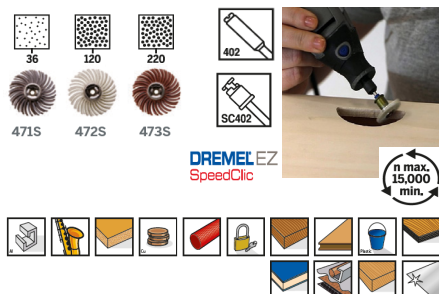

2. Dremel EZ SpeedClic: Finishing Abrasive Buffs

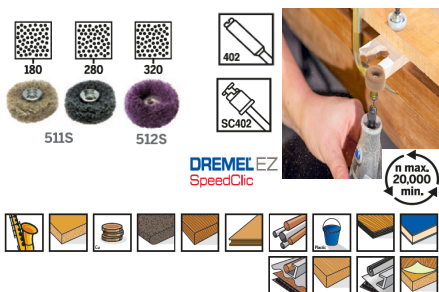

3. Dremel EZ SpeedClic: Sanding Mandrel and Sanding Bands



4. Sanding Bands

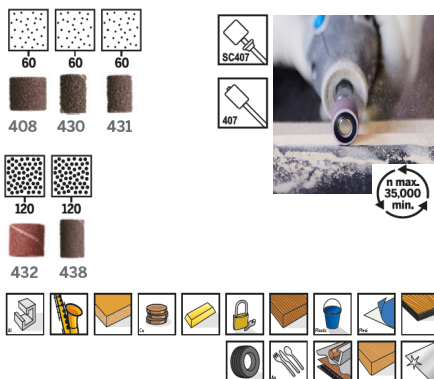

5. Dremel EZ SpeedClic: Abrasive Discs

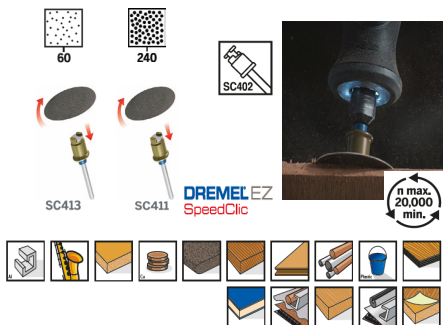

6. Flap Wheels

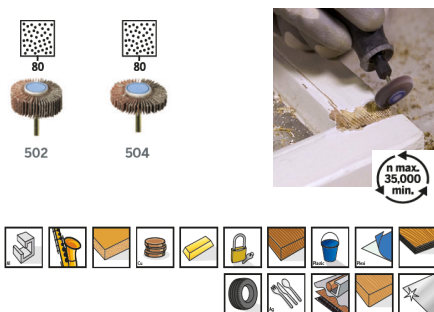

MULTI-TOOL ACCESSORIES

MISCELLANEOUS

1. Glass Drilling Bits

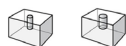

662

663



n max.
35,000
min.

2. Collet Nuts, Mandrels and Chuck



4485

4486



401

402

SC402

DREMEL EZ
SpeedClic



n max.
35,000
min.

3. Precision Drilling



628



n max.
20,000
min.

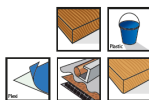

3. Precision Drilling



636

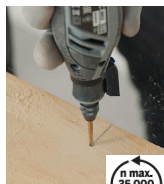

n max.
35,000
min.

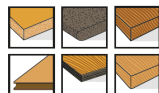

MATERIAL ICONS

| | | | | | |
|--|------------------------|--|-----------------|--|---------------------------------|
| | Soft Wood | | Aluminium | | Cast Iron |
| | Hard Wood | | Marble | | Steel Profiles |
| | Plywood | | Granite | | Steel - General |
| | Laminates | | Glass | | Grout |
| | Chipboard | | Plexiglass | | Glass Fibre Reinforced Plastics |
| | Fiberboard | | Plastic | | Foam Boards |
| | Wall Tile | | Carbon | | Sheet Metal |
| | Brick | | Epoxy | | Leather |
| | Porcelain | | Rubber | | Veneered Woods |
| | Drywall / Plasterboard | | Soft Metal | | Sandwich Material |
| | Aerated Concrete | | Brass | | Chainsaw Chain |
| | Ceramic | | Hardened Steel | | Metal Pipes |
| | Silver | | Gold | | |
| | Copper | | Stainless Steel | | |

DREMEL INNOVATION - EZ SYSTEM

EZ SPEEDCLIC

EZ SpeedClic is Dremel's unique quick-change system for rotary tool accessories. The high quality EZ SpeedClic accessories allow for quick, easy and keyless accessory changes, which means less time changing accessories and more time to work on your project for faster completion. These accessories are available for a wide range of applications from cutting to sanding and can be used in a diverse range of materials.



DREMEL EZ SpeedClic



EZ TWIST

There is no need for a wrench to tighten and loosen the collet when changing accessories, the wrench mechanism is integrated in the nose cap of the tool.



MULTI-TOOL ATTACHMENTS

Workstation (220)



The combined Drill Press and Tool Holder is the perfect solution for stationary working with your Dremel at any angle you want to.

- Holds tool horizontally for polishing, grinding and sanding
- A holder for the tool to use without flex shaft
- Accessory storage
- Depth markings for consistent depth adjustment



Flex-Shaft (225)

Ideal attachment for precise, detailed work or hard to reach places. Comfort grip handpiece allows fingertip control to carve, engrave, cut, grind, sand, polish and more. More comfort and less fatigue in longer lasting projects due to small hand piece.



- Integrated shaft lock button for quick and easy accessory changes.
- Comfort and flexibility during use.
- Quick connect attaches your Dremel tool in seconds.



Flex-Shaft Tool Holder (2222)

Conveniently suspends your Dremel Multi-Tool above your workbench. Perfect for use with the Flexible Shaft attachment.

- Clamps to workbenches up to 42 mm thick, and adjusts in height from 300 to 1070 mm.
- Store extra bits on base.



MULTI-TOOL ATTACHMENTS

Plunge Router (335)

Converts your Dremel tool into a plunge router to rout circles, signs and inlay work, decorative edges and to rout parallel to an edge.



- Plunge-lock in handle - simply turn handle to lock/unlock.
- User can define fully variable depth stops for quick, consistent adjustment of depth.
- Edge guide and circle guide to rout straight lines and perfect circles.



Multipurpose Cutting Kit (565)

Provides controlled cutting in a variety of materials in any direction.



- Easily attaches to your Dremel tool.
- Easy depth adjustment up to 19 mm material thickness.



Wall Tile Cutting Kit (566)

Provides controlled cutting in ceramic wall tiles in any direction.



- Easily attaches to your Dremel tool.
- Easy depth adjustment up to 19 mm material thickness.



MULTI-TOOL ATTACHMENTS

Wall & Floor Grout Removal Kit (568)



Specially developed for removing grout from between wall and floor tiles.

The risk of chipping your tiles is greatly reduced compared with manual chiseling.

- Easy depth adjustment.
- Guide keeps bit centered between tiles.

For compatibility please check the compatibility overview on the rear of the packaging.



Right Angle Attachment (575)



Designed to use accessories in right angle for hard to reach places.

- Ball bearings and bevel gears provide smooth and cool operation and guarantee longer lifetime.
- Coupling system allows to place the attachment in 12 different directions on your Dremel tool.
- Quick connect attaches your Dremel tool in seconds.

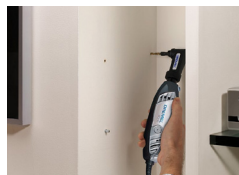

Shaping Platform (576)



The Dremel Shaping Platform enables you to sand and grind at perfect 90 and 45 degree angles.

With the included sanding mandrel, sanding band and grinding stone you can start working straight away.



MULTI-TOOL ATTACHMENTS



Detailer's Grip (577)

The Dremel Detailer's Grip attachment enables you to have even better control of your Multi-Tool when doing DIY, hobby and craft projects.

With the included stencil template and engraving cutter you can begin working with the detailer's Grip attachment and your Multi-Tool straight away.



Mini Saw Attachment (670)

Transforms your Dremel tool into a precision circular saw for fine, clear and straight cuts in all sorts of wood with a max working depth of 6.4 mm.

- Perfect for laminate and wood flooring or thin wood plates.
- The safety guard and lower guard makes it safe to use.
- The guide allows to make straight cuts.
- This Mini Saw Attachment is easier to use than a hand saw, more precise than a jig saw and fits in tighter spaces than a circular saw.



Chainsaw Sharpening Attachment (1453)

The fastest, easiest way to sharpen dull, slow-cutting chain saws.

- Easily attaches to your Dremel tool.
- Works with a variety of different chain sizes.

For compatibility please check the compatibility overview on the rear of the packaging.



MULTI-TOOL ATTACHMENTS

Line & Circle Cutter (678)



Makes perfect holes and straight cuts and easily connects to your Dremel tool

- Included cutting bits are perfect for cuts in drywall, wood and laminate
- Maximum cutting diameter is 30 cm.



Multi-Vise (2500)



The Dremel 3-in1 Multi-Vise. Stationary vise, stand alone clamp & Toolholder.

Clamps to any workbench, table or countertop

- Rotates 360° and tilts 50°. Allows approaching the workpiece from a comfortable angle.
- Jaws may be used with base unit or detached for use as a stand-alone bar clamp.

- Easily accommodates larger work pieces. Stabilises oversized objects and protect delicate pieces from damage.

- Allows round and odd-shaped objects to be held securely.
- Allows quick removal of objects from jaws.



COMPACT TOOL SYSTEM

WHAT IS A COMPACT TOOL?

Our compact tool system consist of many tools to help you tackle your DIY, cleaning and creative projects. From soldering to gluing to cutting, the possibilities are endless. This system includes the Dremel Versa which is our High Speed Power Cleaner functioning as an oven cleaner, bathroom tile or shower glass cleaner, shoe cleaner and much more.



ACCESSORIES

For every compact tool, whether it's the Versa cleaning tool, to the glue gun, we have accessories for almost all materials / applications you want to do.



ATTACHMENTS

In the Compact Tool System, we offer a small range of one attachment which is for the DSM20. The Cutting Guide. This attachment helps to enhance the cutting capabilities of the Dremel DSM20.



COMPACT TOOLS

DREMEL VERSA

High Speed Power Cleaner - All your Cleaning Supplies in One

Easy power button
The Versa is designed to shut off if too much pressure is applied

Versatile
Perfect for both wet and dry uses



USB charging system
A blue light will illuminate while charging, which will turn off once fully charged



Easy pad changing system
Align either the backing pad or the brush to the threads on the tool and turn clockwise. For use of a cleaning pad, press the loop side of the pad to the base of the backing pad

DREMEL VERSATIP

Butane iron - The cordless 6-in-1 gas-torch for hot cutting, soldering, pyrography and more



Flame lock-on mechanism
keeps the torch on a continuous flame

Refillable tank
Powered by liquid butane lighter fuel, full tank can burn for up to 75 minutes

Integrated ignition trigger
With safety lock for easy start up



Cordless
ideal for hobby & craft projects

6 accessories included

COMPACT TOOLS

DREMEL VERSAFLAME

Butane torch - The most versatile stationary burner for both DIY and hobby projects



Butane torch flame allows for detailed open flame work

Cordless or stationary heat gun with detachable foot, use anytime anywhere

Safest mini blow torch with flame lock button for continuous hands-free use and child safety lock mechanism

Gas torch tank capacity of 22 g - longer use, full tank lasts up to 75 minutes at maximum capacity.

Temperature:
1200C (open air)
680 - 1000C (hot air)
550C (tips)

DREMEL GLUE GUN 940

High temperature glue gun - For all indoor and outdoor DIY applications with the biggest glue output

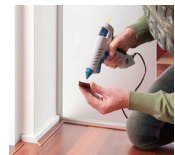
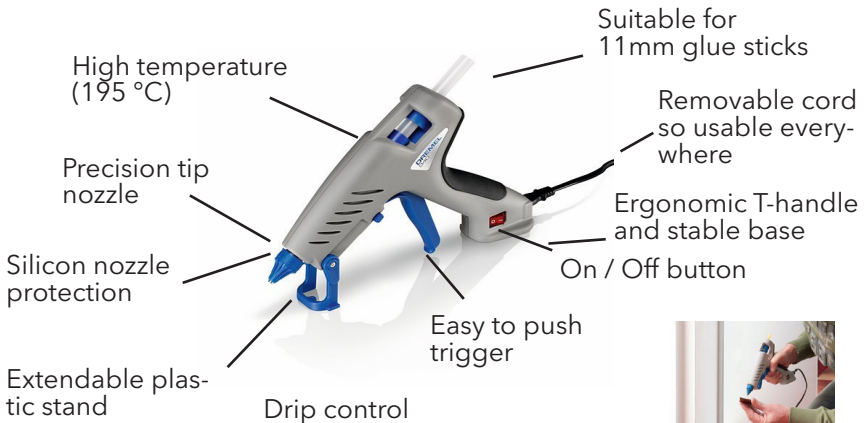

COMPACT TOOLS

DREMEL GLUE GUN 930

Dual temperature glue gun - Bring your creativity to the next level with colourful and precise gluing



DREMEL GLUE GUN 910

Compact glue gun - For intricate and quick gluing in all light DIY jobs

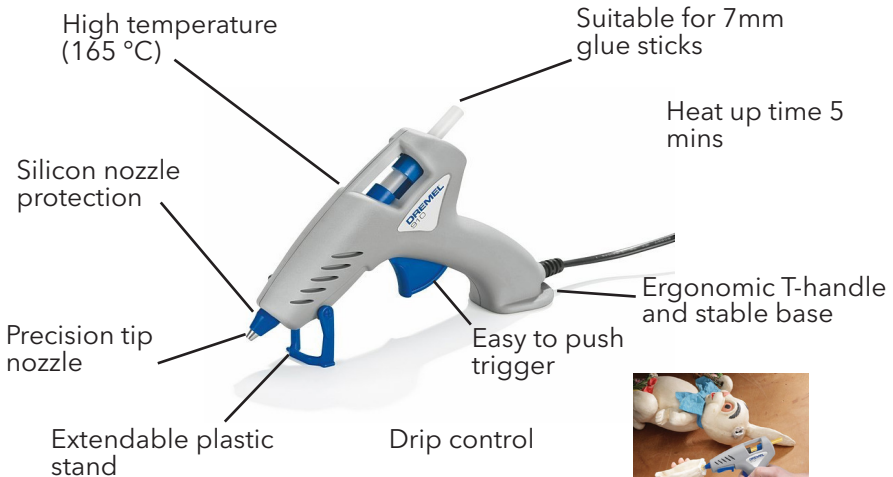

COMPACT TOOLS

DREMEL ENGRAVER

Engraver - Precisely engrave a wide variety of materials with optimal depth control



DREMEL DSM20

Compact saw - For precise, clean and straight cuts with clear line of sight



COMPACT TOOLS - ACCESSORIES & ATTACHMENTS

VERSA ACCESSORIES

Kitchen Scour Pad (PC367)

The Kitchen Scour Pad is ideal for removing dirt and food residue from pots and pans and other surfaces.



Polishing Pad (PC366)

Multipurpose Polishing Pad perfect for gently polishing metals, leather and more without leaving any scratches.



Extreme Scour Pad (PC368)

The Extreme Scour Pad is perfect for cutting through and removing tough stuck-on messes.



Foam Pad (PC362)

Multi-purpose accessory for hard surfaces including counter tops, floors, doors, walls, shoes and more.



COMPACT TOOLS - ACCESSORIES & ATTACHMENTS

VERSA ACCESSORIES

Non-Scratch Pad (PC363)

Great for surfaces that require scrubbing without scratching, such as pots, pans, sinks, drains, tubs and more.



Bristle Brush (PC364)

Perfect for detailed areas or objects that require heavy-duty cleaning, such as grout, grill exteriors, car interiors, exteriors and more.



Heavy Duty Pad (PC361)

Aggressively removes stubborn scum and baked-on food, as well as small surface scratches on your wood furniture.



COMPACT TOOLS - ACCESSORIES & ATTACHMENTS

VERSATIP & VERSAFLAME ACCESSORIES



Soldering Tip 201

Used to solder, weld, carve, engrave in various materials such as wood, leather and different metals.

The fine point of the tips allow for more precision and control in your soldering work

* Compatible with the VERSAFLAME



Cutting Knife 202

Ideal for cutting, carving and burning decorative designs in wood and leather. Other materials include cutting rope, wax, soap, and foam board.



Pyrography set 204

Versatip pyrography tip set can be used to apply different pyrography motifs onto wood and leather. Applications include engraving, drawing, shading, striping and calligraphy.



ENGRAVER ACCESSORIES



Carbide Engraving Tips 9924

Designed for normal engraving applications
Create fine lines to deep grooves



Diamond Engraving Point 9929

Designed for hard-surface engraving applications
and continuous use



COMPACT TOOLS - ACCESSORIES & ATTACHMENTS

GLUEGUN ACCESSORIES

7mm & 11mm Glue Sticks



GG01 - 7 mm Multipurpose High Temp Glue Sticks



GG02 - 7mm Multipurpose Low Temp Glue Sticks



GG03 - 7mm Wood Glue Sticks



GG40 - Glue Pad
A flexible heat resistant mat that can be used to catch excessive glue and to create decorative glue design patterns: allow glue to cool and peel it off easily.



GG11 - 11 mm Multipurpose High Temp Glue Sticks



GG13 - 11 mm Wood Glue Sticks



GG05 - 7 mm Colour Sticks

DSM20 ACCESSORIES



Metal and Plastic Cutting Wheel (DSM510)

The DSM510 is a reinforced type 1 abrasive cutting wheel which is designed to cut a variety of materials such as metal and plastic.



Diamond Tile Cutting Wheel (DSM540)

The DSM540 is a diamond abrasive wheel which is designed for cutting hard materials such as marble, concrete, brick, porcelain and ceramic tile.



COMPACT TOOLS - ACCESSORIES & ATTACHMENTS



Multipurpose Carbide Flush Cutting Wheel (DSM600)

The DSM600 is a multipurpose carbide flush cutting wheel. This offset abrasive cutting wheel with carbide grit is designed to cut (straight, plunge and flush) wood and other soft materials.



Multipurpose Carbide Cutting Wheel (DSM500)

The DSM500 is a multipurpose carbide cutting wheel. This abrasive cutting wheel with carbide grit is designed for doing straight and plunge cuts in wood and other soft materials.



Masonry Cutting Wheel (DSM520)

The DSM520 is a masonry cutting wheel. This reinforced type 1 abrasive cut-off wheel is intended to make cuts in masonry and stone.

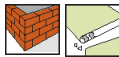

DSM20 ATTACHMENT



Cutting Guide (DSM840)

This attachment helps to enhance the cutting capabilities of the Dremel DSM20. Mitre, bevel and straight cuts are easily achieved in base-board, trim or molding using the DSM840 Cutting Guide.



BENCHTOP TOOL SYSTEM

WHAT IS A BENCHTOP TOOL?

Dremel's benchtop tools help to provide more comfort and ease whilst getting the hardcore jobs done.

Whether its cutting a piece of wood in half or tackling a project that requires both power and precision, the Benchtop tools are an essential to your tool box.



ACCESSORIES

Offering blades to cut both metal and wood, the Moto-Saw accessories are great for detailed and straight cuts with 4 accessories to choose from!

Multi-Tool accessories are compatible with the Dremel FortiFlex. Making it ideal to use in any project that you need. From sanding to engraving with complete ease.

FORTIFLEX

The Dremel Fortiflex is a high quality precision tool, consisting of a powerful hanging motor (300W), a patented heavy duty flexible shaft, an exchangeable precision hand piece and a foot pedal for variable speed control (0-20.000rpm). This makes it the ideal tool for stationary projects, like woodworking, jewellery making, stone working, car restoration, or any project where a combination of power and precision is required. The Dremel Fortiflex: power meets precision.

MOTO-SAW

The Dremel Moto-Saw is a compact and easy-to-use scroll saw for making detailed cuts in different materials. With its range of different saw blades, the Dremel Moto-Saw can handle many different materials easily. Thanks to its detachable fretsaw, it can be used not only stationary but in-hand anywhere. This userfriendly scroll saw is not only easy to store and set-up, but also easy to operate. The Dremel Moto-Saw is the most user-friendly scroll saw.



BENCHTOP TOOLS

DREMEL MOTO-SAW

Compact scroll saw with detachable fretsaw - Make detailed cuts easily

Dust port adapter keeps line-of-sight clear and work space clean

Auto tensioning quick-change mechanism for easy accessory change and optimal blade tensioning

Fast-clamp base attaches to various tables, benches and surfaces

Detachable coping function for handheld use to take the tool to the work piece

Variable-speed control for optimal cutting in a variety of materials



DREMEL FORTIFLEX

Heavy duty flexible shaft - Work precisely for extended periods of time with complete control over your stationary projects

High torque in lower speed range

High powered 300W motor with variable speed 0 - 20,000rpm

Variable shank diameter (0.3 - 4.0mm) is suitable for all high quality Dremel accessories

Separate foot pedal for single-handed use with anti-slip strips on bottom

Ultimate precision through low collet run-out

Variable speed control through foot pedal



BENCHTOP TOOLS - ACCESSORIES

MOTO-SAW ACCESSORIES

Fine Wood Cutting Saw Blade (MS52)

Saw blade for detailed cuts in wooden materials. This blade has 7 teeth per centimeter ensuring the finest cutting results.



General Purpose Wood Cutting Saw Blade (MS51)

Saw blade for straight and large diameter curved cuts in wooden and plastic materials. This blade has 6 teeth per centimeter ensuring a good balance between speed and precision.



Metal Cutting Saw Blade (MS53)

Saw blade for cutting soft sheet metal. This blade has 10 teeth per centimeter ensuring excellent cuts.



Side Cutting Saw Blade (MS50)

Saw blade for longer cut offs, which are normally limited by the throat depth of the tool. In terms of technical specifications, this blade is identical to the MS51 General Purpose blade, however, its top and bottom parts are 90 degrees twisted. This twist allows a lateral material feed either from left or right, resulting in technically infinite cuts.



INSPIRATION

From detailed product information to project inspiration, you'll find everything on our website and social channels!

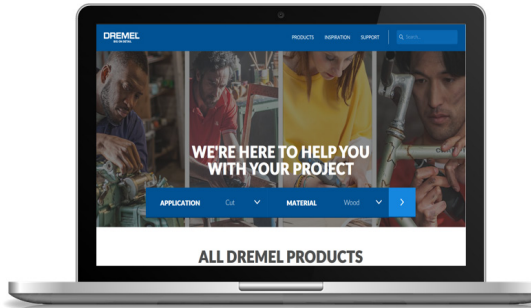

WWW.DREMEL.COM

 **Dremel**

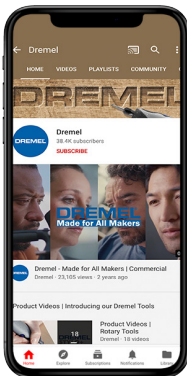

 **@Dremel_ea**

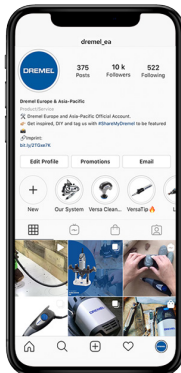

 **Dremel**

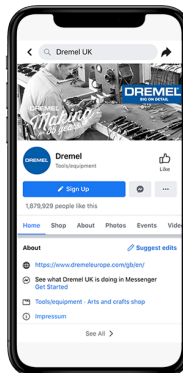

 **#Dremel**

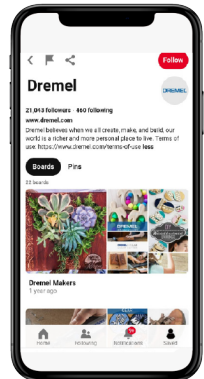

NOTES

DREMEL®