



ASG-SD2500 & ASG-CT2500
ASG-SD2500 Series Screwdriver & Controller

User's Guide

Version 3.0.6

December, 2022



Document CT2500-1 EN

Original Instructions

ASG Precision Fastening ASG-CT2500 User's Guide

Version 3.0.6

Major Revision: December, 2022

GUI Firmware v3.x.x.x +

To download the latest version of this manual visit:

www.asg-jergens.com

ASG Precision Fastening

(888) 486-6163

15700 S. Waterloo Rd.

Cleveland, OH 44110

USA

© 2022 Jergens Inc.

All Rights Reserved

Table of Contents

Declaration of Conformity	5
Information on Noise Emission	7
Information on Transmitted Vibration	7
Safety Precautions	8
Introduction	11
Installation	13
Controller & Power Requirements	13
Tool	14
Pistol Grip Assembly	15
ASG-SD2500 Functions	16
ASG-SD2500 Operations	17
Run Tool Screen	18
Tool Information Screen	20
Setup Screen	22
Tool Triggering	22
Bolt Counts	22
Bolt Retries	23
Reverse Settings	23
Parameter Setup	24
Bolt Sequences	26
Prevailing Torque	27
Prevailing Torque Link	28
Task Setup	30
Renaming and Importing Tasks	30
Exporting Tasks	31

Input Programming	32
Task Select	32
Enable Bolts	33
Remote Start	34
Reverse Select	35
Remote Reset	36
Remote Halt	37
Output Programming	38
Input/Output Port Pin Guide	40
Graph Screens	42
Graph Data Export	44
Data Screen	45
Erasing Data	45
Downloading Data	46
System Setup Screen	47
Passwords	47
Date/Time Settings	49
Tool Trigger Sensitivity	50
Tool Calibration	51
Controller Information	52
Firmware Updates	53
Touch Screen Calibration	53
LCD Brightness Adjustment	53
Service & Warranty	54

Declaration of Conformity to European Union Directives



We ASG, Division of Jergens Inc.
of 15700 S. Waterloo Rd. Cleveland, Ohio 44110 USA

in accordance with the following Directive(s):

- 2006/42/EU - on "Machinery"
- 2014/30/EU - on "Electromagnetic Compatibility"
- 2011/65/EU - on "The restriction of the use of certain hazardous substances in electrical and electronic equipment"

hereby declare that:

Equipment: ASG SD2500 Electric Screwdrivers/Nutrunners
Model numbers: ASG-SD2500-10FX, ASG-SD2500-20FX, ASG-SD2500-35FX, ASG-SD2500-50FX,
ASG-SD2500-10PS, ASG-SD2500-20PS, ASG-SD2500-35PS, ASG-SD2500-50PS,
ASG-SD2500-10PL, ASG-SD2500-20PL, ASG-SD2500-35PL, ASG-SD2500-50PL,
ASG-SD2500-10RP, ASG-SD2500-20RP, ASG-SD2500-35RP, ASG-SD2500-50RP,
ASG-SD2500-10RQ, ASG-SD2500-20RQ, ASG-SD2500-35RQ, ASG-SD2500-50RQ,
ASG-SD2500-10FX-AUTO, ASG-SD2500-20FX-AUTO, ASG-SD2500-35FX-AUTO,
ASG-SD2500-50FX-AUTO

is in conformity with the applicable requirements of the following documents

- EN 62841-1 – Electrical Motor-Operated Hand-Held Tools, Transportable Tools and Lawn and Garden Machinery – Safety - Part 1: General Requirements (2015/A11:2022)
- EN 62841-2-2 – Electrical Motor-Operated Hand-Held Tools, Transportable Tools and Lawn and Garden Machinery – Safety - Part 2-2: Particular Requirements for Hand-Held Screwdrivers and Impact Wrenches (2014/AC:2015)
- EN 61326-1: 2021 – Electrical Equipment for Measurement, Control, and Laboratory Use – Electromagnetic Compatibility (EMC) Requirements: Part 1 General Requirements (2021)
- EN 61000-4-2:2009 - Electromagnetic compatibility (EMC) - Part 4-2: Testing and measurement techniques – Electrostatic discharge immunity test
- EN 61000-4-3:2020 - Electromagnetic compatibility (EMC) - Part 4-3 : Testing and measurement techniques – Radiated, radio-frequency, electromagnetic field immunity test
- EN 61000-4-4:2012 - Electromagnetic compatibility (EMC) - Part 4-4: Testing and measurement techniques – Electrical fast transient/burst immunity test
- EN 61000-4-5:2014/A1:2017 - Electromagnetic compatibility (EMC) - Part 4-5: Testing and measurement techniques – Surge immunity test
- EN 61000-4-6:2014 - Electromagnetic compatibility (EMC) - Part 4-6: Testing and measurement techniques – Immunity to conducted disturbances, induced by radio-frequency fields
- EN 61000-4-11:2020 - Electromagnetic compatibility (EMC) - Part 4-11: Testing and measurement techniques – Voltage dips, short interruptions and voltage variations immunity tests for equipment with input current up to 16 A per phase

Person Authorized to Compile the Technical File Federico Roma
ASG, Division of Jergens Inc.
Via Vicolo Lombardo, 27
Villaverla 36030 Italy

We hereby declare that the equipment named above has been designed to comply with the relevant sections of the above referenced specifications. The apparatus complies with all applicable Essential Requirements of the Directives.

Signed by:

Name: Bryon Shafer
Position: General Manager: ASG, Division Jergens Inc.
Place: Cleveland, Ohio USA
Date: 18 November 2022

Technical File Reference: ASG-TF-SD2500-01

Declaration of Conformity to European Union Directives

We ASG, Division of Jergens Inc.
of 15700 S. Waterloo Rd. Cleveland, Ohio 44110 USA



in accordance with the following Directive(s):

2014/35/EU - on "Low Voltage"
2014/30/EU - on "Electromagnetic Compatibility"
2011/65/EU - on "The restriction of the use of certain hazardous substances in electrical and electronic equipment"

hereby declare that:

Equipment: ASG SD2500 Electric Screwdriver Controller

Model number: ASG-CT2500

is in conformity with the applicable requirements of the following documents

- EN 61010-1:2010 A1:2016/C2019 - Safety Requirements for Electrical Equipment for Measurement, Control, and Laboratory Use – Part 1
- EN 61326-1: 2021 – Electrical Equipment for Measurement, Control, and Laboratory Use – Electromagnetic Compatibility (EMC) Requirements: Part 1 General Requirements (2021)
- EN 61000-4-2:2009 - Electromagnetic compatibility (EMC) - Part 4-2: Testing and measurement techniques – Electrostatic discharge immunity test
- EN 61000-4-3:2020 - Electromagnetic compatibility (EMC) - Part 4-3 : Testing and measurement techniques – Radiated, radio-frequency, electromagnetic field immunity test
- EN 61000-4-4:2012 - Electromagnetic compatibility (EMC) - Part 4-4: Testing and measurement techniques – Electrical fast transient/burst immunity test
- EN 61000-4-5:2014/A1:2017 - Electromagnetic compatibility (EMC) - Part 4-5: Testing and measurement techniques - Surge immunity test
- EN 61000-4-6:2014 - Electromagnetic compatibility (EMC) - Part 4-6: Testing and measurement techniques – Immunity to conducted disturbances, induced by radio-frequency fields
- EN 61000-4-11:2020 - Electromagnetic compatibility (EMC) - Part 4-11: Testing and measurement techniques – Voltage dips, short interruptions and voltage variations immunity tests for equipment with input current up to 16 A per phase

Person Authorized to Compile the Technical File

Federico Roma
ASG, Division of Jergens Inc.
Via Vicolo Lombardo, 27
Villaverla 36030 Italy

We hereby declare that the equipment named above has been designed to comply with the relevant sections of the above referenced specifications. The apparatus complies with all applicable Essential Requirements of the Directives.

Signed by:

Name: Bryon Shafer

Position: General Manager, ASG, Division Jergens Inc.



Place: Cleveland, Ohio USA

Date: 12 September 2022

EMC Technical File Reference: **ASG-TF-CT2500-EMC-01**

Information on Noise Emission

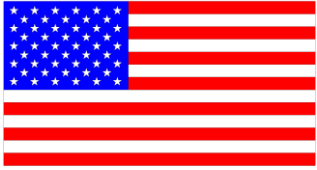
The ASG Division of Jergens Inc., Model SD2500 Electric Screwdriver Sound Pressure and Sound Power Levels per EN ISO 11202 are as follows:

Model No: ASG-SD2500	Serial No: As noted on Nameplate	Year of Construction: As noted on Nameplate	
		Operating	Idle
L_{pAm} (Operator Position)		75 dB (A)	44 dB (A)
L_{pAm} (Bystander Position)		75 dB (A)	44 dB (A)
Peak C-weighted instantaneous SPL in the Operator's position		69 dB (C)	53 dB (C)
Sound power emitted where the equivalent continuous A-weighted SPL exceeds 80 dB (A).		N/A	---
The average difference between the extraneous noise level and the sound power level at each measuring point:		$L_{pAm} \Delta = 31 \text{ dB (A)}$	
Ambient Correction Factor K3A calculated according to EN ISO 11204 Appendix A.		4 dB (A)	
Measurements were made at a height of 1.5 m and 1 m from the Operator Position and all four sides of the equipment.			
<p>The figures quoted are emission levels and are not necessarily safe working levels. While there is a correlation between the emission and exposure levels this cannot be used reliably to determine whether or not further precautions are required.</p> <p>Factors that influence the actual level of exposure of the workforce include characteristics of the work room, the other sources of noise, etc. such as the number of machines and other adjacent processes. Also, the permissible level of exposure can vary from country to country.</p> <p>This information, however, will enable the user of the machine to make a better evaluation of the hazard and risk.</p>			
	ASG, Division of Jergens Inc. 15700 S. Waterloo Rd. Cleveland, Ohio 44110 USA		

Information on Transmitted Vibration

The ASG Division of Jergens Inc., Model SD2500 Electric Screwdriver transmitted vibration levels as found according to EN ISO 60745 are as follows: **Screwdriver vibration: < 2.5 m/s²**

Safety Precautions



Be sure to read all instructions and precautions contained in this manual, failure to do so may result in personal injury and/or damage to tooling and components.



DAMAGE REQUIRING SERVICE – Unplug this product from the wall outlet and request servicing by qualified service personnel under the following conditions:

- When the power supply cord is damaged
- When the tool cable is damaged
- If liquid has been spilled onto the enclosure of the unit.
- If the product does not function normally by following the instructions in the User's Guide. Adjust only those controls that are covered by the operating instructions. Improper adjustment of the controls may result in damage and will often require rework by a qualified technician to restore the product to its normal operation.
- If the product has been damaged in any way.
- When the unit displays a negative, distinct change in performance.



Do not operate or plug in the controller/system with wet hands or in wet environments. Failure to observe this may result in injury due to electric shock.



Do not operate this equipment from any power source that does not match the voltage rating marked on the equipment. Refer to the Manufacturer's Identification Label for operational requirements.



Ensure the controller is properly plugged in to a grounded electrical receptacle. Do not remove the ground pin or use any adapter plugs.

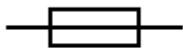

CAUTION - Replace fuse with same type and rating:
250V, 8A, Time-Lag T, 5x20mm 1kA



POWER CORD PROTECTION – The power supply cord for this product acts as the main-disconnect. It should be routed or installed in such a manner to protect it from being walked on or pinched. The unit should be powered down completely before connecting or disconnecting the power cable. The power cord should be removed before moving the unit. **The power cord must be placed near an easily accessible unobstructed socket outlet.**



TOOL CABLE PROTECTION - Tool cable must be properly routed and festooned to avoid tangling and trip hazards. It should not be installed in any manner that allows it to be walked on or pinched.



Do not use any part of the system (tool, cable, or controller) for anything other than its specified application. Use of the system or its components for unintended applications could result in injury to the operator, failure of the system, and could void the warranty.



CLEANING – If it should become necessary to clean this equipment, disconnect the unit from its power source first. Do not use liquid cleaners, aerosols, abrasive pads, scouring powders or solvents, such as benzene or alcohol. Use a soft cloth lightly moistened with a mild detergent solution. Ensure the surface cleaned is fully dry before reconnecting power.



Never modify or disassemble any component of the system. Modification or disassembly of the system could result in injury and void the warranty.



Always shut down the equipment and disconnect from all power sources prior to changing or servicing equipment. Failure to do so could result in injury or damage to the equipment.



Always use safety glasses when using electrical assembly tools.



Do not wear loose clothing, dangling jewelry, or loose unbraided long hair when operating this tool. A risk of entanglement is possible that may result in minor injury to the Operator.



Keep work area clear of clutter and distractions that may cause the operator to lose control of the tool or the components.



CAUTION – Do not use this tool if you are ill, on medication that is known to cause hand-eye coordination problems, under the influence of alcohol, illegal drugs or other impairing substances, or suffering from depression. This includes over-the-counter medications if they cause drowsiness, impaired judgment, or diminished physical skills. Consult with your management and advise them of your condition.



Do not operate this equipment without all guards and covers in place.



WATER AND MOISTURE – Do not place containers with liquids such as coffee, water, sodas, etc. on this unit. Do not operate this unit in a wet environment.



Electronics Disposal - Must be recycled as required by local environmental law – do not dispose of by adding to the Municipal waste stream.



Metal/Other Parts of the System - Must be recycled as required by local environmental law.

Introduction

Thank you for investing in the ASG-SD2500 Precision Screwdriver System from ASG Precision Fastening! This user's guide will assist you with setting up your system.

Please start by finding the serial number labels on each component of your system (similar to those below).

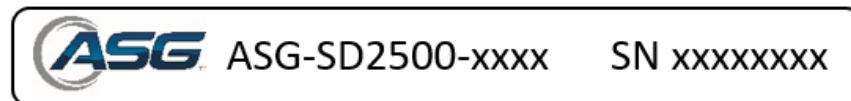
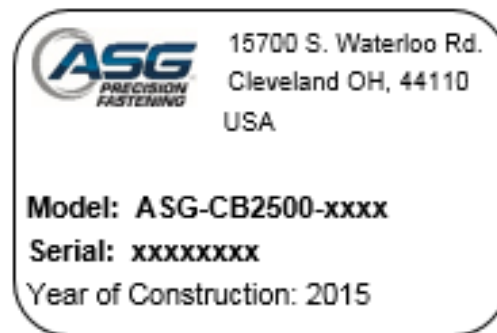

Take note of the serial numbers and record it below with your date of purchase. This information will be necessary should any service be required in the future.

ASG-CT2500 Serial Number: _____

ASG-CB2500-xxxx Serial Number: _____

ASG-SD2500-xxxx Serial Number: _____

Date of Purchase: _____

Tool Model Number Key

ASG-SD2500-20PL

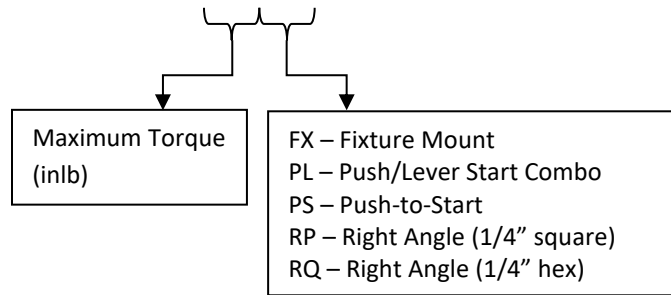

Cable Model Number Key

ASG-CB2500-10HW

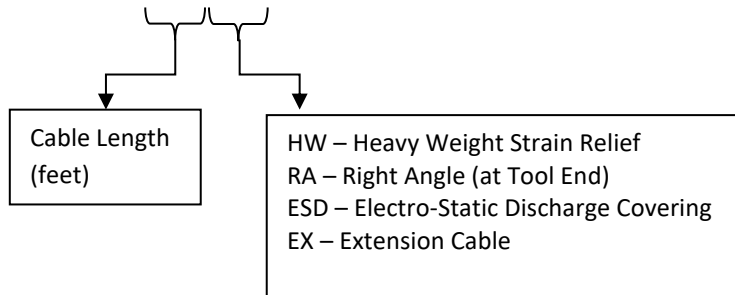

Installation

Controller Installation & Power Requirements:

The ASG-CT2500 comes standard with a mounting plate for attaching to the wall, workbench, or tool stand. Secure the controller using the (4) provided holes in the mounting plate. These provided holes are meant for #6 screws.

For other ASG-CT2500 mounting options, please visit the website at: <http://www.asg-jergens.com>

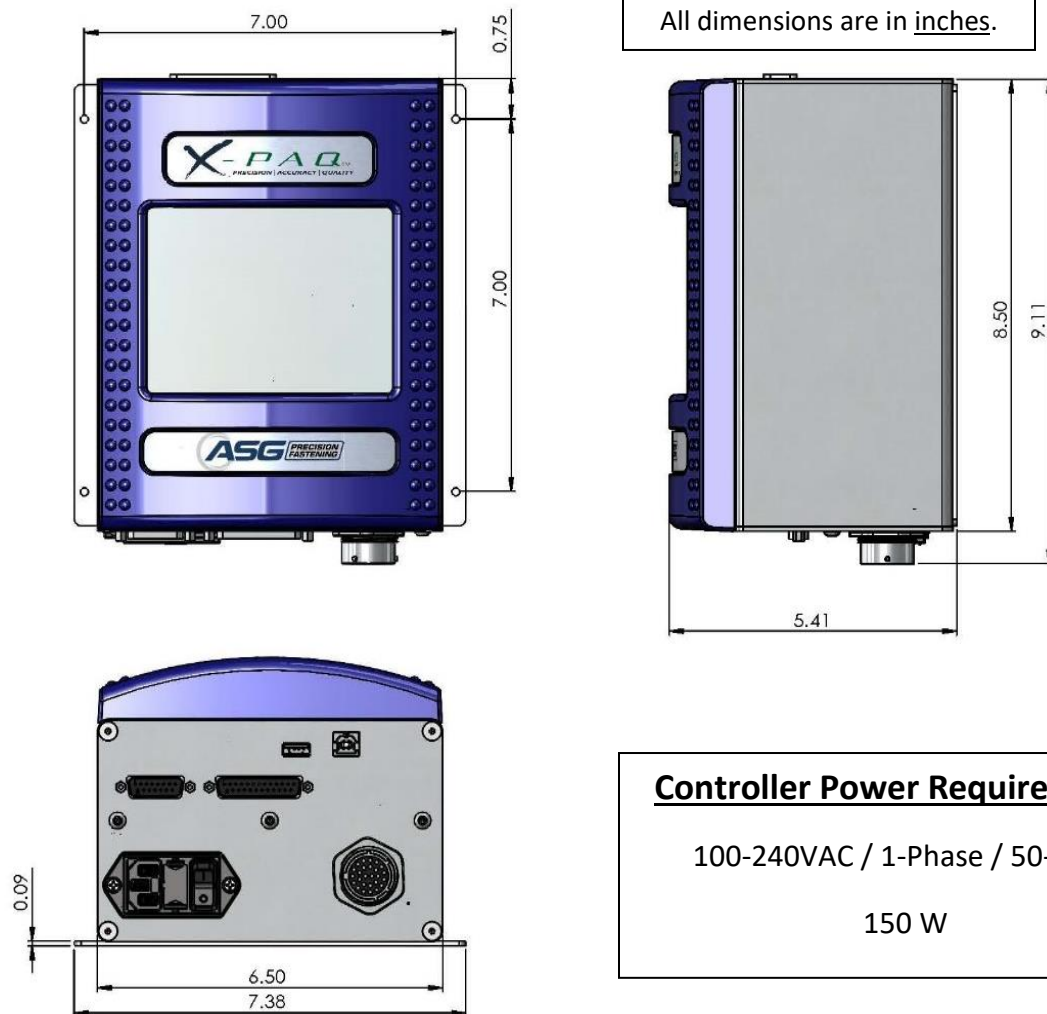

Controller Power Requirements:

100-240VAC / 1-Phase / 50-60Hz

150 W

Ensure the controller power cord can reach a properly grounded receptacle without creating a trip hazard in the work area. The controller should also be mounted within view of the operator, and should be accessible and within reach for programming and modification. Provide adequate clearance on all sides for access of technicians and 6" of clearance below for cables to attach to the ports.

Tool Installation:

Connect the tool cable to the connector on the bottom of the controller by identifying the alignment tabs in the large cable connector. Align these tabs and insert the cable to the controller, then rotate the twist-lock on the cable connector clockwise until it *clicks* into place.



Note: To remove the cable from the controller, rotate the twist-lock on the cable connector counter-clockwise until it pops free, and then remove the cable from the controller.

Obtain the ASG-SD2500 tool and identify the key slot on the screwdriver connector into which the screwdriver cable connects. Find the red dot on the small end of the cable, and align it to the slot in the screwdriver connector. Insert the cable to the tool firmly until it *clicks* into place.

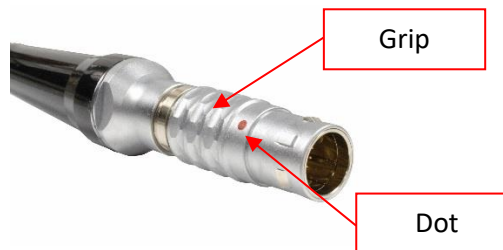

Note: To remove the cable from the tool, slide the grip of the cable connector away from the tool, then pull the cable out of the tool.

Connect the controller to the power source and power-up the controller.



Do not depress either the push to start spindle or the throttle lever during controller power-up, doing so may result in a ToolEE Error which will require a reboot of the controller.

Pistol Grip Assembly

Should the application require it, ASG Precision Fastening offers an optional Pistol Grip Assembly (P/N ASG-AC2500-PG) for sale.

To Install:

- Ensure the screwdriver cable is removed from the tool
- Use a 5/32" punch to drive out the throttle lever pin that attaches the throttle lever to the screwdriver
- Remove the throttle lever and spring from the tool (save these pieces to use at a later time to convert the tool back to the In-Line configuration)
- Slide the screwdriver into the pistol grip assembly with the forward/reverse buttons facing directly opposite the handle
- Position the heel of the pistol grip to the tool where the throttle lever was just removed and align the holes
- Re-insert the throttle lever pin to the tool through the pistol grip heel, carefully drive it into place so that the pin is below the surface of the tool
- Use a 5/32" Allen wrench to tighten the fastener by the trigger until it is secure

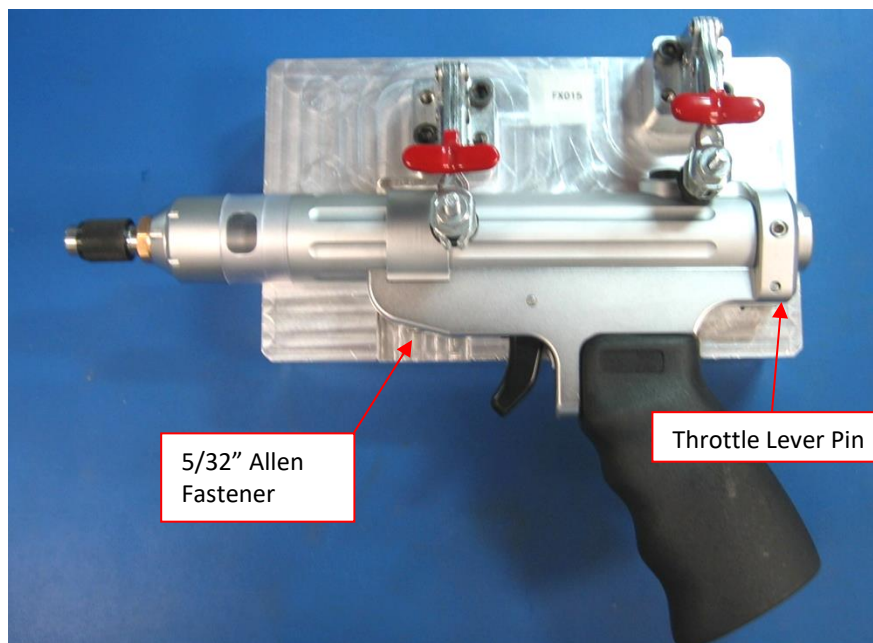

ASG-SD2500 Functions

All ASG-SD2500 Screwdrivers are of light-weight aluminum construction and come standard in the inline configuration, with optional pistol grip and lever triggers.

Standard Features:

- Forward/Reverse Button
- LED Status Ring – indicates torque/angle high, low, or pass
- High Intensity LED Headlights (not present on fixture mount or angle models)
- Push-to-Start triggering (inline models only)
- ¼" Hex Quick-Change Chuck (inline models only)
- Suspension Bail

Optional Features:

- Throttle Lever
- Fixture Mount Body

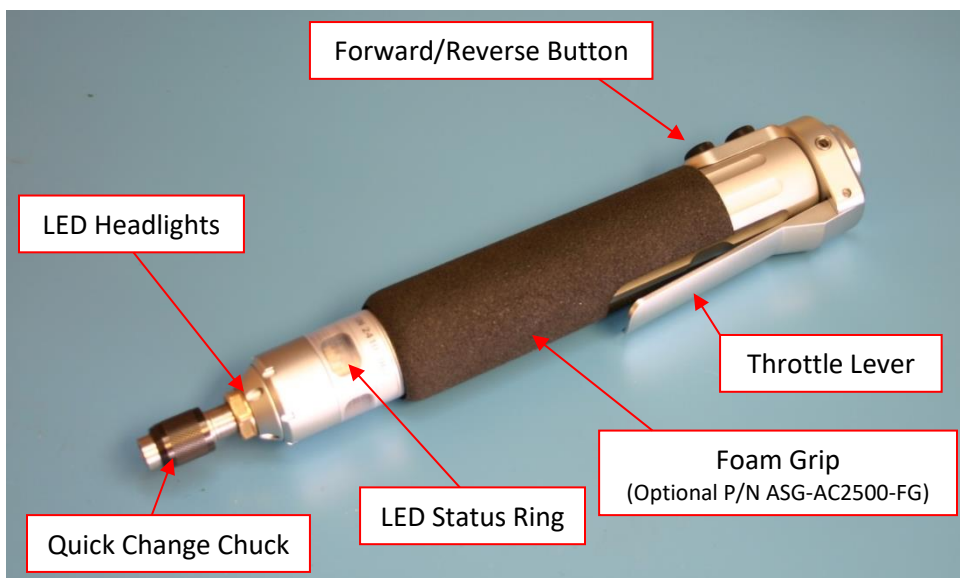

All ASG-SD2500 Series Screwdrivers have programmable internal memory that contains configuration information from the factory. It will identify itself to the controller and provide the following information:

- Tool Model Number
- Tool Serial Number
- Cycles Completed
- Maximum Torque
- Maximum Speed
- Gear Ratio
- Calibration Value

ASG-SD2500 Operation

First-time users should take some time to become familiar with the ASG-SD2500 prior to use. With the power to the controller off, cycle the lever and push-to-start spindle to become accustomed to the feel and resistance. Repeat this step with the controller power on, to feel the operation of the tool.

Motor Specifications

Motor Voltage:	32 VDC
Motor Power:	50 Watt

Forward/Reverse

Depress and release the forward/reverse button on the tool to switch between forward (RH rotation) and reverse (LH rotation). A straightforward way to know which mode the tool is in is that if the colored LED lights are flashing on/off, the tool is in reverse.

Changing Bits

Bits can be changed easily through the use of the Quick-Change Chuck that comes standard with the inline versions of the ASG-SD2500 Screwdriver. Inline drivers (PL, PS, & FX models) are intended to use ¼" hex power bits. Right angle models utilize either ¼" square sockets for the RP model, or ¼" insert bits for the RQ models. Power drive bits are not recommended for the RQ models.

To insert a bit: Align the bit's hex end into the spindle opening. Grasp the black collar on the quick change chuck and push it away from the tool towards the bit. Apply pressure to the bit until it *clicks* into place. Release the black collar and gently pull on the bit to ensure it is seated and locked into place.

Run Tool Screen

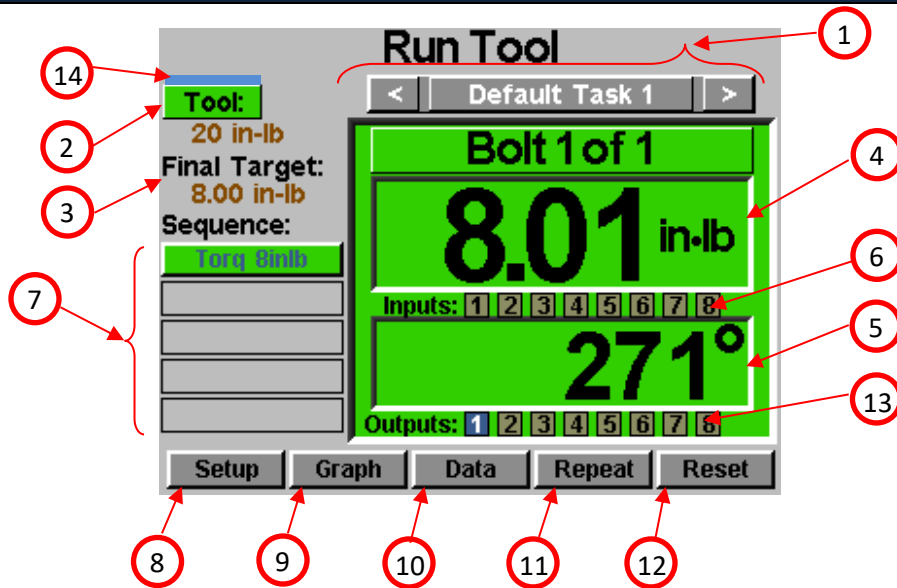

1. Task Selection: Shows the user the current task, and allows the user to select one of 99 available tasks. Selecting the button with the task name will bring up the Task Menu where another task may be selected or altered. The arrow keys will advance to the previous or next task. Settings for bolt counts, parameters, inputs, outputs, etc will switch with these actions to the settings of the selected task.
2. Tool Button: Displays the Tool Information screen that shows tool characteristics.
3. Final Target: Displays the target value of the active Parameter, either torque or angle.
4. Torque Reading: Displays the torque seen by the tool during or at the end of the fastening cycle. This field will color code at the end of a fastening cycle to denote Pass (green), Fail – High (red), or Fail – Low (yellow) as defined by high and low limits of the selected Parameter.
5. Angle Reading: Displays the angle seen by the tool during or at the end of the fastening cycle. This field will color code at the end of a fastening cycle to denote Pass (green), Fail – High (red), or Fail – Low (yellow) as defined by high and low limits of the selected Parameter. The field remains un-highlighted when Angle Monitoring is disabled within the Parameter.
6. Inputs: Displays (1) radio button for each of the (8) available inputs. The appropriate radio button will illuminate blue when the input is active.
7. Bolt Sequence Steps: Displays the sequence step and selected parameter. The parameter name will be highlighted red, yellow, or green at the end of its cycle to show its status. This sequence shown is for the current bolt only.
8. Setup Button: Takes you to screens where you may set up Tasks, Parameters, Bolt Sequences, Inputs, Outputs, and System Settings.
9. Graph Button: Displays the most recent fastening cycle graphically as Torque vs. Time, Angle vs. Time, Torque vs. Angle, Speed vs. Time, and Power vs. Time.

10. Data Button: Displays a table that contains rundown characteristics for the last 100 fastening cycles. Additional data is available in the internal memory and can also be downloaded to a USB flash drive from this screen.
11. Repeat Button: Depressing this button keeps the controller on the current bolt in a batch. The bolt sequence will not advance to the next bolt until the button is released.
12. Reset Button: Depressing this button resets the fastening bolt count in the event of a failure, retry lockout, or user request. The reset button also resets any currently active outputs. This button may be disabled when the controller is locked with a password.
13. Outputs: Displays (1) radio button for each of the (8) available outputs. The appropriate radio button will illuminate blue when the corresponding output relay is closed.
14. Saving Indicator: Appears briefly when data is being saved to X-PAQ™ internal memory.

Tool Information Screen

This screen displays characteristics of the tool that is currently attached to the ASG-CT2500 controller such as:

- Model Number
- Serial Number
- Number of Cycles on the Tool
- Max Torque
- Maximum Speed
- Gear Ratio
- Calibration Value
- Last Repair Date
- Cycles Since Last Repair
- Alarms Settings window



All the information shown on the screen above is stored on the internal memory of the SD250 screwdriver itself, and therefore travels with the tool when taken from one controller to another.



CAUTION: Tapping on the Calibration Value will take you to a screen where the value can be manually changed. This screen is for qualified calibration technicians only. Improperly changing the calibration value of the tool could lead to inaccurate torque readings and potential tool damage.

Alarm Settings:

The alarm settings window allows the user to program the controller to alert the user when either a certain number of months from last service or cycles since last service has been reached. Modification of alert levels in this window require the use of a USB key file which can be obtained from ASG by contacting ASG Customer Service at asginfo@asg-jergens.com or through the ASG Regional Sales team members.

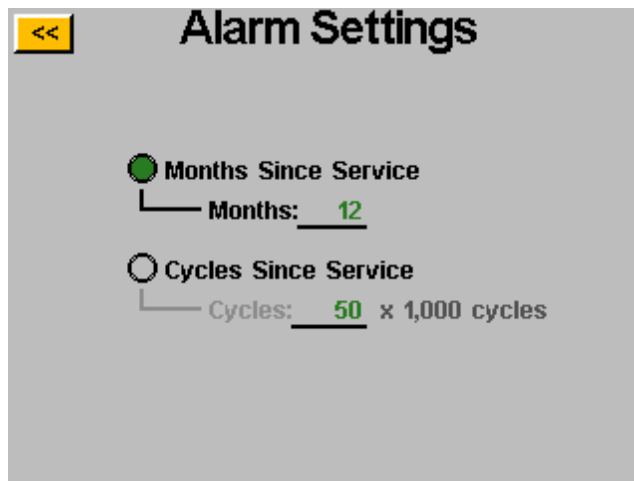

The months alert is based on the current date programmed into the controller vs. 'Last Repair Date' in the tool memory.

The cycles alert is based on the difference between 'Cycles' and 'Cycles Since Repair' fields on the tool memory.

When an alert threshold is passed, the 'Tool' button on the 'Run Tool' screen flashes between green and yellow and 'Service' is displayed on the main window. Entering the 'Tool Information' screen will also yield a pop-up window to draw attention to the service alarm having been passed.

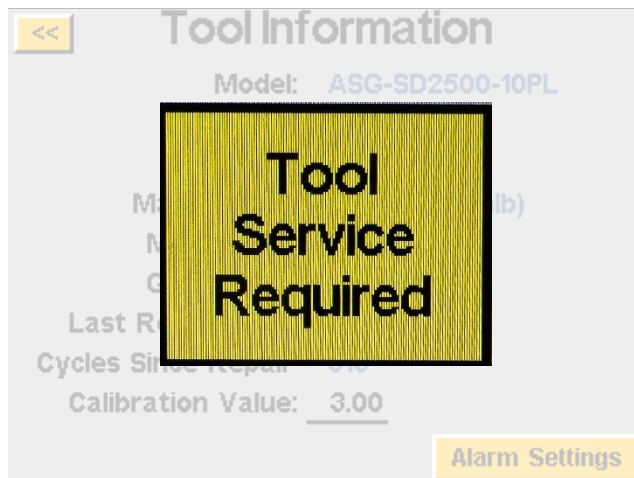
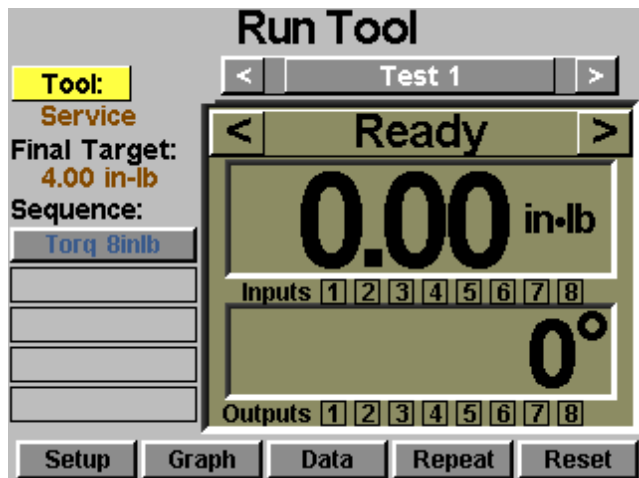

Tool Service Alarms will not disable the use of the tool, just prompt the user for service based on the programmed thresholds.



Note: 'Last Repair Date' and 'Cycles Since Repair' fields can only be changed by ASG authorized repair centers, a screwdriver will need to be serviced by one of those centers to update the fields.

Setup Screen

Entering the setup screen allows you to modify the settings of each task's parameters, bolt counts, bolt sequences, inputs, outputs, reverse settings, and triggering.

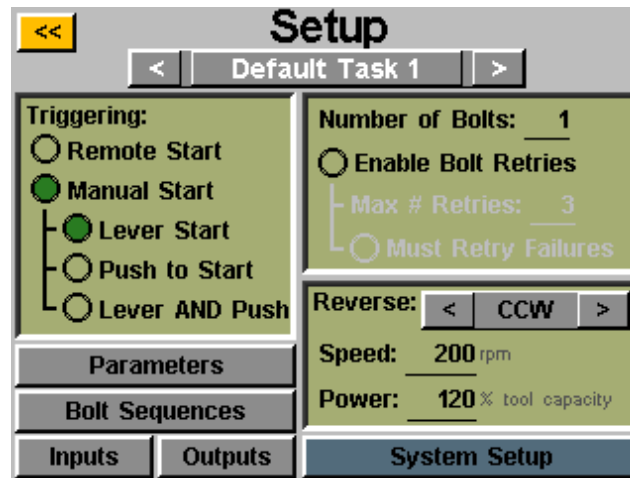

Tool Triggering:

On the 'Setup' screen, each task can be set up to trigger the tool in the way that best fits that task. The tool can be set up for remote start, lever start (if tool is equipped with a lever or pistol-grip attachment), push to start, lever or push to start (together), or lever and push to start. To select, just tap the radio button next to the desired option(s).

For remote start applications, the triggering will have to be configured in the 'Inputs' section of the Task Setup screen. See the Input programming section of this manual for more details.

Bolt Counts:

Setting up the bolt counts for each task can be done through the task setup screen. Under the 'Number of Bolts:' window, tap the underlined number to change the number of bolts to be secured on that task. This will build what some users call a batch. The controller will display the bolt count on the 'Run Tool' screen.

The controller will accept up to 300 bolts per task, but once the user-input bolt count rises above 300, the controller will automatically save the maximum value of 300 to the batch.

No matter how many bolts are in the batch, a torque or angle control parameter(s) must be assigned to a given bolt in order for it to run. See the Parameter Setup and Bolt Sequences sections of this manual for more information.

Bolt Retries:

To enable this feature, tap the radio button on the task setup screen under the number of bolts. Set the number of retries before lockout by tapping the number and inputting the desired value. **A retry is counted when the tool is put into reverse and triggered (run).** After the designated value of retries have been attempted, the tool will not perform another rundown without tapping the 'reset' button on the 'Run Tool' screen. If bolt retries are not enabled, the controller will advance the bolt count to the next one in sequence regardless of a pass or fail.

Must Retry Failures:

To enable this feature, tap the radio button on the task setup screen under the bolt retries. With this feature enabled, any failed rundown will require a retry and successful result before proceeding to the next rundown in sequence. **A retry is counted when the tool is put into reverse and triggered (run).** Once the previously failed rundown is successfully completed, the bolt count will advance with the next trigger of the tool. If the attempted numbers of retries are unsuccessful, the tool will be disabled until the reset button is pressed. See the password screen to enable operator lockout.

Reverse Settings:

In each task, the reverse settings must be defined. More specifically, when the reverse button on the tool is pressed and released (and the colored LED lights on the tool are flashing), the user must tell the controller how fast to turn, what direction, and at what percent of the tool's maximum torque. For instance, if a 50 inlb tool is connected to the controller, and the Reverse Power is set to 50%, the tool will be able to use 25 inlb of torque to remove a fastener before the tool stalls. These reverse settings can be different for each task in the controller if the user wishes, or they can all be set identically for uniformity.

Reverse can also be disabled by using the arrow button to cycle the direction through CW and CCW to Disabled. When disabled, the tool can be put in reverse mode by pressing and releasing the reverse button, but the tool will not run when triggered, a message will appear on the screen indicating that reverse is currently disabled.



CAUTION: Be sure to test and verify the reverse settings function as desired for a given application to avoid any injury or damage to parts or equipment.

Parameter Setup:

From the task setup screen, select the Parameters button. Shown will be a button for each of the 24 available parameters for that task.

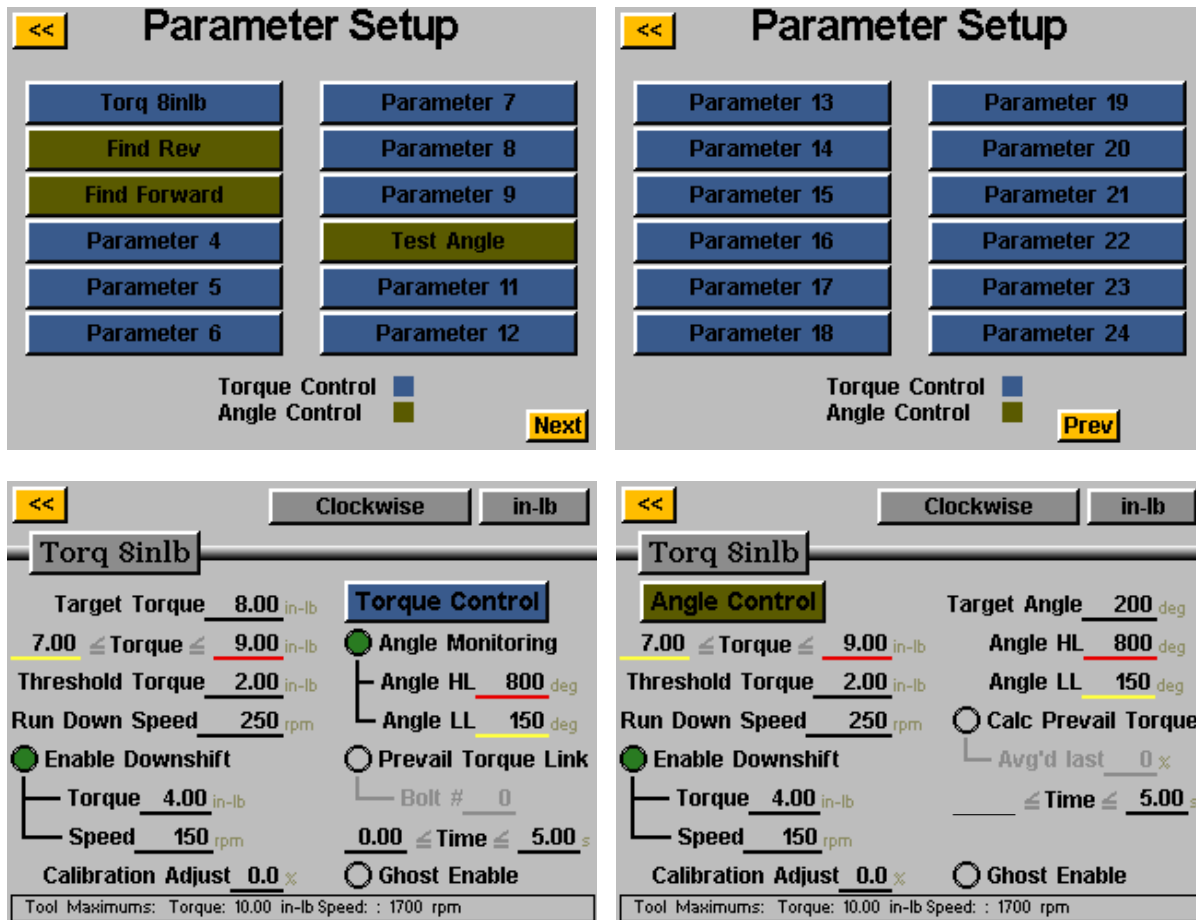

Some useful definitions for the Parameter Setup:

- Target Torque:** The torque value at which the tool should stop the fastener rundown (Torque Control parameters only). Target torque must be set between HL and LL values.
- Target Angle:** The angle value at which the tool should stop the fastener rundown (Angle Control parameters only). Target angle must be set between HL and LL values.
- Torque HL/LL:** The High Limit (HL) or Low Limit (LL) of acceptable torque for the fastener in the user's process. Parameters will stop if the HL value is reached during a cycle.
- Angle HL/LL:** The High Limit (HL) or Low Limit (LL) of acceptable angle for the fastener. In Torque Control Profiles, this monitoring may be disabled by tapping the 'Angle Monitoring' radio button.
- Calc. Prevail. Torque:** Enabling this feature sets the final % of a rundown during which the prevailing torque is calculated. (Angle Control parameters only) See Prevailing Torque section of this manual for more detailed information.

Threshold Torque:	The torque reading at which the tool enters the fastening cycle. Once the tool reaches the threshold torque, it will begin to count the angle of revolution until either the final torque or final angle (depending on Torque or Angle Parameter).
Run Down Speed:	The speed (rpm) that the tool will run (RH or LH rotation) from the time the tool is triggered until either the final target is met, or the downshift point is met (if enabled).
Downshift Torque:	The torque at which the tool will shift from the run down speed to the downshift speed.
Downshift Speed:	An optional second speed that the tool may slow down to at a defined torque limit. This can be disabled by tapping the 'Enable Downshift' radio button.
Time:	The minimum and maximum allowable time (in seconds) between when the tool is triggered and the end of the process. The screwdriver will shut off on its own if the fastening cycle is not completed by the maximum time and deliver a 'Parameter Time > MAX' message.
Prevail Torque Link:	Allows you to link to a previous bolt's prevailing torque calculation for compensation of the same bolt later in a sequence. See Prevailing Torque Link section for more information.
Calibration Adjust:	Individual correction factor programmable by the user (range $\pm 5.0\%$) that will adjust the driver torque output to allow for correction on a parameter level to align to torque master. <u>This value is stored in the X-PAQ™ controller, not in the SD2500 screwdriver memory.</u> This function requires the use of a USB key file which can be obtained from ASG by contacting ASG Customer Service at asginfo@asg-jergens.com or through the ASG Regional Sales team members.
Ghost Enable:	Enabling this feature allows the user to perform the functions of the selected parameter in a bolt sequence without reporting the result as final data to the data tables or ASG-NW2500 networking module. This is most often used when the last step of a bolt sequence is something the user wishes to perform but not retain the data as the final result.

To set up a parameter:

- 1) Select one of the Parameter buttons on the Parameter Setup window and select either Torque Control Profile or Angle Control Profile by tapping the button on the right side of the screen to toggle between the choices. Whichever option is enabled will show in a colored box on the parameter window.



Note: Torque Control Profiles Parameters will appear in BLUE on the parameter list and Angle Control Profile Parameters will appear in GREEN.

- 2) Select the direction of rotation for the parameter by toggling between 'clockwise' and 'counterclockwise' at the top of the screen.
- 3) Select the torque units by selecting the button at the top right hand corner of the screen, then selecting the units required.
- 4) Name the parameter by selecting the button below the yellow [<<] button and using the on-screen keypad to enter the desired name.
- 5) Fill out the rundown characteristics by tapping on the underlined areas and using the on-screen keypad to enter the information.
- 6) Tap the yellow [<<] button to return to the parameter list and select 'Yes' to save the changes.

Bolt Sequences

The 'Bolt Sequences' button allows the user to select which parameter(s) will run for a given bolt inside each task. To assign a parameter to a bolt, select the bolt number (or multiple bolts if they will all have the same parameter(s)) then tap the button to the right to access the parameter list. Tap the parameter name you wish to choose to select that parameter for that bolt.

The 'Number of Bolts' is assigned in the 'Setup' screen on each task, reference the 'Setup Screen' section of this manual for more information.

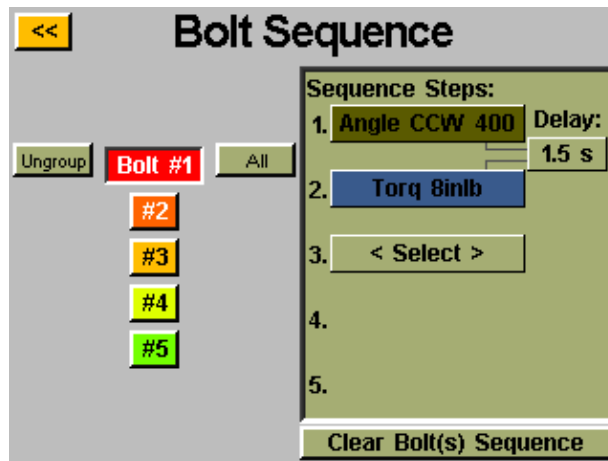

Multiple bolts can be grouped together and all assigned parameters simultaneously, and they would need to be selected and ungrouped to program separately again. Select multiple bolts then the 'Group' button to group them together, or 'Ungroup' to remove the group.

Each bolt can have up to 5 parameters assigned to run in sequence as well. A time delay between parameters may be programmed in this screen should the application require it. Each bolt can be selected separately, or in groups to assign any of the 24 available parameters on that task.

When using multiple parameters on a single bolt, only one trigger pull is required for the bolt, but the trigger must be held until the entire sequence is completed. Releasing the trigger in the middle of the sequence will result in a 'sequence aborted' error.

Should one step of a sequence fail during a rundown, the bolt sequence will fail at that point and not proceed to the next step of the sequence.

Prevailing Torque

Certain applications (such as self-tapping fasteners or fasteners into locking helical inserts) require compensation for the prevailing torque of a fastener in the final torque of the rundown. This can be accomplished using the 'Calc Prevail Torque' feature in an angle control parameter. For easy identification, angle control parameters using the prevailing torque option have a purple outline on the parameter blocks.

The desired compensation can be accomplished by programming a 2-step rundown, starting with an angle control parameter (with the prevailing torque calculation enabled), followed by a torque control parameter.

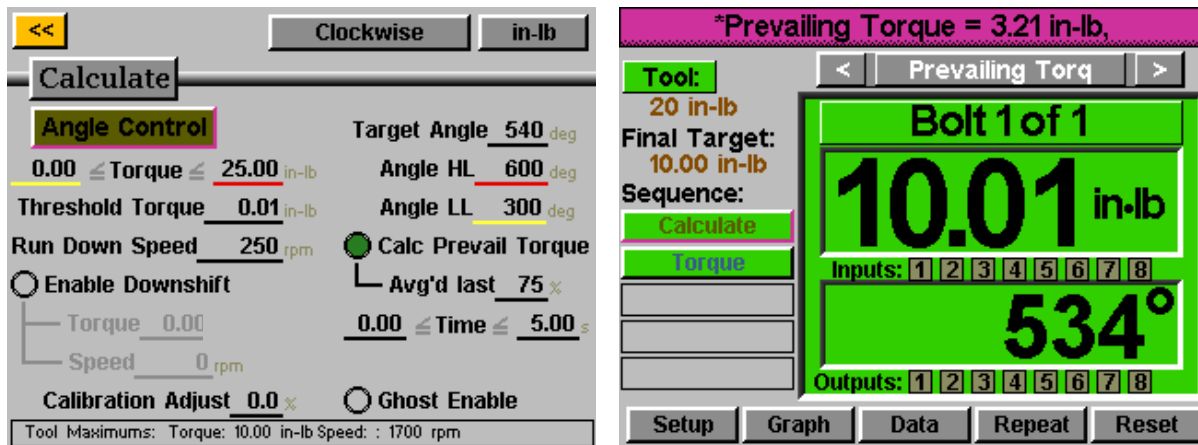

In the example shown above, the fastener is rotated 540 degrees in step 1, during the last 405 degrees (75%) the prevailing torque is monitored and the average value reported. Step 2 is then performed to a target of 10 inlb, but the actual applied torque is the final torque of 10.01 inlb plus the 3.21 inlb calculated for a total of 13.22 inlb.

The torque displayed on the 'Run Tool' screen will be just the clamping torque as targeted in the torque control parameter programmed to the final step. To see a breakdown of the prevailing torque and the total applied torque, view the rundown data on the 'Data' screen of the controller.

Utilizing this method will calculate the prevailing torque for each fastener eliminating the need to determine an average value for all fasteners and then using a standard torque profile only with a larger target.

Prevailing Torque Link

Certain specialized applications may require the calculation of prevailing torque, while also having the ability to recall and compensate for that prevailing torque later in the batch.

Example: 2 bolts to be secured with prevailing torque compensation to a snug torque of 3 inlb, then each bolt is re-torqued to 8 inlb with prevailing torque compensation (from the original snug torque operation).

In the Task Setup screen, the number of bolts would be set to 4.

Set up (1) Angle Control parameter suitable to calculate the prevailing torque, and (1) Torque Control parameter for the snug torque of 3 inlb. Sequence these parameters together for bolts 1 & 2 in the 'Bolt Sequences' screen.

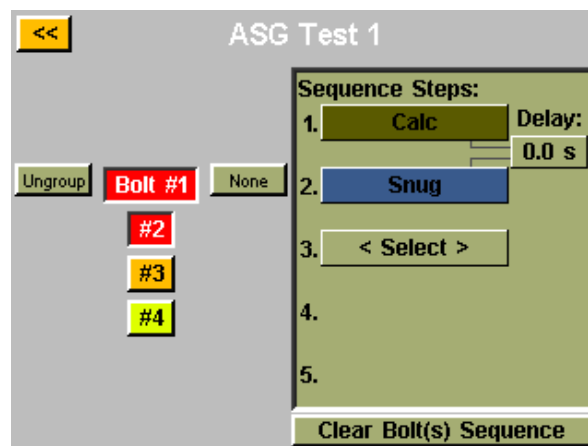
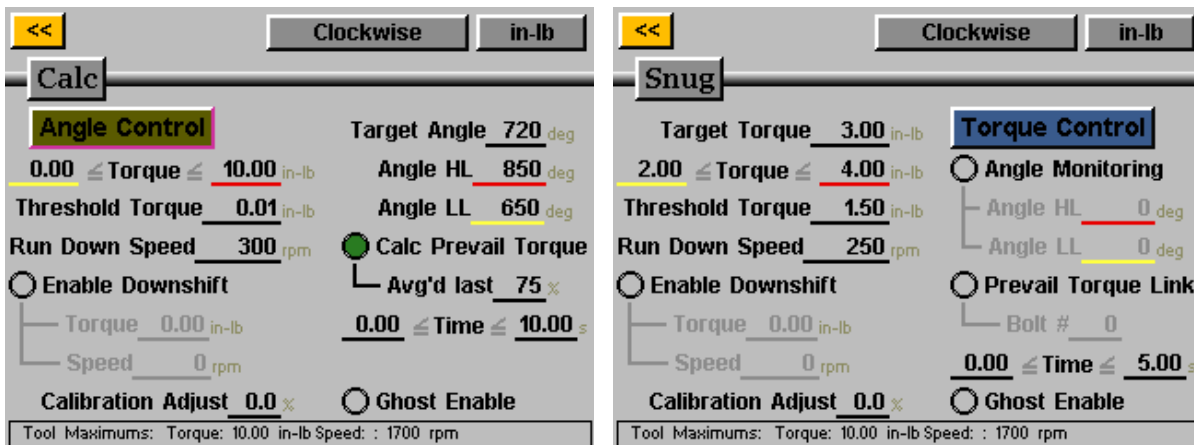

Set up (2) nearly identical Torque Control parameters for the final torque of 8 inlb *except* that the Prevail Torque Link will be different. The parameter assigned to bolt #3 will have the Prevail Torque Link set to 1. The parameter assigned to bolt #4 will have the Prevail Torque Link set to 2. Set the Bolt Sequences screen accordingly for bolts 3 & 4.

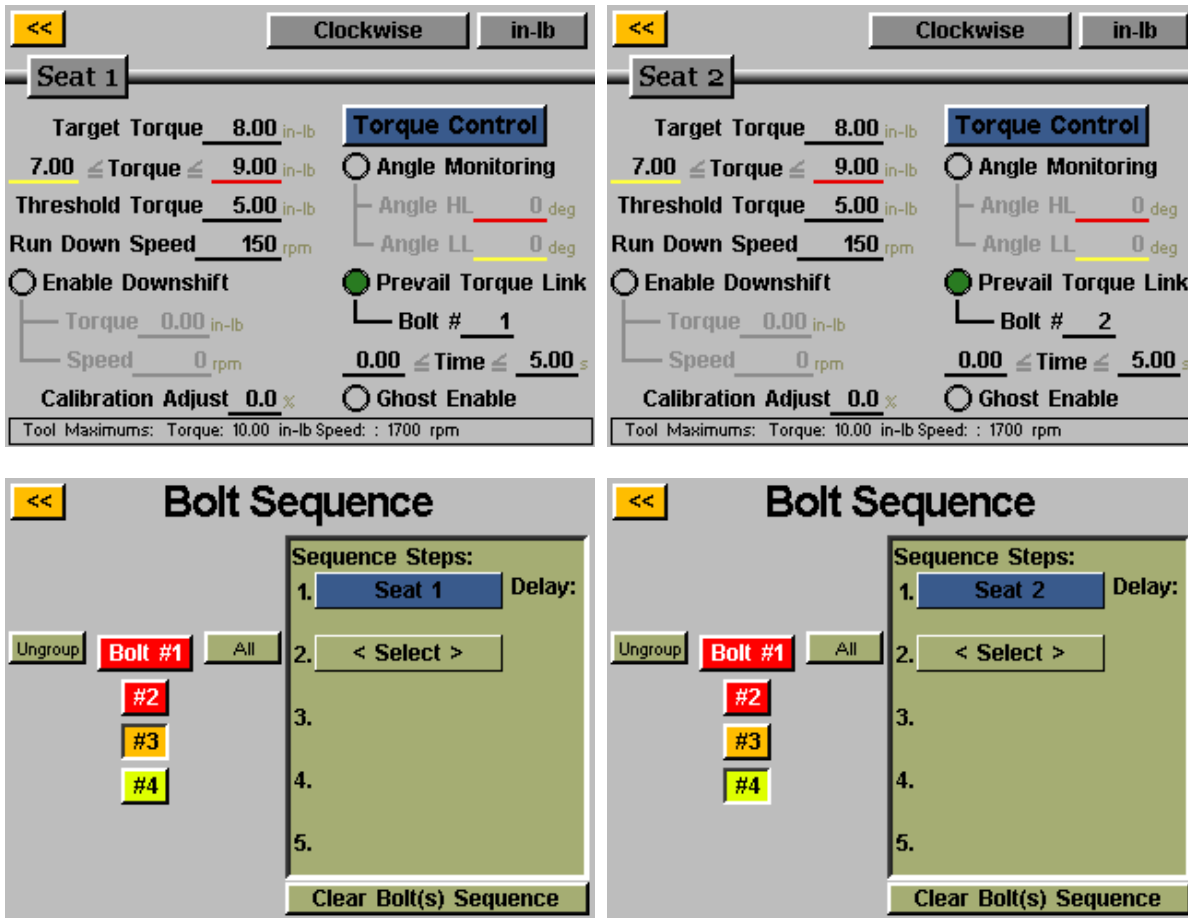

The controller will perform the prevailing torque calculation for the 2 fasteners during the initial snug phase, then the final torque will pull the original prevailing torque from memory, and also use it to compensate when performing the final torque.

Task Setup

From either the 'Run Tool' or 'Setup' screens, tapping the task name will bring up the 'Task Setup' screen shown below:

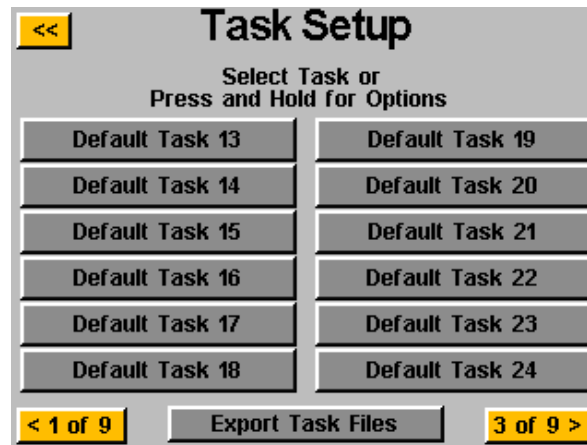

All 99 tasks are displayed here and tapping any one will switch to that task.

Renaming and Importing Tasks

From the 'Task Setup' menu, pressing and holding on a task name will display the following screen:

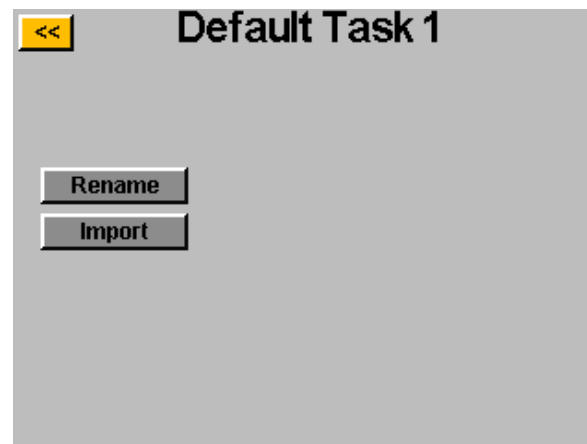

Tapping the 'Rename' button will allow the user to enter a customized name with the on-screen keypad.

When a USB drive is inserted, the 'Import' button will be active, allowing the user to select a task file to import from the USB drive. **The task settings from the imported file will completely over-write the task shown at the top of this screen, there is no partial import.**

Exporting Task Settings to USB

The ASG-CT2500 controller is capable of exporting the task settings to USB for backup and transfer to other ASG-CT2500 controllers. To accomplish this, insert a USB flash drive with available memory to the port on the controller.

From the 'Run Tool' screen, tap the task name at the top to bring up the 'Task Setup' menu

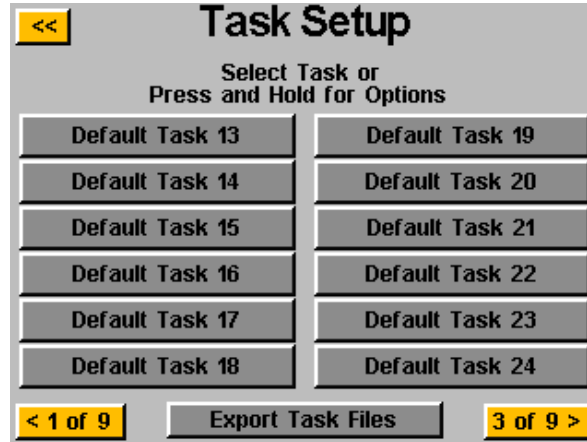

When a USB drive is inserted, the 'Export Task Files' button is displayed. Tapping this button will automatically save the setting files for all 99 tasks in the controller to the USB. The settings will be saved in the directory: \[Controller Name]\Config Where [Controller Name] is the user defined name programmed into the 'Name' box in the 'Controller Info' screen (see Controller Info section of this manual for more information). This is the same directory you must navigate to when importing a task file as well.



Note: Do not attempt to rename the individual task files on the USB flash drive. Doing so may corrupt the contained data and make it impossible to re-import to the controller. It is recommended that if a user needs to catalog saved task files, the individual files be placed into folders that can be named by the user.

Input Programming

There are (8) inputs, as well as a 24V DC and 0V DC supply available through the input connector on the bottom of the controller. On the 'Run Tool' screen, there is a row of lights at the bottom showing each of the 8 inputs. When an input is active, the light will illuminate blue to aid in trouble-shooting and setup. See the chart at the end of this section for pin location and other technical information. The instructions below detail how to set up various commands through the inputs.

- **TASK SELECT:** From the 'Run Tool' Screen:
 - Tap the 'Setup' Button
 - Make sure the task shown at the top is the one to be programmed.
 - Tap the 'Inputs' Button

Tap the button on the left that shows the task name. You should now see a column of buttons appear in the chart next to each input number. You may now select which input you want to use to select the task by tapping the 'Ignore' button to the right of that input. This will toggle between 'H', 'L', and 'Ignore' with each tap. The picture to the right of this button shows what the controller is currently seeing on that input. Press the yellow [<<] button at the top and save changes if desired.

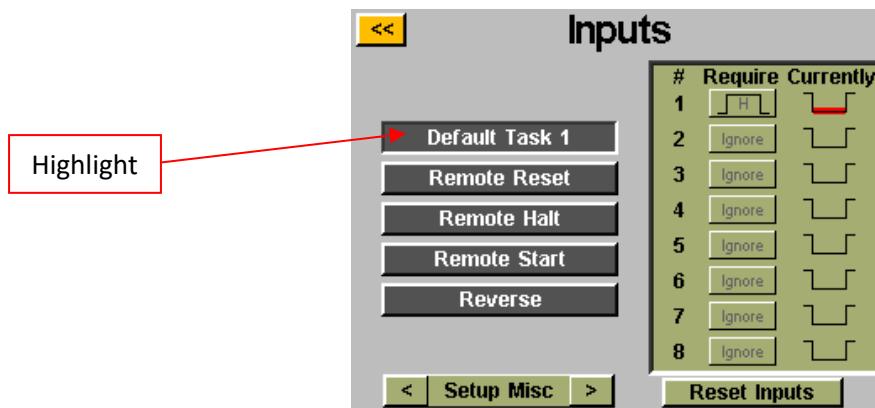

Note: after programming, the controller will switch to the task when that input is keyed, and will stay there until commanded to switch tasks either via the input or the touch screen controls. The input does not need to stay on for the task to remain enabled. If you desire the input to be active in order for the task to run, we recommend you go to the next section and setup each bolt in that task to require the same input used for the task selection.

If a task is being selected through the inputs by an external signal, the task button at the top of the 'Run Tool' or 'Setup' screens will be highlighted in blue and will not show the arrow buttons. In order to manually change the selected task, the external input will have to be removed to free the logic and allow the manual selection.

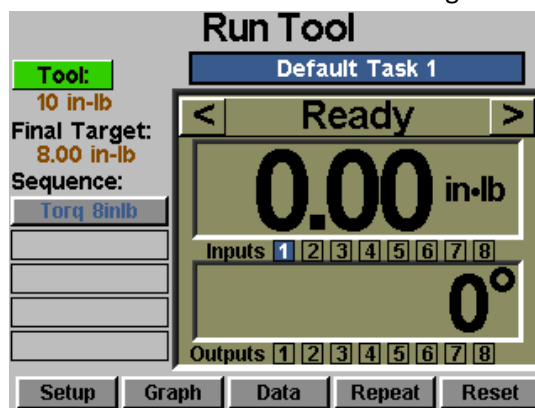

- **ENABLE BOLTS:** From the 'Run Tool' Screen:
 - Tap the 'Setup' Button
 - Make sure the task shown at the top is the one to be programmed.
 - Tap the 'Inputs' Button
 - Tap the arrow button on the bottom next to 'Setup Misc' so that 'Setup Bolt(s)' appears.

Assuming that there is only 1 bolt in your sequence, tap the button on the left that says 'Bolt 1'. You should now see a column of buttons appear in the chart next to each input number. You may now select which input you want to use to enable the bolt by tapping the 'Ignore' button to the right of that input. This will toggle between 'H', 'L', and 'Ignore' with each tap. The picture to the right of this button shows what the controller is currently seeing on that input. Press the yellow << button at the top and save changes if desired.

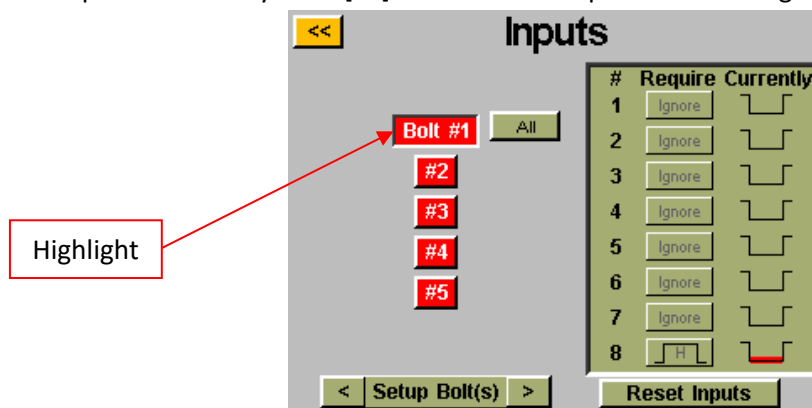

Note: If you have multiple bolts in your application sequence, it is recommended that you set that up in the 'Setup' and 'Bolt Sequences' screens prior to completing this step. You will then want to make sure you set up each bolt you wish to be enabled with the input. For your convenience, with multiple bolts an 'All' button will appear on the 'Input' screen to allow you to select all bolts and set them up simultaneously.

If the input requirements are not met (signal from an external device is not present or lost) for a given bolt when the user tries to trigger the tool, the tool will not run and a banner message will appear on the 'Run Tool' screen to notify the user that the input requirements are not met.

- **REMOTE START:** From the 'Run Tool' Screen:
 - Tap the 'Setup' Button
 - Make sure the task shown at the top is the one to be programmed.
 - Select the 'Remote Start' radio button in the 'Triggering' section.
 - Tap the 'Inputs' Button

Select the 'Remote Start' button on the left side of the screen. You should now see a column of buttons appear in the chart next to each input number. You may now select which input you want to use to start the tool by tapping the 'Ignore' button to the right of that input. This will toggle between 'H','L', and 'Ignore' with each tap. The picture to the right of this button shows what the controller is currently seeing on that input. Press the yellow [<<] button at the top and save changes if desired.

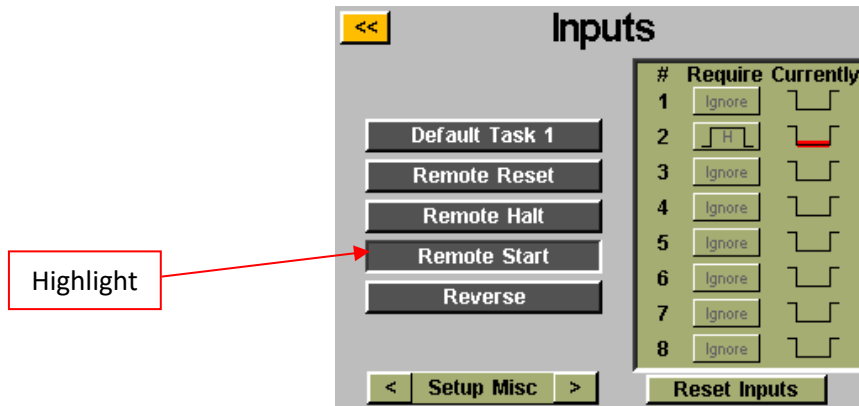

Note: The driver will require the start signal to be active the entire time the driver is meant to run. If the start signal is removed in the middle of a rundown, the driver will stop and give a 'sequence aborted' error on the 'Run Tool' screen.



Note: It is recommended that the remote start command not be given simultaneously to other commands such as a task select, a signal delay of 100ms or greater is recommended for optimal system performance.



Note: Remote start input programming button is only available when the task's triggering is set to 'Remote Start'.

- **REVERSE ROTATION SELECT:** From the 'Run Tool' Screen:
 - Tap the 'Setup' Button
 - Make sure the task shown at the top is the one to be programmed.
 - Select the 'Remote Start' radio button in the 'Triggering' section.
 - Tap the 'Inputs' Button

Select the 'Reverse' button on the left side of the screen. You should now see a column of buttons appear in the chart next to each input number. You may now select which input you want to use to define left hand rotation in the tool by tapping the 'Ignore' button to the right of that input. This will toggle between 'H', 'L', and 'Ignore' with each tap. The picture to the right of this button shows what the controller is currently seeing on that input. Press the yellow [<<] button at the top and save changes if desired.



Note: Ensure the reverse settings on the Task's 'Setup' screen are set to the desired settings (rotation direction, speed, and power). **In order for the reverse to function, the input selecting the reverse function must be active as well as the input for the remote start function. Only activating the reverse input will merely set the tool to reverse, it will still require the start signal to run.**

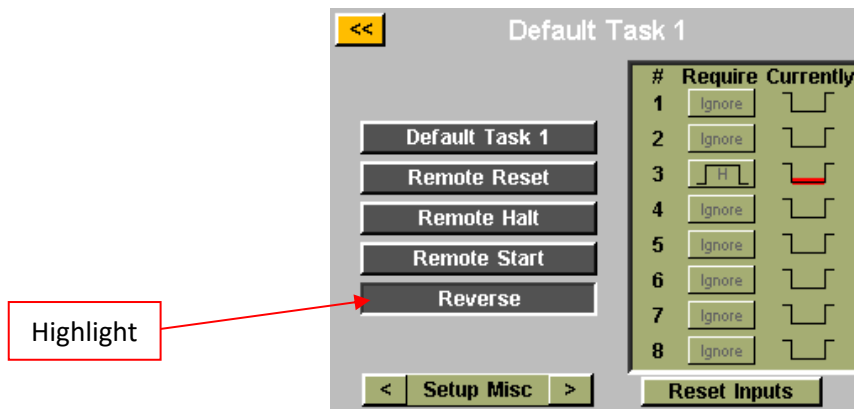

Note: Reverse input programming button is only available when the task's triggering is set to 'Remote Start'.

- **REMOTE RESET:** From the 'Run Tool' Screen:
 - Tap the 'Setup' Button
 - Make sure the task shown at the top is the one to be programmed.
 - Tap the 'Inputs' Button

Select the 'Remote Reset' button on the left side of the screen. You should now see a column of buttons appear in the chart next to each input number. You may now select which input you want to use to reset the tool by tapping the 'Ignore' button to the right of that input. This will toggle between 'H','L', and 'Ignore' with each tap. The picture to the right of this button shows what the controller is currently seeing on that input. Press the yellow [<<] button at the top and save changes if desired.

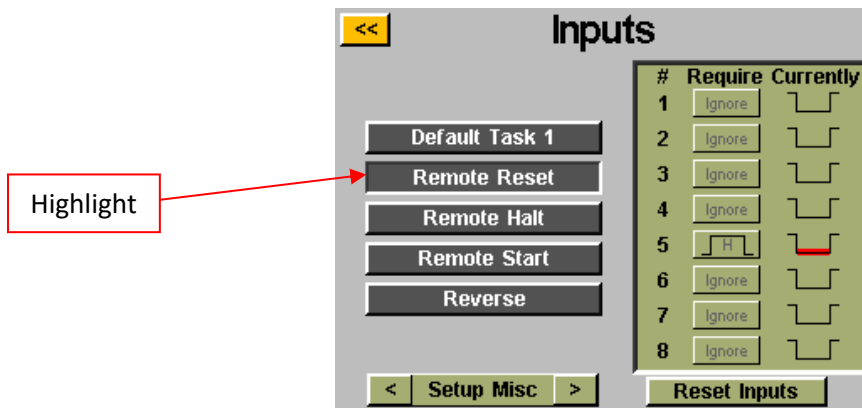

- **REMOTE HALT:** From the 'Run Tool' Screen:
 - Tap the 'Setup' Button
 - Make sure the task shown at the top is the one to be programmed.
 - Tap the 'Inputs' Button

Select the 'Remote Halt' button on the left side of the screen. You should now see a column of buttons appear in the chart next to each input number. You may now select which input you want to use to halt the tool by tapping the 'Ignore' button to the right of that input. This will toggle between 'H', 'L', and 'Ignore' with each tap. The picture to the right of this button shows what the controller is currently seeing on that input. Press the yellow [<<] button at the top and save changes if desired.

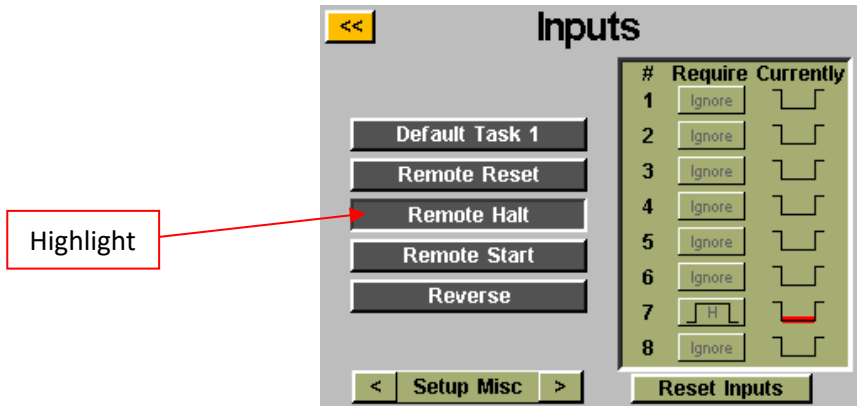

Note: If the remote halt is used during a rundown to halt operations, when the halt signal is removed, the tool trigger must be released before the tool will start again. This is true for manual and remote triggering.

Output Programming

There are (8) programmable outputs, 24V DC, and 0V DC supply available through the output connector on the bottom of the controller. See the chart at the end of this section for pin location and other technical information. All the outputs can be set up with the following instructions from the 'Run Tool' Screen:

- Tap the 'Setup' Button
 - Make sure the task shown at the top is the one to be programmed.
- Tap the 'Outputs' Button

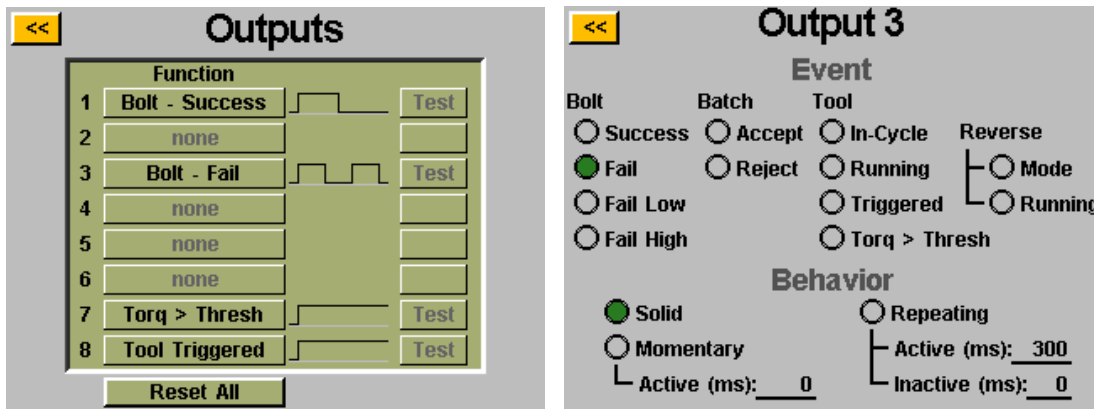

Select an available output button by tapping the 'none' button. Under the 'Event' heading, select the appropriate radio button. Select the type of output you would like under the 'Behavior' heading, and if necessary input the time intervals for the non-solid outputs. To adjust these values, tap on the number, enter the value you wish on the on-screen keypad, then tap the enter button. Any un-saved changes will appear in red until they are saved by exiting the screen with the yellow [<<] button.



Note: Back on the 'Outputs' screen, you will have the opportunity to test the output signal to your device by tapping the 'Test' button next to each output.

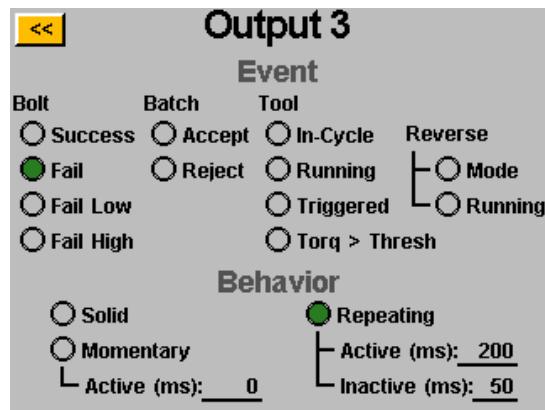

AVAILABLE OUTPUT CRITERIA:

- **BOLT - SUCCESS:** All torque and angle requirements fall within the predefined acceptable HL and LL ranges of the programmed parameter
- **BOLT – FAIL LOW:** Any torque and/or angle requirement fell below the predefined acceptable LL ranges of the programmed parameter
- **BOLT – FAIL HIGH:** Any torque or angle requirement fell above the predefined acceptable HL ranges of the programmed parameter
- **BATCH ACCEPT:** All bolts or cycles required in the task are complete and within the acceptable ranges
- **BATCH REJECT:** Some portion of the task did not complete within acceptable parameters
- **TOOL TRIGGERED:** All triggering criteria as defined in the setup screen have been satisfied. This output is only available as a solid output, not momentary or repeating. This output does not reset after a cycle is complete until the trigger is released.
- **TORQUE > THRESH:** The current torque reading from the tool is greater than the programmed threshold torque in the parameter being run. This output is only available as a solid output, not momentary or repeating
- **TOOL RUNNING:** Tool motor is running. This output is only available as a solid output, not momentary or repeating.
- **TOOL IN-CYCLE:** Tool is currently running and involved in a bolt sequence. This output will stay on in-between steps of a multi-parameter bolt sequence. This output is only available as a solid output, not momentary or repeating.
- **REVERSE MODE:** Tool is switched into reverse mode (either by tool button or device inputs). This output is only available as a solid output, not momentary or repeating.
- **REVERSE RUNNING:** Tool is currently in reverse mode and motor is turning. This output is only available as a solid output, not momentary or repeating.



Note: Ensure compatibility of the output receiving device with the user's programmed signal duration. Signal pulses less than 50ms could possibly be interpreted as noise by the receiving device.

Input/Output Port Pin Guide

Input Port (DB15 Male)

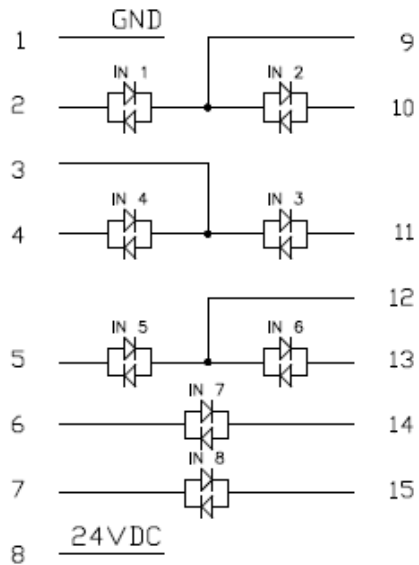
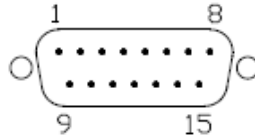

PIN	Function
1	0 VDC (from internal power supply)
2	Input 1
3	Common Inputs 3 & 4
4	Input 4
5	Input 5
6	Input 7 *
7	Input 8 *
8	24 VDC (from internal power supply)
9	Common Inputs 1 & 2
10	Input 2
11	Input 3
12	Common Inputs 5 & 6
13	Input 6
14	Input 7 *
15	Input 8 *

* Inputs 7 & 8 can use either pin as Common



Notes: All inputs are opto-isolated



Listed 24V DC pins are supply pins, do not hook up external 24V DC to the controller, internal damage can occur. Listed 0V DC pins are tied to the earth ground of the controller's power supply, do not hook up to external equipment grounds to avoid ground conflicts.

Output Port (DB25 Male)

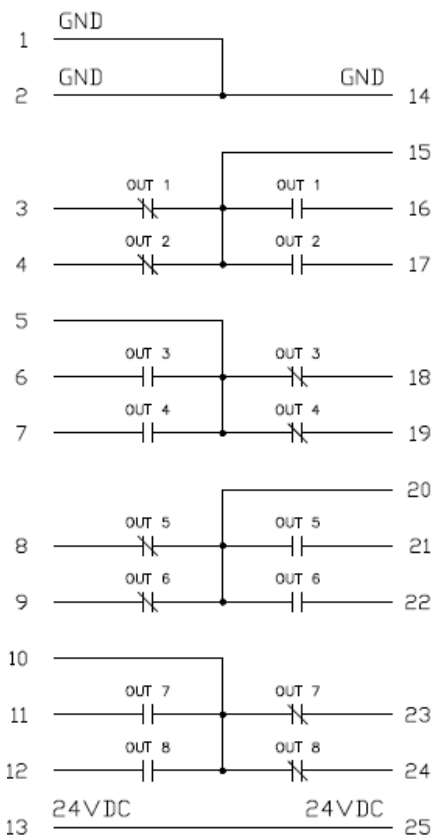
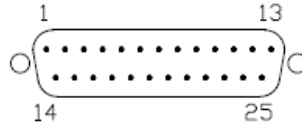

PIN	Function
1	0 VDC (from internal power supply)
2	0 VDC (from internal power supply)
3	Output 1 – Normally Closed
4	Output 2 – Normally Closed
5	Common – Outputs 3 & 4
6	Output 3 – Normally Open
7	Output 4 – Normally Open
8	Output 5 – Normally Closed
9	Output 6 – Normally Closed
10	Common – Outputs 7 & 8
11	Output 7 – Normally Open
12	Output 8 – Normally Open
13	24 VDC (from internal power supply)
14	0 VDC (from internal power supply)
15	Common – Outputs 1 & 2
16	Output 1 – Normally Open
17	Output 2 – Normally Open
18	Output 3 – Normally Closed
19	Output 4 – Normally Closed
20	Common – Outputs 5 & 6
21	Output 5 – Normally Open
22	Output 6 – Normally Open
23	Output 7 – Normally Closed
24	Output 8 – Normally Closed
25	24 VDC (from internal power supply)



Notes: Outputs are solid-state dry contacts relays.



Do not use CT2500 outputs to switch high inductive loads – damage to relays can occur.

Graph Screens

In order to assist the user with setting up and trouble-shooting problem joints, the latest rundown is stored in the controller in graph form. From the 'Run Tool' screen, tap the 'Graph' button at the bottom of the screen. Along the bottom of the screen can be found the available graphs, tap the appropriate button to view:

- **Torque vs. Time:** Graphs the last rundown with Torque on the Y axis in whatever units are specified in the parameter, and Time on the X axis in milliseconds (ms).

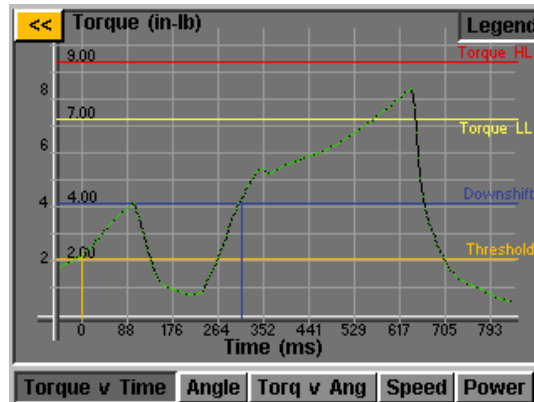

- **Angle vs. Time:** Graphs the last rundown with Angle on the Y axis in degrees (deg), and Time on the X axis in milliseconds (ms).



- **Torque vs. Angle:** Graphs the last rundown with Torque on the Y axis in whatever units are specified in the parameter, and Angle on the X axis in degrees (deg).

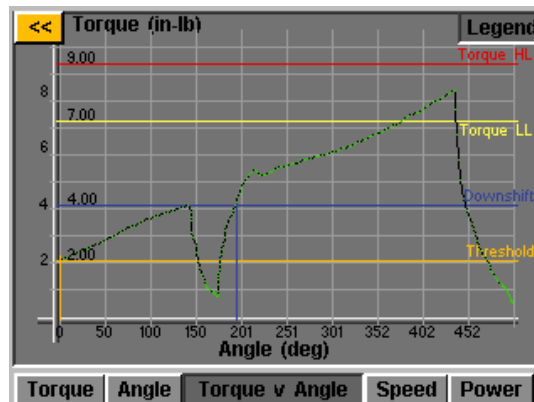

- Speed vs. Time: Graphs the last rundown with Speed on the Y axis in rotations per minute (rpm), and Time on the X axis in milliseconds (ms).

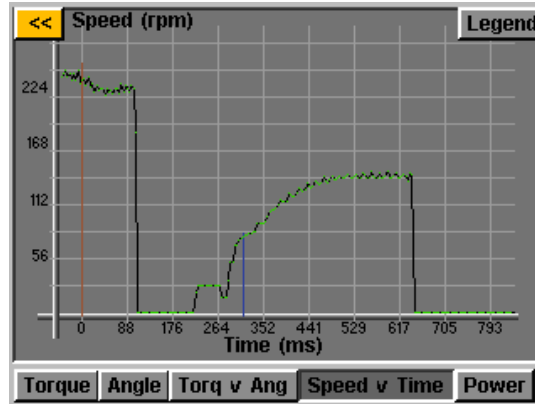

- Power vs. Time: Graphs the last rundown with Power on the Y axis in Watts (W), and Time on the X axis in milliseconds (ms).

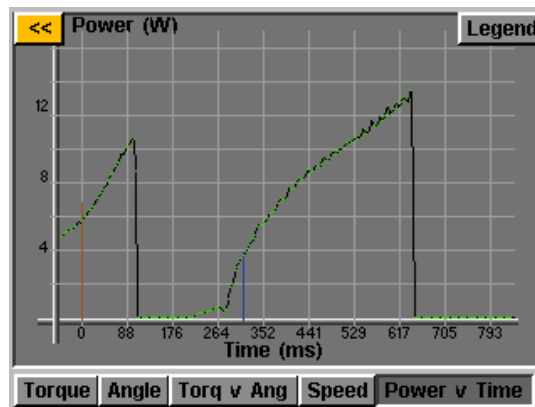

In each graph there is a 'Legend' button on the top of the screen. Tapping this button will affix labels to the lines overlaying each graph (where applicable) showing High Limits, Low Limits, Thresholds, etc as defined by the parameter of the rundown. The tool can be used while the controller displays the graph, just be aware that the graph will change with each cycle of the tool since the controller only stores the most recent rundown in graph form.



NOTE: The default view of each graph begins with Time or Angle equal to 0, which is defined by your Threshold set in the parameter of the rundown. Tapping on the graph once, will switch the view to a wider view that begins with the time the tool is triggered. Tap one more time to return to the original view.

Graph Data Export to USB

In order to enable the graph data export function, a key file must be saved to a USB flash drive and inserted to the controller. This file can be obtained from ASG and saved to the USB main directory inside a folder named 'Keys'.

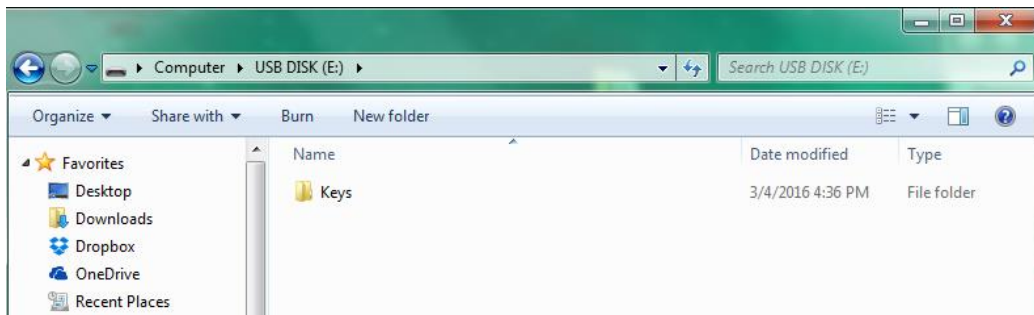

Once inserted, an icon will appear on the 'Run Tool' screen next to the 'Tool' button indicating the feature is enabled. Upon the completion of each rundown, the controller will export the graph data to the USB drive. It will be saved in the directory [Controller Name]\Graphs where [Controller Name] is whatever is programmed in under the 'Controller Info' menu.

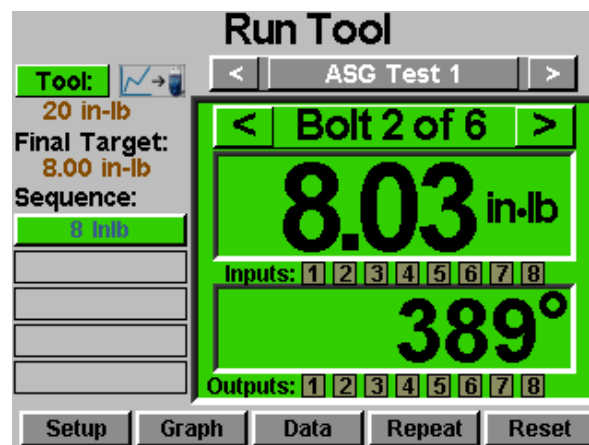

During the data export, a banner message will appear notifying the user that the export is in progress. It is not recommended that this feature be used during production because **the tool will not operate during the data export**. The tool will resume its normal operation once the export is complete.

The available data for export in this process is the following:

- Task Number
- Bolt Number
- Sequence Step
- Time (in ms since tool was triggered)
- Prevailing Torque
- Torque
- Torque Units
- Angle Total
- Angle since Threshold Torque

Data Screen

For data traceability, rundown information is stored in table form for view and download from the controller. To access this data, tap the 'Data' button on the bottom of the 'Run Tool' screen. The last 100 rundowns since the last controller reboot is available to view on screen. The data available to view on screen is:

- Date/Time
- Bolt Number
- Result (Good, High Torque, Low Angle, etc)
- Tool Cycle
- Target Torque/Angle
- Prevailing Torque
- Applied Torque (Sum of Final Torque and Prevailing Torque)
- Final Torque
- Final Angle

To page through the on-screen data, use the 'Next' and 'Previous' buttons available at the bottom of the screen.



	Target	Prevail	Applied	Final	Angle	Result
12/22/21						
1	540 deg	0.00	0.25	0.25	160	Low Angle
2	540 deg	0.00	0.25	0.25	311	Good
1	540 deg	0.00	0.37	0.37	311	Good
2	540 deg	0.00	0.35	0.35	537	Good
1	540 deg	0.00	0.00	0.00	0	Low Angle
2	540 deg	0.00	0.04	0.04	0	Low Angle
2	500 deg	0.00	0.39	0.39	144	Good
1	500 deg	0.00	0.02	0.02	0	Good

An expanded data set is stored in the controller's internal memory, the number of rundowns stored is limited only by the memory of the controller, and once filled is replaced in a first in/first out basis. Refer to the 'Downloading Data' section of this manual for more information on how to retrieve this data.



NOTE: Turning off the controller will clear the table of all data. The data is retained in memory for download, but will not be available for on-screen viewing.

The 'Steps' radio button will expand or collapse bolt sequence results for a given bolt.

Erasing Data

To erase the data shown on the screen, tap the 'Erase' button at the bottom of the chart. A screen will ask you to confirm your intentions to erase the data before the data is cleared. **NOTE:** Erasing the data with this button will not clear the data from the internal memory of the controller; it will merely remove it from view in the table. Any erased data is still available for download to USB as described in the next section.

Downloading Data

To download data to a USB flash drive, insert a flash drive with available memory into the port on the bottom of the controller. Tap the 'Export Data' button at the bottom of the data table, and then select either to download just the Data Screen Contents, or choose a date range for which you wish to download the data. Tap the 'Export' button to copy the information to the flash drive. The downloaded files are a CSV format (comma separated value) and will open automatically in typical spreadsheet programs.

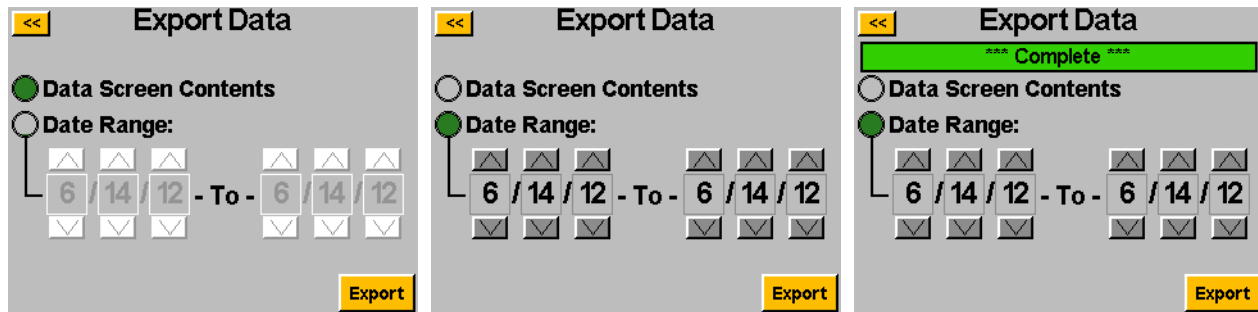

To view the data downloaded to USB, insert the flash drive into a computer and open to view the files and folders. The controller will create a folder on your flash drive called your controller name (if you have named your controller 'Station 1' in the 'Controller Information' screen, you will find a folder on your flash drive named 'Station 1'. See the Controller Information section of this manual for more information). Inside this folder will be a folder called 'Data' which contains the files exported to the flash drive. Note: if multiple days are selected for download, the controller will save a file for each day on the flash drive. For example, if 5 days are selected for data export, you will find 5 files on the flash drive (unless the tool was not used during some of those days).



NOTE: The data is organized in the controller's internal memory by the controller date. This date is set in the 'System Setup' menu. Be sure to have the controller date set correctly. Inaccurate date settings in the controller will result in data stored under the wrong date, making download of the correct data difficult.

Data available in these downloaded files includes the following:

- Date
- Time
- Tool Model Number
- Tool Serial Number
- Tool Cycle Number
- Task Name
- Bolt Number
- Torque Units
- Parameter Target
- Prevailing Torque Value
- Applied Torque
- Final Torque Reading
- Final Angle Reading
- Cycle Time
- Result Note
- Parameter Name
- Parameter Type
- Parameter Threshold Torque
- Parameter Torque HL
- Parameter Torque LL
- Parameter Angle HL
- Parameter Angle LL
- Downshift Torque
- Rundown Speed
- Downshift Speed
- Hand of Rotation

System Setup Screen

The 'System Setup' screen allows the user to set system controls and tool settings. See the following sections for further information.

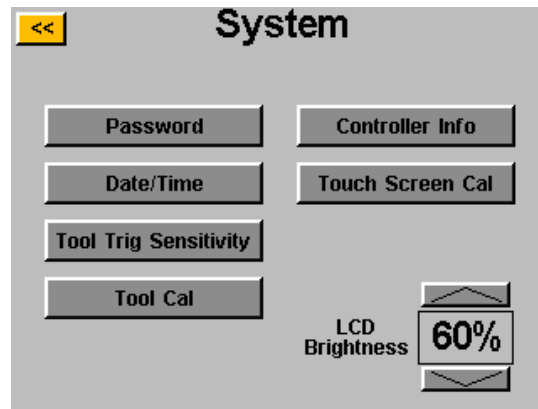

Passwords

From the 'System Setup' screen, tap the 'Passwords' button. The controller allows (3) individual passwords, each password allows access to the controller when locked. Each password allows full access to unlock the controller. When a controller is locked, the controller will still navigate to all screens and settings will be viewable. If it is locked and a user tries to access a protected field, the controller will prompt for a password to allow access.

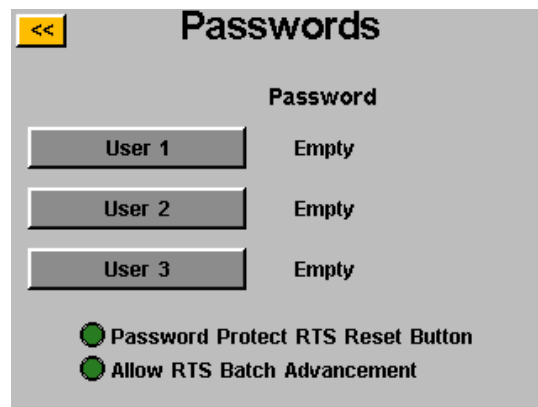

Radio Button Options:

- 'Password Protect RTS Reset Button' – enabling this feature prevents the 'Reset' button on the 'Run Tool' screen from being used without unlocking the controller
- 'Allow RTS Batch Advancement' – enabling this feature allows the batch advancement arrows around the bolt number area on the 'Run Tool' screen to be active when the controller is locked. When this feature is not enabled the arrow keys will not be visible.

Creating a User(s)/Password(s): Tap an available user button and enter a User Name when prompted. Next enter a password, and then confirm the password. The controller will return to the 'Passwords' screen, and the entered user name should be visible in one of the buttons. Return to the 'Setup' screen by tapping the [<<] button twice. You will notice that the screen appears differently than before, many of the fields are "greyed-out" signifying that the controller is locked and those fields are no longer accessible.

Modifying features in a locked controller: Navigate to the setting or feature that needs to be modified and tap the appropriate button or number. The controller will then prompt the user for a password to unlock the controller. Once a password is accepted, settings can be changed on any screen. To re-lock the controller again after modifications have been made, tap the 'Lock' button at the bottom right-hand corner of the 'Run Tool' screen.

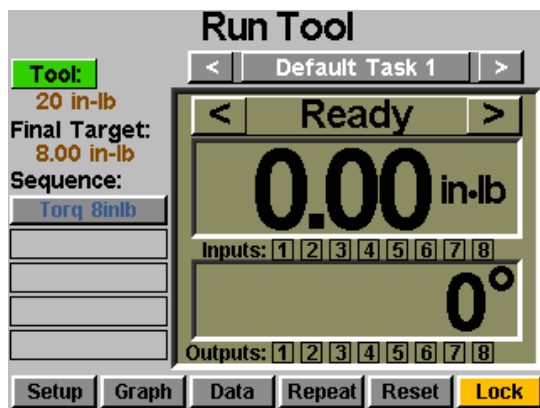

Deleting User(s)/Password(s): From the 'Passwords' screen, tap the name of the user that is to be deleted, enter the password when prompted. The screen will show that the password is now active, and create a button next to that user called 'Delete User'. Tap the 'Delete User' button to remove the user from the controller.

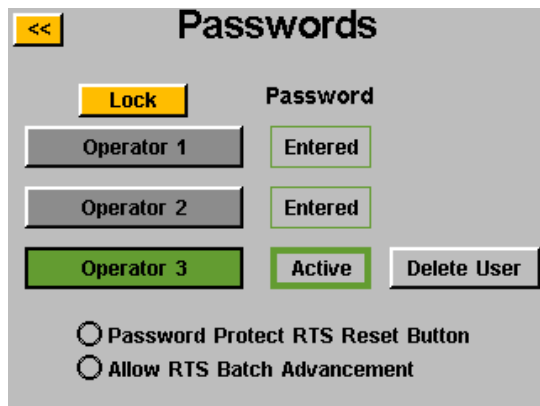

NOTE: It is recommended that one ID and password be programmed and stored in a safe location to prevent from accidental locking of the controller that is left unlocked. If all user passwords are lost or unknown, contact ASG Customer Service at asginfo@asg-jergens.com or your Regional Sales Team members for assistance.

Date/Time Settings

To set the controller's date and time, tap the 'Date/Time' button on the 'System Setup' screen. Adjust the date and time by tapping on each field and changing the value with the on-screen keypad. Note: the time is formatted in a 24 hour format, and the date is in MM/DD/YY format. Tap the [<<] button to return to the previous screen and save changes.

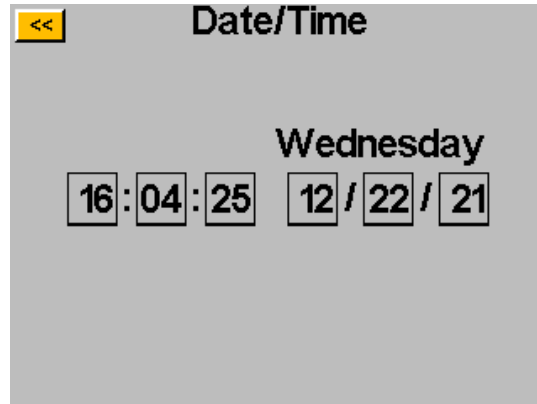

NOTE: The data is organized in the controller's internal memory by the controller date. This date is set in the 'System Setup' menu. Be sure to have the controller date set correctly. Inaccurate date settings in the controller will result in data stored under the wrong date, making download of the correct data difficult.

Tool Trigger Sensitivity

The controller allows the user to set the sensitivity of both the Push-to-Start and the Lever Start (when equipped) features of the ASG-SD2500 tool to suit individual user or application preferences. To adjust these settings, tap the 'Tool Trig Sensitivity' button on the 'System' screen.

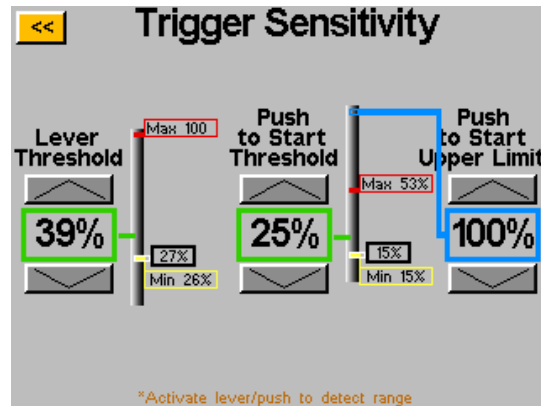

On the 'Trigger Sensitivity' screen there are two slider bars, one for the Lever, and one for the Push-to-Start. On each slider there is the following:

- Yellow bar – shows the minimum trigger reading
- Red bar – shows the maximum trigger reading
- White bar – shows the current trigger reading
- Green bar - shows the trigger reading threshold
- Blue bar – shows the upper limit for push to start activation

The minimum and maximum readings on each trigger are reset when the controller power is reset. Actuating each trigger after a power cycle will reset the readings on the sensitivity screen.

To adjust the threshold, use the up and down arrow keys to move the green bar up or down the slider. To test, push the lever or pull chuck to move the white bar up to the green threshold bar and verify the tool begins to run when desired.

If the push to start value exceeds the upper limit value during a fastening cycle the driver will stop running. The driver will not run again until the push to start reading falls below the threshold, then crosses it once again.

Tool Calibration

To view the calibration value of the tool connected to the controller, tap the 'Tool Cal' button on the 'System' screen. The calibration value will be displayed, and can be modified if required.

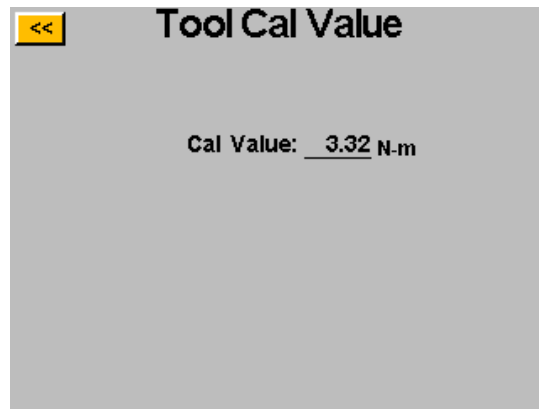

CAUTION: Tapping on the Calibration Value will take you to a screen where the value can be manually changed. This screen is for qualified calibration technicians only. Improperly changing the calibration value of the tool could lead to inaccurate torque readings and potential tool damage.

Controller Information

To view basic information about the controller and to give the controller a name, tap the 'Controller Info' button on the 'System' screen. This screen displays the following:

- Controller Name
- Controller Serial Number
- GUI Board Firmware Version
- Controller Board Firmware Version

Changing the Controller Name: To change the controller name, tap the button on the 'Controller Information' screen that shows the current name, and then enter the new name on the screen.

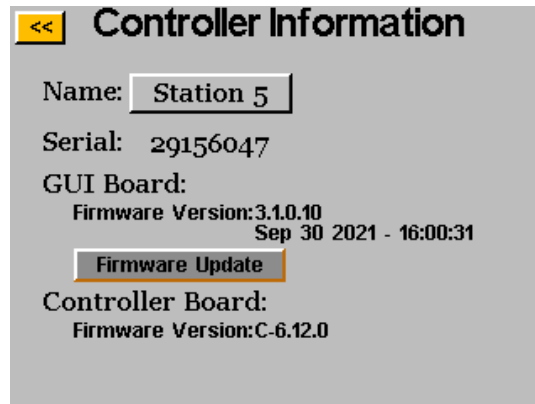

NOTE: When exporting data to a USB flash drive from the controller, the name of the folder created on that flash drive will be the same name as the controller. This will assist the user if downloading data from multiple controllers onto one single flash drive. See the Data Screen section for more information on downloading data to USB.

Firmware Update

When a USB flash drive is inserted to the controller, the 'Firmware Update' button is active on the 'Controller Information' screen. Tapping the button will allow you to navigate to the flash drive and select a file to upload to the controller. The firmware file can be obtained from ASG, contact ASG Customer Service for more information and eligibility.



The USB flash drive must be FAT32 formatted for this feature to work properly. Failure to use a properly formatted flash drive can result in firmware corruption and require the controller to be serviced at ASG to reset it to proper function.

Touch Screen Calibration

Should the user feel the need to recalibrate the touch screen, this option is available under the 'System' screen. Tap the 'Touch Screen Cal' button and follow the on-screen directions to complete this process.

LCD Brightness

Should the controller be used in extremely dark or light environments, the LCD touch screen brightness can be adjusted under the 'System' screen. Use the up and down arrow buttons to adjust the brightness. The controller comes factory set at 60%.

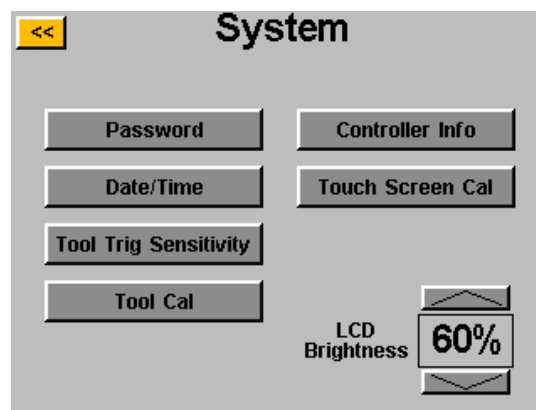

Service & Warranty

Service

Should a product need to be returned for any reason, please contact ASG for a return authorization number prior to shipping an item for repair. Call us at (888) 486-6163 or email us at asginfo@asg-jergens.com

- No items will be received without prior authorization
- Be sure to include a brief description of the problem, your company name, address, phone number and contact name
- An ASG technician will contact you with a quotation and information regarding your repair

Warranty

ASG Precision Fastening warrants to the original purchaser buying an ASG-SD2500 product with the intention of use rather than for resale, for a period of one (1) year from the first in-service date or one million (1,000,000) cycles.

Within the warranty period, ASG Precision Fastening will replace or repair those items found to be defective or otherwise fail to conform. The buyer's remedies with respect to any item found to be defective or otherwise not conforming shall be limited EXCLUSIVELY to the right of replacement. In no event shall ASG be liable for any incidental special or consequential damages or for damages in the nature of penalties.

Disclaimer: Seller makes no other warranty whatever, expressed or implied, and all implied warranties of merchantability and fitness for a particular purpose are disclaimed and excluded from this transaction and shall not apply to the goods sold hereunder.