

---

# HP 8753E RF Vector Network Analyzer

## Technical Specifications

---

**30 kHz to 3 GHz or 6 GHz**

---

The HP 8753E RF vector network analyzer provides all the performance and productivity features to simplify and speed your component measurements in the 30 kHz to 6 GHz frequency range. Its new processor makes measurement and data-transfer speeds up to seven times faster than the previous model. Overall throughput is enhanced by new features such as simultaneous four parameter display\* and adapter-removal calibration. An integrated, synthesized source provides up to 10 mW of output power (100 mW for Option 011), 1 Hz frequency resolution, and linear-frequency, log-frequency, list-frequency, CW, and power sweep types. Three tuned receivers allow independent power measurements or simultaneous ratio measurements over a wide dynamic range of 105 dB at 6 GHz (with Option 006 frequency extension) or 110 dB at 3 GHz (standard). The integrated test set allows you to measure transmission and reflection characteristics of a device to 6 GHz, without a frequency doubler.

The HP 8753E network analyzer features two independent measurement channels. You can choose to display any combination of reflection and transmission parameters, in magnitude, phase, group-delay, Smith-chart, polar, SWR, or time-domain formats. Softkeys let you quickly access measurement functions, and you can view results in overlay or split-screen format on the LCD color display. A VGA-compatible output has been added to drive larger external monitors for optimum viewing.

### HP 8753E maximizes versatility and performance

- Frequency range from 30 kHz to 3 GHz, or optionally 6 GHz.
- Built-in S-parameter test set provides complete forward and reverse measurements, allowing you to characterize your component with a single connection.
- 50 and 75-ohm solutions.
- Superb accuracy. Comprehensive calibration guarantees accurate measurements. TRL\*/LRM\* make calibration in noncoaxial environments easier and more convenient.
- Mixer testing. Quickly and easily characterize frequency translating devices such as mixers.
- Add swept harmonic measurements. Characterize amplifier parameters — gain, 1 dB compression, match — and 2nd and 3rd harmonic distortion with the same test setup.
- Built-in 3.5 inch floppy disk drive provides convenient storage of instrument states and data.
- Parallel and serial ports provide interfaces to popular printers and plotters. The parallel port can also be used as a general I/O bus, with user controllable TTL inputs and outputs. Users can also connect a DIN keyboard to speed up entry of titles, labels, or file names, and for remote front panel operation.

\*available Q298

## Definitions and test conditions

This document provides two types of performance information:

*Specifications* describe the instrument's warranted performance over the temperature range of  $23 \pm 3^\circ \text{C}$ , unless otherwise stated. Specifications for frequencies above 3 GHz do not apply to instruments with Option 075 (75-ohm impedance).

*Supplemental characteristics* are typical but non-warranted performance parameters. These are denoted as "typical," "nominal," or "approximate."

### Dynamic range

*System dynamic range* is the noise level relative to a "through." It is calculated as the difference between the maximum receiver input level and the receiver's noise floor. System dynamic range applies to transmission measurements only, since reflection measurements are limited by directivity.

Noise floor is specified as the mean of the noise trace over frequency. A signal at this level would have a signal/noise power ratio of 3 dB. Noise floor is measured with the test ports terminated in loads, full two-port error correction (with 16 averages used during isolation), 10 Hz IF bandwidth (BW), maximum test port power, and no averaging during the measurement.

### Measurement uncertainty

Curves show the worst-case magnitude and phase uncertainty for reflection and transmission measurements, after a full two-port calibration (including isolation with an averaging factor of 16) using the specified cal kit, with 10 Hz IF bandwidth (BW) and no averaging.

*Calibration* is the process of measuring known standards from a calibration kit to characterize a network analyzer's systematic (repeatable) errors.

*Reflection measurement uncertainty* is plotted as a function of  $S_{11}$  (reflection coefficient, linear). The curves assume a one-port device ( $S_{21}=S_{12}=0$ ).

*Transmission measurement uncertainty* is plotted as a function of  $S_{21}$  (transmission gain/loss) in dB from the reference level. The curves assume that the device is well-matched ( $S_{11}=S_{22}=0$ ).

The reference level for HP 8753E measurements is -10 dBm test port power.

### Measurement port characteristics

*Corrected (residual)* indicates performance after error correction (calibration). It is determined by the quality of calibration standards and how well "known" they are, plus system repeatability, stability, and noise.

*Uncorrected (raw)* indicates intrinsic performance without error correction. This is related to the ultimate stability of a calibration.

### Organization of data

The information in this document is organized into the following sections. All data is subject to change.

#### System performance summary

The measurement uncertainty curves and measurement port characteristics given for HP 8753E systems also apply to the HP 8753E with Options 006 and 011 and the HP 85047A test set (50-ohm), or the HP 8753E Option 011 with an HP 85046B test set (75-ohm).

#### Test-port output characteristics

#### Test-port input characteristics

Separate sections are provided for an HP 8753E (no Option 011), and HP 8753E with Option 011.

#### Supplemental characteristics

#### HP 8753E test set specifications

This section provides information on test sets that are available for use with the HP 8753E Option 011.

#### HP 8753E accessories

These sections contain information about calibration kits, cables, adapters, and other accessories.

## System performance summary HP 8753E (50-ohm systems) 7-mm test ports

The following specifications describe the system performance of the HP 8753E network analyzer with an integrated 50-ohm S-parameter test set configuration. System hardware includes the following:

Network analyzer	HP 8753E Option 006
Calibration kit	HP 85031B
Test-port cables	HP 11857D

### Dynamic range

These specifications apply to transmission measurements in the 30 kHz to 6 GHz frequency range at 10 Hz IF BW with full two-port error correction. Dynamic range is limited by maximum receiver input level and the receiver's noise floor.

### System dynamic range

30 kHz to 300 kHz	100 dB <sup>1,6</sup>
300 kHz to 1.3 GHz	110 dB <sup>2</sup>
1.3 GHz to 3 GHz	110 dB
3 GHz to 6 GHz	105 dB

### Specified measurement uncertainty<sup>3</sup>

The following graphs show the specified measurement uncertainty for the HP 8753E over the full frequency range using full two-port error correction.

### Transmission measurements

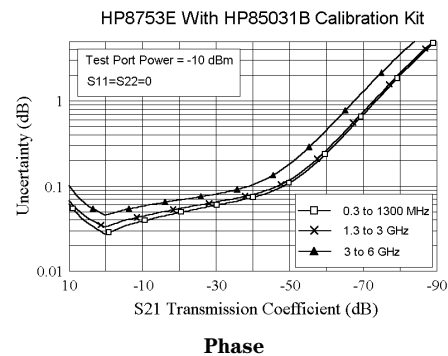
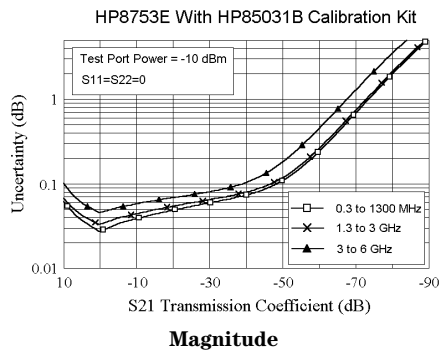

### Reflection measurements<sup>4</sup>

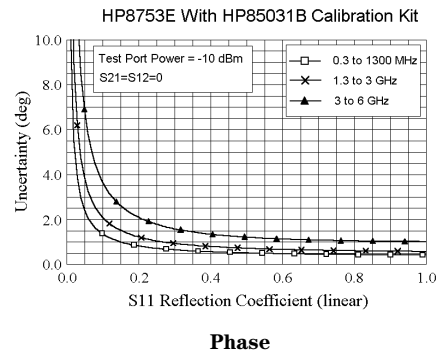
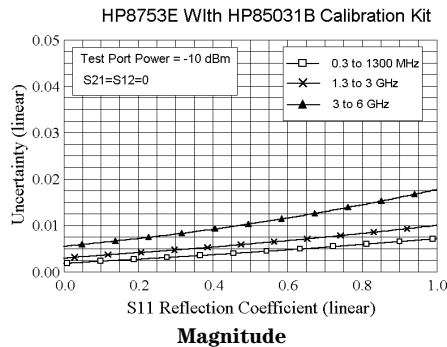

### Measurement port characteristics

The following specifications show the residual HP 8753E system uncertainties for uncorrected performance and after accuracy enhancement using full two-port error correction. These characteristics apply for an environmental temperature of  $25 \pm 5^\circ \text{C}$ , with less than  $1^\circ \text{C}$  deviation from the calibration temperature.

	Frequency Range			
	30 kHz-300 kHz <sup>5</sup>	300 kHz-1.3 GHz	1.3 GHz-3 GHz	3 GHz-6 GHz
<b>Corrected</b>				
Directivity	55 dB	55 dB	51 dB	46 dB
Source Match	55 dB	51 dB	49 dB	43 dB
Load Match	55 dB	55 dB	51 dB	46 dB
Reflection tracking	$\pm 0.001$ dB	$\pm 0.001$ dB	$\pm 0.005$ dB	$\pm 0.020$ dB
Transmission tracking	$\pm 0.008$ dB	$\pm 0.006$ dB	$\pm 0.009$ dB	$\pm 0.021$ dB
<b>Uncorrected<sup>5</sup></b>				
Directivity	20 dB*	35 dB	30 dB	25 dB
Source Match	18 dB**	16 dB	16 dB	14 dB
Load Match	20 dB**	18 dB	16 dB	14 dB
Reflection tracking	$\pm 2.0$ dB	$\pm 1.5$ dB	$\pm 1.5$ dB	$\pm 2.5$ dB
Transmission tracking	$\pm 2.0$ dB	$\pm 1.5$ dB	$\pm 1.5$ dB	$\pm 2.5$ dB
Crosstalk	90 dB	100 dB	100 dB	90 dB

\*15 dB, 30 kHz to 50 kHz

\*\*10 dB, 30 kHz to 50 kHz

- 90 dB, 30 kHz to 50 kHz.
- 100 dB, 300 kHz to 16 MHz due to fixed spurs.
- These measurement uncertainty curves utilize an RSS model for the contribution of random errors such as noise, typical connector repeatabilities, and test set switch; with a worst-case model for the contributions of dynamic accuracy and residual systematic errors.
- The graphs shown for reflection measurements apply to either a one-port device or a two-port device with more than 6 dB insertion loss.
- Typical performance.
- Typical below 300 kHz.

## System performance summary HP 8753E (50-ohm systems) type-N test ports

The following specifications describe the system performance of the HP 8753E network analyzer with an integrated 50-ohm S-parameter test set configuration. System hardware includes the following:

Network analyzer	HP 8753E Option 006
Calibration kit	HP 85032B
Test-port cables	HP 11857D

### Dynamic range

These specifications apply to transmission measurements in the 30 kHz to 6 GHz frequency range at 10 Hz IF BW with full two-port error correction. Dynamic range is limited by maximum receiver input level and the receiver's noise floor.

### System dynamic range

30 kHz to 300 kHz	100 dB <sup>1,5</sup>
300 kHz to 1.3 GHz	110 dB <sup>2</sup>
1.3 GHz to 3 GHz	110 dB
3 GHz to 6 GHz	105 dB

### Typical measurement uncertainty<sup>3</sup>

The following graphs show the typical measurement uncertainty for the HP 8753E over the full frequency range using full two-port error correction.

### Transmission measurements

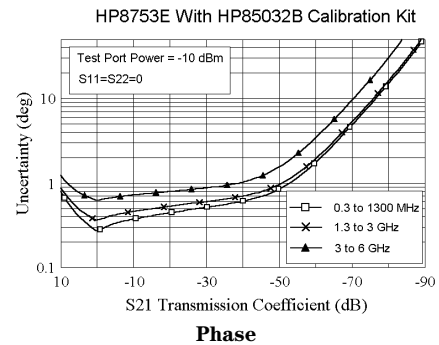
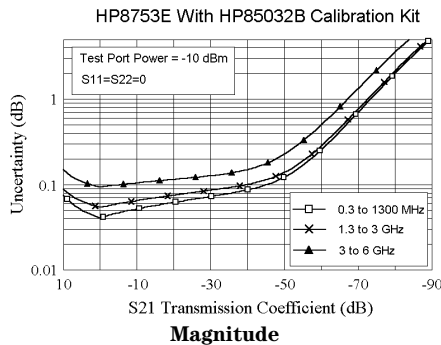

### Reflection measurements<sup>4</sup>

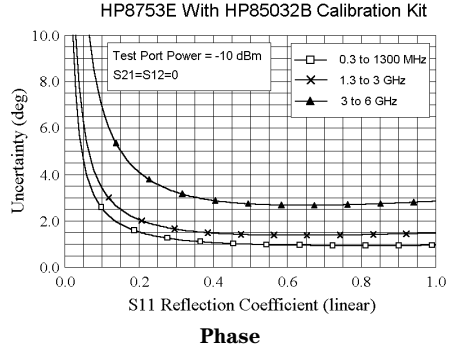
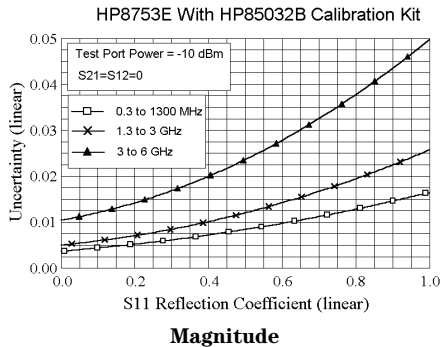

### Measurement port characteristics

The following specifications show the residual HP 8753E system uncertainties for corrected performance after accuracy enhancement using full two-port error correction. These characteristics apply for an environmental temperature of  $25 \pm 5^\circ\text{C}$ , with less than  $1^\circ\text{C}$  deviation from the calibration temperature.

Corrected	Frequency range			
	30 kHz-300 kHz <sup>5</sup>	300 kHz-1.3 GHz	1.3 GHz-3 GHz	3 GHz-6 GHz
Directivity	50 dB	50 dB	47 dB	40 dB
Source match	49 dB	42 dB	36 dB	31 dB
Load match	50 dB	50 dB	47 dB	40 dB
Reflection tracking	$\pm 0.005$ dB	$\pm 0.009$ dB	$\pm 0.019$ dB	$\pm 0.070$ dB
Transmission tracking	$\pm 0.014$ dB	$\pm 0.013$ dB	$\pm 0.026$ dB	$\pm 0.065$ dB

- 90 dB, 30 kHz to 50 kHz.
- 100 dB, 300 kHz to 16 MHz due to fixed spurs.
- These measurement uncertainty curves utilize an RSS model for the contribution of random errors such as noise, typical connector repeatabilities, and test set switch; with a worst-case model for the contributions of dynamic accuracy and residual systematic errors.
- The graphs shown for transmission measurements assume a well-matched device ( $S_{11} = S_{22} = 0$ ).
- Typical below 300 kHz.

## System performance summary HP 8753E (50-ohm systems) 3.5-mm test ports

The following specifications describe the system performance of the HP 8753E network analyzer with an integrated 50-ohm S-parameter test set configuration. System hardware includes the following:

Network analyzer	HP 8753E Option 006
Calibration kit	HP 85033D
Test-port cables	HP 11857D

### Dynamic range

These specifications apply to transmission measurements in the 30 kHz to 6 GHz frequency range at 10 Hz IF BW with full two-port error correction. Dynamic range is limited by maximum receiver input level and the receiver's noise floor.

### System dynamic range

30 kHz to 300 kHz	100 dB <sup>1,5</sup>
300 kHz to 1.3 GHz	110 dB <sup>2</sup>
1.3 GHz to 3 GHz	110 dB
3 GHz to 6 GHz	105 dB

### Typical measurement uncertainty<sup>3</sup>

The following graphs show the typical measurement uncertainty for the HP 8753E over the full frequency range using full two-port error correction.

### Transmission measurements

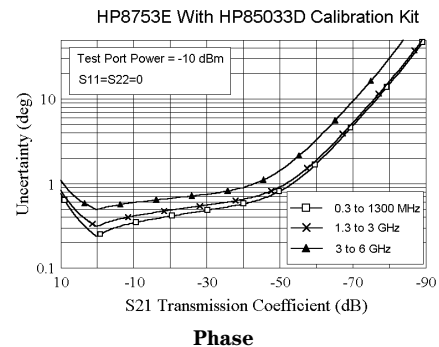
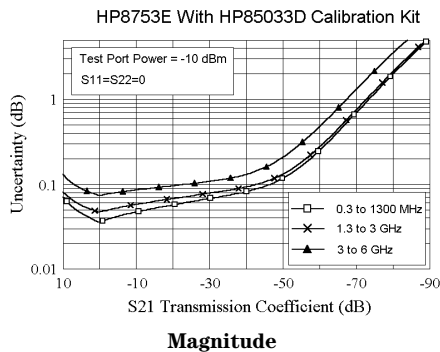

### Reflection measurements<sup>4</sup>

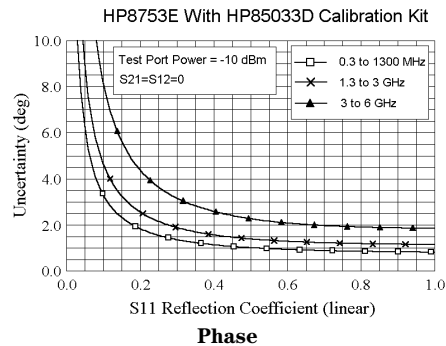
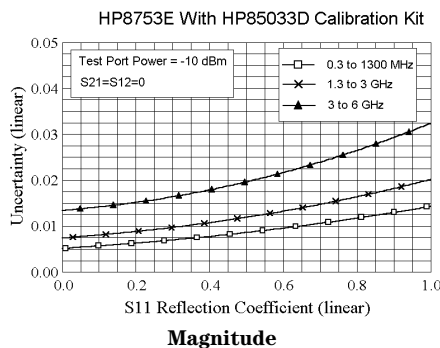

- 90 dB, 30 kHz to 50 kHz.
- 100 dB, 300 kHz to 16 MHz due to fixed spurs.
- These measurement uncertainty curves utilize an RSS model for the contribution of random errors such as noise, typical connector repeatabilities, and test set switch; with a worst-case model for the contributions of dynamic accuracy and residual systematic errors.
- The graphs shown for reflection measurements apply to either a one-port device or a two-port device with more than 6 dB insertion loss.
- Typical below 300 kHz.

### Measurement port characteristics

The following specifications show the residual HP 8753E system uncertainties for corrected performance after accuracy enhancement using full two-port error correction. These characteristics apply for an environmental temperature of  $25 \pm 5^\circ\text{C}$ , with less than  $1^\circ\text{C}$  deviation from the calibration temperature.

Corrected	Frequency Range			
	30 kHz-300 kHz <sup>5</sup>	300 kHz-1.3 GHz	1.3 GHz-3 GHz	3 GHz-6 GHz
Directivity	49 dB	46 dB	44 dB	38 dB
Source Match	49 dB	44 dB	41 dB	37 dB
Load Match	49 dB	46 dB	44 dB	38 dB
Reflection tracking	$\pm 0.010$ dB	$\pm 0.005$ dB	$\pm 0.007$ dB	$\pm 0.009$ dB
Transmission tracking	$\pm 0.016$ dB	$\pm 0.014$ dB	$\pm 0.022$ dB	$\pm 0.048$ dB

## System performance summary HP 8753E (75-ohm systems) type-N test ports

The following specifications describe the system performance of the HP 8753E network analyzer with an integrated 75-ohm S-parameter test configuration. System hardware includes the following:

Network analyzer	HP 8753E Option 075
Calibration kit	HP 85036B
Test-port cables	HP 11857B

### Dynamic range

These specifications apply to transmission measurements in the 30 kHz to 3 GHz frequency range at 10 Hz IF BW with full two-port error correction. Dynamic range is limited by maximum receiver input level and the receivers noise floor.

### System dynamic range

30 kHz to 300 kHz	95 dB <sup>1,6</sup>
300 kHz to 1.3 GHz	105 dB <sup>2</sup>
1.3 GHz to 3 GHz	105 dB

### Typical measurement uncertainty<sup>3</sup>

The following graphs show the typical measurement uncertainty for the HP 8753E over the full frequency range using full two-port error correction.

### Transmission measurements

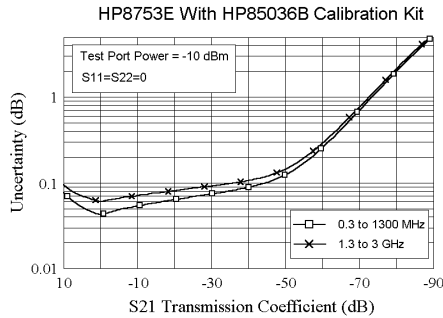

Magnitude

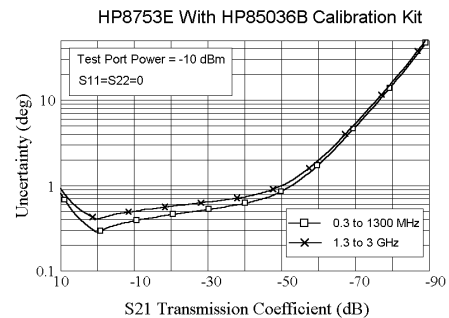

Phase

### Reflection measurements<sup>4</sup>

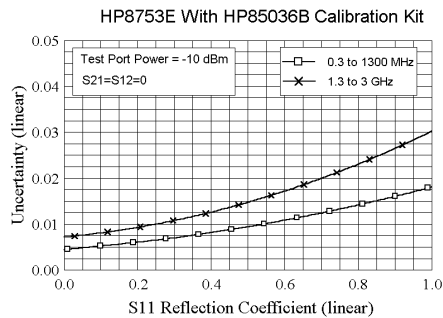

Magnitude

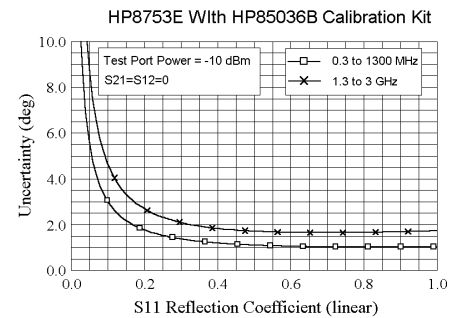

Phase

### Measurement port characteristics

The following specifications show the residual HP 8753E system uncertainties for uncorrected performance and after accuracy enhancement using full two-port error correction. These characteristics apply for an environmental temperature of  $25 \pm 5^\circ\text{C}$ , with less than  $1^\circ\text{C}$  deviation from the calibration temperature.

	Frequency Range		
Corrected <sup>5</sup>	30 kHz - 300 kHz	300 kHz - 1.3 GHz	1.3 GHz - 3 GHz
Directivity	48 dB	48 dB	43 dB
Source Match	47 dB	41 dB	35 dB
Load Match	48 dB	48 dB	43 dB
Reflection tracking	$\pm 0.004$ dB	$\pm 0.010$ dB	$\pm 0.019$ dB
Transmission tracking	$\pm 0.018$ dB	$\pm 0.015$ dB	$\pm 0.033$ dB
Uncorrected <sup>5</sup>			
Directivity	20 dB <sup>7</sup>	35 dB	30 dB
Source Match	10 dB	16 dB	16 dB
Load Match	14 dB	18 dB	16 dB
Reflection tracking	$\pm 2.0$ dB	$\pm 1.5$ dB	$\pm 1.5$ dB
Transmission tracking	$\pm 2.0$ dB	$\pm 1.5$ dB	$\pm 1.5$ dB
Crosstalk	90 dB	100 dB	100 dB

- 90 dB, 30 kHz to 50 kHz.
- 100 dB, 300 kHz to 16 MHz due to fixed spurs.
- These measurement uncertainty curves utilize an RSS model for the contribution of random errors such as noise, typical connector repeatabilities, and test set switch; with a worst-case model for the contributions of dynamic accuracy and residual systematic errors.
- The graphs shown for reflection measurements apply to either a one-port device or a two-port device with more than 6 dB insertion loss.
- Typical performance.
- Typical below 300 kHz.
- 15 dB from 30 to 50 kHz.

## System performance summary HP 8753E (75-ohm systems) type-F test ports

The following specifications describe the system performance of the HP 8753E network analyzer with an integrated 75-ohm S-parameter test configuration. System hardware includes the following:

Network analyzer	HP 8753E Option 075
Calibration kit	HP 85039B
Test-port cables	HP 11857B

### Dynamic range

These specifications apply to transmission measurements in the 30 kHz to 3 GHz frequency range at 10 Hz IF BW with full two-port error correction. Dynamic range is limited by maximum receiver input level and the receivers noise floor.

### System dynamic range

30 kHz to 300 kHz	95 dB <sup>1,6</sup>
300 kHz to 1.3 GHz	105 dB <sup>2</sup>
1.3 GHz to 3 GHz	105 dB

### Typical measurement uncertainty<sup>3</sup>

The following graphs show the typical measurement uncertainty for the HP 8753E over the full frequency range using full two-port error correction.

### Transmission measurements

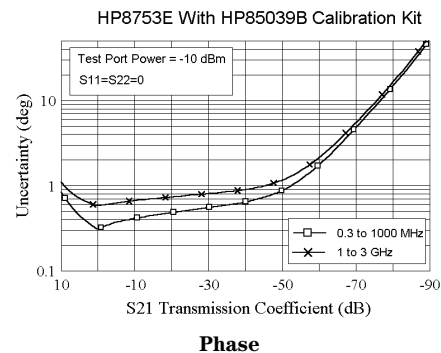
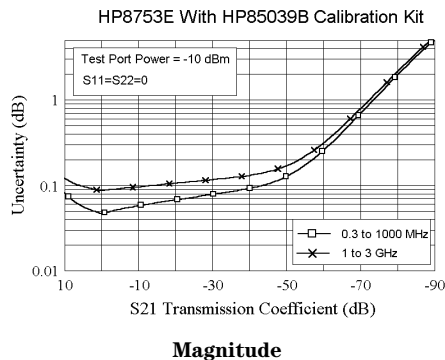

### Reflection measurements<sup>4</sup>

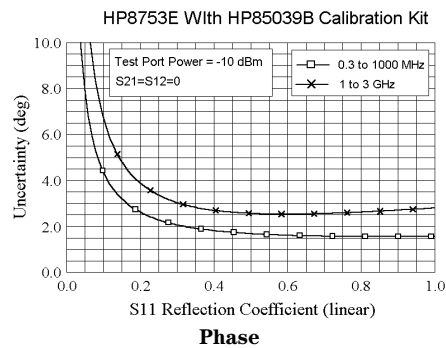
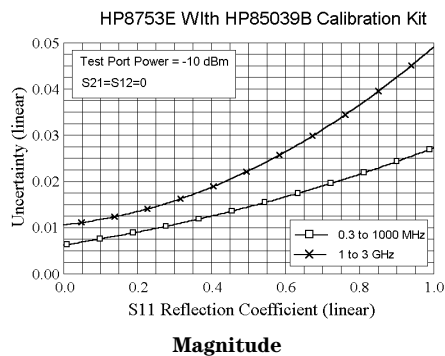

### Measurement port characteristics

The following specifications show the residual HP 8753E system uncertainties for uncorrected performance and after accuracy enhancement using full two-port error correction. These characteristics apply for an environmental temperature of  $25 \pm 5^\circ \text{C}$ , with less than  $1^\circ \text{C}$  deviation from the calibration temperature. Data is shown for type-F female reflection port and type-F male transmission port.

	Frequency Range		
Corrected <sup>5</sup>	30 kHz-300 kHz	300 kHz-1.3 GHz	1.3 GHz-3 GHz
Directivity	38 dB	38 dB	32 dB
Source Match	36 dB	36 dB	30 dB
Load Match	38 dB	38 dB	32 dB
Reflection tracking	$\pm 0.008 \text{ dB}$	$\pm 0.008 \text{ dB}$	$\pm 0.032 \text{ dB}$
Transmission tracking	$\pm 0.062 \text{ dB}$	$\pm 0.035 \text{ dB}$	$\pm 0.078 \text{ dB}$

- 90 dB, 30 kHz to 50 kHz.
- 100 dB, 300 kHz to 16 MHz due to fixed spurs.
- These measurement uncertainty curves utilize an RSS model for the contribution of random errors such as noise, typical connector repeatabilities, and test set switch; with a worst-case model for the contributions of dynamic accuracy and residual systematic errors.
- The graphs shown for reflection measurements apply to either a one-port device or a two-port device with more than 6 dB insertion loss.
- Typical performance.
- Typical below 300 kHz.

## HP 8753E specifications

### Test-port output characteristics<sup>7</sup>

#### Frequency characteristics

<b>Range</b>	30 kHz to 3 GHz (6 GHz with Opt. 006)
<b>Resolution</b>	1 Hz
<b>Stability</b>	typically $\pm 7.5$ ppm $0^\circ$ to $55^\circ$ C typically $\pm 3$ ppm/year

#### With Option 1D5

typically  $\pm 0.05$  ppm  $0^\circ$  to  $55^\circ$  C  
typically  $\pm 0.5$  ppm/year

<b>Accuracy</b>	$\pm 10$ ppm at $25^\circ$ C $\pm 5^\circ$ C
<b>Power range</b>	-85 to +10 dBm <sup>2,6</sup>
<b>Resolution</b>	0.05 dB
<b>Level accuracy<sup>1,2,5</sup></b>	$\pm 1.0$ dB
<b>Level linearity<sup>1,2,5</sup></b>	(-15 dBm to +5 dBm) $\pm 0.2$ dB (5 dBm to 10dBm) <sup>6</sup> $\pm 0.5$ dB
<b>Impedance</b>	50 $\Omega$ ; typically $\geq 16$ dB RL (<1.38 SWR) to 3 GHz $\geq 14$ dB RL (<1.50 SWR) to 6 GHz

#### Spectral purity

<b>2nd harmonic<sup>3</sup></b>	<-25 dBc at $10^6$ dBm <-40 dBc at 0 dBm (typical) <-50 dBc at -10 dBm (typical)
<b>3rd harmonic<sup>4</sup></b>	<-25 dBc at $10^6$ dBm <-40 dBc at 0 dBm (typical) <-50 dBc at -10 dBm (typical)

#### Nonharmonic spurious

<b>Mixer related</b>	<-30 dBc at $10^6$ dBm (typical) <-55 dBc at -10 dBm (typical)
----------------------	---

### Test port input characteristics

<b>Frequency range</b>	30 kHz to 3 GHz (6 GHz with Opt. 006)
<b>Average noise level<sup>2</sup></b>	-82 dBm (3 kHz BW, <3 GHz) -102 dBm (10 Hz BW, <3 GHz) -110 dBm (10 Hz BW, <3 GHz) (typical) -77 dBm (3 kHz BW, 3 to 6 GHz) -97 dBm (10 Hz BW, 3 to 6 GHz) -105 dBm (10 Hz BW, 3 to 6 GHz) (typical)

<b>Maximum input level</b>	10 dBm
<b>Damage level</b>	26 dBm or 35 VDC
<b>Impedance, 50 ohms</b>	>10 dB RL, 30 kHz to 50 kHz <sup>2</sup> >20 dB RL, 50 kHz to 300 kHz <sup>2</sup> >18 dB RL, 300 kHz to 1.3 GHz >16 dB RL, 1.3 GHz to 3 GHz >14 dB RL, 3 GHz to 6 GHz
<b>Frequency response<sup>2,5</sup></b> ( $25^\circ + 5^\circ$ C)	$\pm 1.0$ dB, 300 kHz to 3 GHz $\pm 2.0$ dB, 3 GHz to 6 GHz

#### Harmonics (Option 002)

<b>2nd harmonic<sup>3</sup></b>	<-15 dBc at +8 dBm <-35 dBc at 0 dBm (typical) <-45 dBc at -15 dBm (typical)
<b>3rd harmonic<sup>4</sup></b>	<-30 dBc at +8 dBm <-50 dBc at 0 dBm (typical) <-50 dBc at -15 dBm (typical)

#### Harmonic measurement accuracy ( $25^\circ \pm 5^\circ$ C)

16 MHz to 3 GHz	$\pm 1.5$ dB
3 GHz to 6 GHz	$\pm 3$ dB (with Opt. 006)

#### Harmonic measurement dynamic range

-40 dBc (output = -10 dBm,  
input = <-15 dBm)

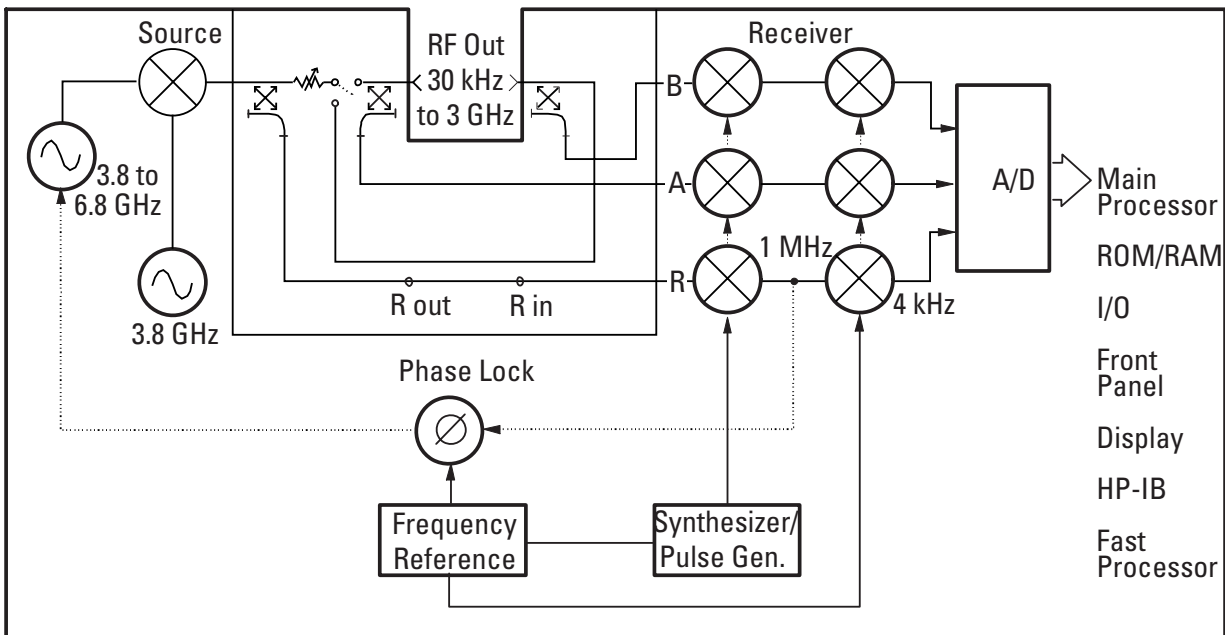

HP 8753E block diagram

- At  $25^\circ$  C  $\pm 5^\circ$  C, relative to 0 dBm output power for the HP 8753E, +10 dBm output power for the HP 8753E Option 011.
- Typical below 300 kHz.
- 16 MHz to 3 GHz.
- 16 MHz to 2 GHz.
- Typical from 2 to 3 GHz for instruments with Option 075.
- +8 dBm with Option 075.
- Test performed on port 1 only.



## HP 8753E specifications

### Test-port input characteristics (continued)

#### Frequency offset mode<sup>3</sup>

Frequency range	300 kHz to 3 GHz (6 GHz with Opt. 006)
-----------------	---

#### R channel input requirements

Power level	0 to -35 dBm to 3 GHz 0 to -30 dBm, 3 GHz to 6 GHz
-------------	---

#### Spectral purity

Maximum spurious input	<-25 dBc
------------------------	----------

Residual FM	<20 kHz
-------------	---------

LO frequency accuracy	-1 to +1 MHz of nominal frequency
-----------------------	-----------------------------------

#### External source mode<sup>4</sup> (CW time sweep only)

Frequency range	300 kHz to 6 GHz
-----------------	------------------

#### R channel input requirements<sup>1</sup>

Power level	0 to -25 dBm
-------------	--------------

#### Spectral purity

Maximum spurious input	<-30 dBc
------------------------	----------

Residual FM	<20 kHz
-------------	---------

Typical settling time	500 ms (automatic) 50 ms (manual)
-----------------------	--------------------------------------

Frequency readout accuracy	0.1% typical (automatic)
----------------------------	--------------------------

Input frequency margin <sup>1</sup>	Manual: -0.5 to 5 MHz Automatic: <50 MHz, $\pm 5$ MHz >50 MHz, $\pm 10\%$ CW frequency (See magnitude and phase characteristics)
-------------------------------------	---

#### Accuracy

### Magnitude characteristics

#### Dynamic accuracy (10 Hz IF BW)

HP8753E Magnitude Dynamic Accuracy 0.3 to 3000 MHz

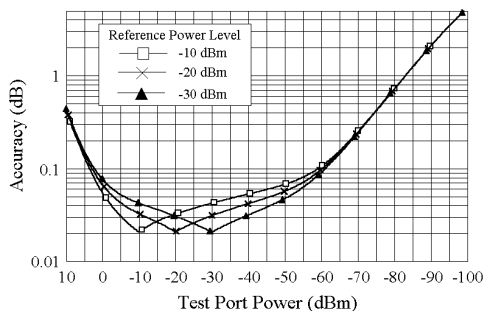

HP8753E Magnitude Dynamic Accuracy 3-6 GHz

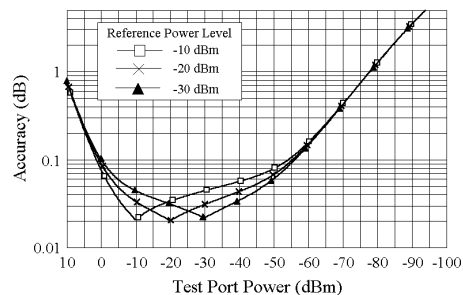

Display resolution	0.001 dB/division
Marker resolution <sup>5</sup>	0.001 dB
Trace noise <sup>2</sup>	< 0.006 dB rms, 30 kHz to 3 GHz < 0.010 dB rms, 3 GHz to 6 GHz (+5 dBm at test-port, ratio measurement, 3 kHz BW)
Reference level	Range: $\pm 500$ dB Resolution: 0.001 dB
Stability <sup>2</sup>	0.02 dB/ $^{\circ}$ C, 30 kHz to 3 GHz (typical) 0.04 dB/ $^{\circ}$ C, 3 GHz to 6 GHz (typical)

### Phase characteristics

#### Dynamic accuracy (10 Hz IF BW)

HP8753E Phase Dynamic Accuracy 0.3 to 3000 MHz

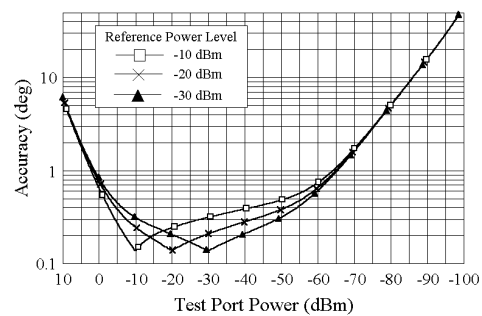

HP8753E Phase Dynamic Accuracy 3-6 GHz

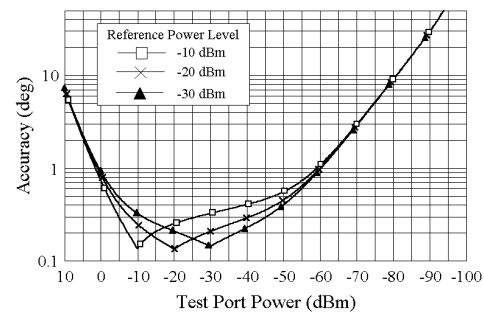

Range	$\pm 180^{\circ}$
Display resolution	0.01 $^{\circ}$ / division
Marker resolution <sup>5</sup>	0.01 $^{\circ}$
Trace noise <sup>2</sup>	< 0.038 $^{\circ}$ rms to 3 GHz < 0.070 $^{\circ}$ rms to 6 GHz (5 dBm at test-port, ratio measurement, 3 kHz BW)
Reference level	Range: $\pm 500^{\circ}$ Resolution 0.01 $^{\circ}$
Stability	0.05 $^{\circ}$ / $^{\circ}$ C, 30 kHz to 3 GHz (typical) 0.20 $^{\circ}$ / $^{\circ}$ C, 3 GHz to 6 GHz (typical)
Polar characteristics	
Range	$10 \times 10^{-12}$ to 1000 units full scale
Reference	$\pm 500$ units

1. Typical performance.
2. Typical below 300 kHz.
3. The HP 8753E source characteristics and measurement accuracy in this mode are dependent on the stability of the external LO source. The RF source tracks the LO to maintain a stable IF signal at the R channel receiver input. Degradation in accuracy is negligible when using an HP 8642A/B or HP 8656B RF signal generator as the LO source.
4. See the HP 8753E descriptions and options for a functional description. Measurement accuracy is dependent on the stability of the input signal.
5. Marker resolution for magnitude, phase and delay is dependent upon measured value. Resolution is limited to five digits.

## HP 8753E Option 011 specifications

### Test port output characteristics

#### Frequency characteristics

<b>Range</b>	300 kHz to 3 GHz 30 kHz to 6 GHz (with Option 006)
<b>Resolution</b>	1 Hz
<b>Stability</b>	typically $\pm 7.5$ ppm $0^\circ$ to $55^\circ$ C typically $\pm 3$ ppm/year

#### With Option 1D5

typically  $\pm 0.05$  ppm  $0^\circ$  to  $55^\circ$  C  
typically  $\pm 0.5$  ppm/year

<b>Accuracy</b>	$\pm 10$ ppm at $25^\circ$ C $\pm 5^\circ$ C
<b>Power range</b> (with Option 006)	-5 to +20 dBm -5 to +18 dBm

<b>Resolution</b>	0.05 dB
<b>Level accuracy</b> <sup>1,2</sup>	$\pm 1.0$ dB
<b>Level linearity</b> <sup>1,2,5</sup>	(-5 dBm to +15 dBm) $\pm 0.25$ dB (15 dBm to 20 dBm) $\pm 0.5$ dB
<b>Impedance</b>	50 $\Omega$ ; typically $\geq 16$ dB RL (<1.38 SWR) to 3 GHz <sup>2</sup> $\geq 14$ dB RL (<1.50 SWR) to 6 GHz

#### Spectral purity

<b>2nd harmonic</b> <sup>3</sup>	<-25 dBc at 20 dBm <-40 dBc at 10 dBm (typical) <-50 dBc at 0 dBm (typical)
<b>3rd harmonic</b> <sup>4</sup>	<-25 dBc at 20 dBm <-40 dBc at 10 dBm (typical) <-50 dBc at 0 dBm (typical)

#### Nonharmonic spurious

<b>Mixer related</b>	<-30 dBc at 20 dBm (typical) <-55 dBc at 0 dBm (typical)
----------------------	---

### Test port input characteristics

<b>Frequency range</b>	300 kHz to 3 GHz 30 kHz to 6 GHz (with Option 006)
<b>Average noise level</b> <sup>2</sup>	-90 dBm (3 kHz BW, 50 kHz to 3 GHz) -110 dBm (10 Hz BW, 50 kHz to 3 GHz) -120 dBm (10 Hz BW, 50 kHz to 3 GHz) (typical) -85 dBm (3 kHz BW, 3 to 6 GHz) -105 dBm (10 Hz BW, 3 to 6 GHz) -115 dBm (10 Hz BW, 3 to 6 GHz) (typical)

<b>Maximum input level</b>	0 dBm
<b>Damage level</b>	20 dBm or 35 VDC
<b>Impedance: 50 ohms</b>	$\geq 10$ dB RL, 30 kHz to 50 kHz (Option 006 only) <sup>2</sup> $\geq 20$ dB RL, 50 kHz to 300 kHz (Option 006 only) <sup>2</sup> $\geq 23$ dB RL, 300 kHz to 1.3 GHz $\geq 20$ dB RL, 1.3 GHz to 3 GHz $\geq 7$ dB RL, 3 GHz to 6 GHz (Option 006 only) <sup>6</sup>

<b>Frequency response</b> ( $25^\circ + 5^\circ$ C)	$\pm 1.0$ dB, 300 kHz to 3 GHz $\pm 2.0$ dB, 3 GHz to 6 GHz
--	--

#### Harmonics (Option 002)

<b>2nd harmonic</b> <sup>3</sup>	<-15 dBc at 0 dBm <-30 dBc at -10 dBm (typical) <-45 dBc at -30 dBm (typical)
<b>3rd harmonic</b> <sup>4</sup>	<-30 dBc at 0 dBm <-50 dBc at -10 dBm (typical) <-50 dBc at -30 dBm (typical)

<b>Harmonic measurement accuracy</b> ( $25^\circ \pm 5^\circ$ C)	16 MHz to 3 GHz $\pm 1.5$ dB 3 GHz to 6 GHz $\pm 3$ dB (with Option 006)
--	---

#### Harmonic measurement dynamic range

-40 dBc (output = -10 dBm,  
input <-15 dBm)

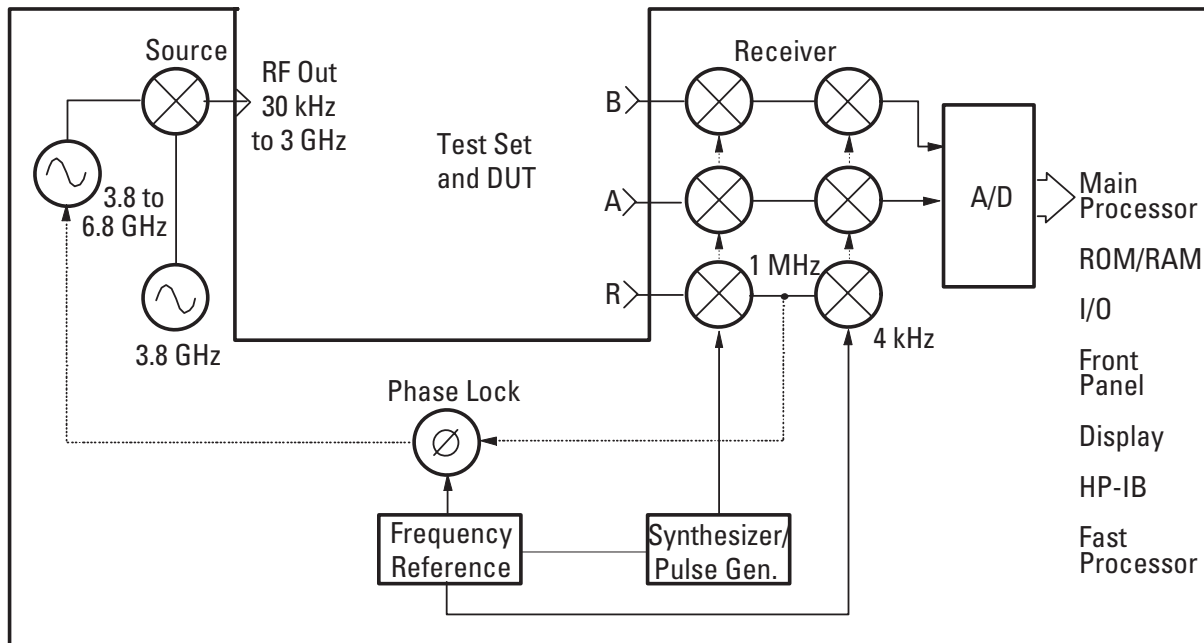

HP 8753E Option 011 block diagram

- At  $25^\circ$  C  $\pm 5^\circ$  C, relative to 0 dBm output power for the HP 8753E, +10 dBm output power for the HP 8753E Option 011.
- Typical below 300 kHz.
- 16 MHz to 3 GHz.
- 16 MHz to 2 GHz.
- For HP 8753D Option 011 and Option 006, linearity is specified for the ranges of (-5 to +13 dBm) and (+13 to +18 dBm).
- Typical

## HP 8753E supplemental characteristics

### Measurement

#### Number of display channels

Two display channels available.

#### Measurement parameters

HP 8753E:  $S_{11}$ ,  $S_{21}$ ,  $S_{12}$ ,  $S_{22}$ , A, B, R, A/R, B/R, A/B.

Conversion to impedance or admittance.

#### Formats

**Cartesian:** log/linear magnitude, phase, group delay, SWR, real and imaginary.

**Smith chart:** with log/linear amplitude and phase,  $R + jX$ ,  $G + jB$ , or real/imaginary markers.

**Polar:** with linear/log amplitude, phase, or real and imaginary markers.

#### Data markers

Each display channel has five independent markers that can be displayed simultaneously. Markers can indicate data at actual data points or they can interpolate between data points to allow the setting of a marker at an exact frequency. Any one of the five markers can be the reference marker for delta marker operation. Markers can be coupled or uncoupled between display channels. Ten independent markers can be displayed simultaneously on a single measurement in dual channel mode when markers are uncoupled.

#### Marker functions

Markers can be used in various functions: Marker search (Mkr to max, Mkr to min, Mkr to target), Mkr bandwidth with user-defined target values, mkr  $\rightarrow$  start, mkr  $\rightarrow$  stop, mkr  $\rightarrow$  center, mkr  $\rightarrow$  span, mkr  $\rightarrow$  reference, mkr  $\rightarrow$  delay, and trace statistics (average value, standard deviation, and peak-to-peak deviation of the data trace between two markers). The tracking function enables continuous update of marker search values on each sweep.

### Group delay characteristics

Group delay is computed by measuring the phase change within a specified frequency step (determined by the frequency span, and the number of points per sweep).

#### Aperture: selectable

Maximum aperture: 20% of frequency span

Minimum aperture: (freq. span) / (number of points - 1)

#### Range

The maximum delay is limited to measuring no more than  $180^\circ$  of phase change within the minimum aperture.

$$\text{Range} = 1 / (2 \times \text{minimum aperture})$$

### Accuracy

The following graph shows group-delay accuracy at 1.3 GHz with type-N full two-port calibration and 10-Hz IF bandwidth. Insertion loss is assumed to be  $< 2$  dB and electrical length to be ten meters.

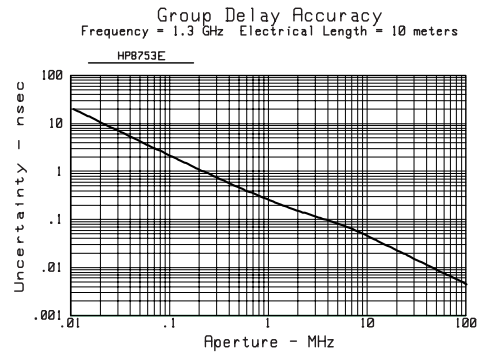

### Source control

#### Sweep limits

Set start/stop or center/span of the stimulus parameter (frequency, power, time) directly through the source control keys and the control knob, the step keys or the data entry keyboard.

#### Sweep type

Set a linear or logarithmic sweep, an arbitrarily defined frequency list, a power sweep or a CW (single frequency) type of sweep.

#### Measured number of points per sweep

Linear frequency: choose 3, 11, 26, 51, 101, 201, 401, 801, or 1601 points.

#### Fast swept list

Define up to 30 different sub-sweep frequency ranges in any combination of CW, CW-delta F, or start-stop sweep modes. Set test-port power levels and IF bandwidth independently for each segment.

#### Sweep modes

Set a coupled channel sweep (same stimulus conditions on both channels) or an uncoupled channel sweep (alternate sweep).

#### Chop/alternate

Select whether to alternately or simultaneously (chop) measure channels when in dual-channel mode. Chop mode is faster, while alternate mode optimizes dynamic range. The analyzers default to chop mode.

## HP 8753E supplemental characteristics, cont'd

### Sweep time

Set sweep time in seconds, minutes or hours. Minimum sweep time is dependent on number of data points per sweep and selected IF bandwidth.

### Automatic sweep time

Select auto sweep time by entering zero seconds sweep time. The analyzer will sweep at the minimum sweep time for any subsequently selected stimulus conditions. Auto sweep time is the default condition.

### Sweep trigger

Set to either continuous, hold, single, group sweep, or external trigger. Set external trigger to take a complete sweep or to measure individual points in a frequency, power or list sweep.

### Power

Set source power ( $-85$  to  $+10$  dBm)<sup>1</sup> for HP 8753E. Power slope can be set in dBm/GHz. Control the test port signal by setting the internal attenuator of the test set over a 70-dB range. Power trip automatically reduces source power to its minimum value when excessive signal levels are incident on the receiver test-port. A caution message is also displayed. (Source power range differs depending on the selected options. Refer to the "Test-Port Output Characteristics" section for the appropriate instrument for more information.)

### Power meter calibration

#### Description

Use a power meter to set leveled input or output power at the device under test at a single point or an entire sweep. With an HP 436A, 437B, 438A, or 441A power meter connected, the Cal Sweep measures the actual test-port power. After the calibration is enabled, the internal RF source power is adjusted (within the range of  $-85$  to  $+10$  dBm) to achieve the selected power at the input of the device under test rather than at the test port output. HP-IB control of the power meter for normalization or leveling is built-in. Logarithmic, linear, CW, and list sweeps can be calibrated.

#### Update calibration

Select continuous leveling (requires a power splitter) by measuring and updating source power on each sweep or use a correction table (to modify source power), which is created with an initial single sweep.

#### Number of readings

Make single or multiple power meter readings at each frequency.

### Data accuracy enhancement

#### Measurement calibration

Measurement calibration is the process through which measurement uncertainty due to errors caused by system directivity, source and load match, tracking, and crosstalk are significantly reduced. A wide range of calibrations are available for the HP 8753E. Full two-port calibration removes all the systematic errors to obtain the most accurate measurements.

#### Calibration types available

- **Frequency response**

Simultaneous magnitude and phase correction of frequency response errors for either reflection or transmission measurements. Requires a short or open circuit termination (reflection) or a through connection (transmission).

- **Response and isolation**

Compensates for frequency response and directivity (reflection) or frequency response and crosstalk errors. Requires an open, short, and load circuit termination (reflection) and a through connection and load termination (transmission).

- **One-port calibration**

Uses test set port 1 or port 2 to correct for directivity, frequency response and source match errors. Requires open, short, and load.

- **Two-port calibration**

Compensates for directivity, source match, reflection frequency response, load match, transmission frequency response and crosstalk for an S-parameter test set. Crosstalk calibration can be eliminated. Requires open, short, and load terminations for both ports plus a through connection.

- **TRL\*/LRM\* calibration**

Compensates for directivity, reflection and transmission frequency response, and crosstalk in both the forward and reverse directions. Especially suitable for calibrating non-coaxial environments, such as in test fixtures. Requires through, reflect, and line or match standards. TRL\*/LRM\* is a special implementation of TRL/LRM calibration, modified for the three-sampler receiver in the HP 8753E.

- **One-port, two-path calibration**

A two-port cal for the one-port reflection/transmission test sets. Provides a full two-port error corrected measurement when the device under test is turned around and measured in both directions.

1.  $+8$  dBm with Option 075.

## HP 8753E supplemental characteristics, cont'd

- **Interpolated error correction**

With any type of accuracy enhancement applied, interpolated mode recalculates the error coefficients when the test frequencies are changed. The number of points can be increased or decreased and the start/stop frequencies can be changed, but the resulting frequency span must be equal to or less than the original calibration frequency span. System performance is not specified for measurements with interpolated error correction applied.

- **Set  $Z_0$**

Can redefine the characteristic impedance of a measurement to a value other than 50 or 75-ohms.

- **Velocity factor**

Enters the velocity factor to calculate equivalent electrical length.

- **Reference plane extension**

Redefine the plane of measurement reference to other than port 1 or port 2 of the HP 8753E. A new reference plane is defined in seconds of delay from the test set port and ranges between  $\pm 1$  second.

- **Select default calibration kit**

Select from a list of standard calibration kits: 7 mm, 3.5 mm (choose HP 85033C or 85033D), type-N 50 ohm, and type-N 75 ohm. You can also define the standards (for example open circuit capacitance coefficients, offset short length, or fixed loads) of a user-defined kit.

- **Data averaging**

***IF bandwidth:***

The IF bandwidth is selectable from 6 kHz to 10 Hz bandwidth to reduce the effective displayed noise floor of the instrument.

***Weighted sweep-to-sweep averaging:***

Averages vector data on each successive sweep.  $A(n) = S(n)/F + (1-1/F)*A(N-1)$  where  $A(n)$  is the current average,  $S(n)$  is the current input signal and  $F$  is the averaging factor. Averaging factors range from 1 to 999.

- **Trace smoothing**

Similar to video filtering, this function computes the moving average of adjacent data points. Advantageous in reducing relatively small peak-to-peak noise values on large broadband measured data. Smoothing aperture defines the trace width (number of points) to be averaged, and ranges from 0.25% to 20% of the trace width. This function also sets the aperture for group delay measurements.

### Display Control

#### LCD formats

Single-channel, dual-channel overlay (both traces on one graticule), dual-channel split (each trace on separate graticules).

#### Trace functions

- **Display data**

Display current measurement data, memory data, or current measurement with measurement and memory data simultaneously.

- **Trace math**

Vector division or subtraction of current linear measurement values and memory data.

#### Display annotations

Start/stop, center/span, or CW frequency, source level, scale/div, reference level, marker data, soft key functions, warning and caution messages, trace identification, and pass/fail indication.

#### Reference position

Ranges from the 0 (bottom) to 10 (top) graticule position.

#### Autoscale

Automatically selects scale resolution and reference value to center the trace on the CRT graticules for easy viewing.

#### Electrical delay

Offset measured phase or group delay by a defined amount of electrical delay, in seconds. Operates similarly to an electronic line stretcher. Amount of electrical delay can range between  $\pm 1$  second.

#### Frequency blanking

Blank out all frequency information on the display. Requires an instrument preset to re-enable frequency information on the display.

#### Title

Add custom titles (49 characters maximum) to the display of the HP 8753E. Titles will be plotted when making hard copies of displayed measurements. Titles can also be used to display operator messages or prompts for a manual adjustment during a test sequence.

#### Adjust display

Control the intensity and background intensity values of the display. Also, customize the color, value, and brightness of the data traces, memory traces, reference lines, graticules, text, and warning messages. Default colors can be recalled along with one set of user-defined display values. Control is in % of full range.

## HP 8753E supplemental characteristics, cont'd

### Storage

#### Instrument state

Up to 31 instrument states can be stored internally or recalled via the SAVE/RECALL menu. Instrument states include all control settings, active limit lines, active list frequency tables, memory trace data, active calibration coefficients, and custom display titles. Storage is in nonvolatile memory.

#### Test sequences

Six measurement sequences can be stored or recalled via the sequencing menu. Sequences may also be recalled from Preset menu. Sequence register 6 is part of non-volatile storage and is not erased during a power cycle. If sequence 6 is titled AUTO, it will be executed when power is turned on.

#### Disk drive

Data, instrument states (including calibration data), user graphics, data plots (HP-GL commands), and test sequences can also be stored on disk, using the HP 8753E's built-in disk drive or an external disk drive with command subset CS/80. Data files can be stored in MS-DOS format or Hewlett-Packard's standard LIF format, which can be read by a wide variety of computers, including the HP 9000 series 300 and 400. Files can be stored in binary, ASCII formats or Touchstone<sup>®</sup> format (S2P). A disk to be used for data storage can be initialized directly by the HP 8753E.

### Data hardcopy

#### Data plotting

Hard copy plots are automatically produced with HP-GL compatible digital plotters such as the HP 7475A and compatible graphics printers such as the HP DeskJet or LaserJet (in single color or multi-color format). The HP 8753E provides Centronics, RS-232C, and HP-IB interfaces.

#### Data listings

Printouts of instrument data are directly produced with a printer such as the HP DeskJet or LaserJet. Select a standard (single color) or color print (with color printers). For a list of compatible printers, consult our printer-compatibility guide Web page. Its URL address is <http://www.hp.com/go/pcg>

#### Configure plots

Configure plots completely from the network analyzer by defining pen color and line type for data, text markers, graticules, and memory traces.

### Functions

Plot trace(s), graticule(s), marker(s), or text including operating and system parameters.

#### Quadrants

Plot entire display in one of four different quadrants of the plotter paper.

### System capabilities

#### Limit lines

Define test limit lines that appear on the display for go/no go testing. Lines may be any combination of horizontal, sloping lines, or discrete data points. Limit-test TTL output available for external control or indication.

#### Operating parameters

Display, print or plot current instrument operating parameters.

#### Transform

When time domain (Option 010) is present, selects the Time Domain transform menu.

#### Harmonic measurements

When harmonic measurement (Option 002) is present, selects the 2nd or 3rd harmonic measurement menu.

#### Instrument mode

Select external source, tuned receiver or frequency offset mode.

#### External source mode

The receiver (input R) detects and phase-locks to any externally generated CW signal. Receiver inputs A and B will measure this same frequency for comparison or tracking measurements.

- **Automatic**

The input signal frequency is counted and displayed.

- **Manual**

Measures the input signal closest to the frequency specified by the user (within  $-0.5$  to  $+5$  MHz).

#### Tuned receiver

Tunes the receiver for a synthesized CW input signal at a precisely specified frequency. The time bases of the external RF source or sources must be tied to the external reference input (rear panel BNC). The built-in RF source is not used.

#### Frequency offset on/off

Sets the RF source to be swept at a fixed offset frequency above the receiver as required in a swept RF/IF, fixed LO, mixer test. The maximum delay between the RF source and the R channel input is 0.3 microseconds. Frequency offset mode has a 6 GHz maximum source limitation.

## HP 8753E supplemental characteristics, cont'd

### Offset value

Set the offset frequency value.

### Service menu

Select the desired service test, service diagnostic, service or verification mode.

### Test sequences

#### Description

Create, edit, save or recall a series of front-panel key-strokes to automate a measurement. Each of the six sequence registers can hold approximately 200 instructions. Create or edit a sequence by selecting the sequence menu and then simply performing the front-panel key-strokes that would normally be used to make a manual measurement. Test sequences may contain basic stimulus and measurement functions (frequency, power, parameter, format, scale) advanced operations (time domain, limit testing, display marker values) and basic logical branching (IF limit test fails DO sequence 5). Completed sequences are then saved and can be executed when you are ready to repeat the test.

#### Storage

Test sequences can be stored internally to a disk drive and can be loaded from a computer over the HP-IB interface. Sequence 6 is saved in nonvolatile storage and can be used as an autostart routine when titled AUTO.

#### Branching

Branch to another sequence on limit test pass/fail, or the loop counter value. Subroutines are also possible via GOSUB.

#### Other HP-IB instruments

Send simple commands to HP-IB instruments via the title string.

#### Test sequence BNC output

Set TTL high or low on the rear panel output.

#### General purpose input/output

Read or write bits to the output port to control external devices such as part handlers. Eight output and five input TTL lines are available on the parallel port of the HP 8753E.

#### Other functions

PAUSE/continue, wait, title sequence, print sequence, duplicate sequence, pause and select. Time Domain (Option 010)

### Time domain (Option 010)

#### Description

With the time domain option, data from transmission or reflection measurements in the frequency domain is converted to the time domain using a Fourier transformation technique (Chirp Z) and presented on the display. The time domain response shows the measured parameter value versus time. Markers may also be displayed in electrical length (or physical length if the relative propagation velocity is entered).

#### Time stimulus modes

- **Standard stimulus**

Two types of time excitation stimulus waveforms can be simulated during the transformation — a step and an impulse.

- **External stimulus**

The definition of other time excitation stimulus waveforms can be accomplished using an external controller.

- **Low pass step**

This stimulus, similar to a traditional time domain reflectometer (TDR) stimulus waveform, is used to measure low pass devices. The frequency domain data should extend from DC (extrapolated value) to a higher value, the upper limit being defined by the test set used. The time domain response shows the parameter value versus time (multiply by the speed of light,  $c$ , to obtain electrical length or by  $c$  and  $V_{rel}$  to obtain physical length). The step response is typically used for reflection measurements only.

- **Low pass impulse**

This stimulus is also used to measure low pass devices. The frequency domain data should extend from DC (extrapolated value) to a higher value, the maximum frequency determined by the test set. The time domain response shows changes in the parameter value versus time. The impulse response can be used for reflection or transmission measurements.

- **Bandpass impulse**

The bandpass impulse stimulates a pulsed RF signal (with an impulse envelope) and is used to measure the time domain response of band-limited devices. The start and stop frequencies are selectable by the user to any values within the limits of the test set used. The bandpass time domain response also shows changes in the parameter values versus time. Bandpass time domain responses are useful for both reflection and transmission measurements.

## HP 8753E supplemental characteristics, cont'd

- **Time domain range**

The range over which the display is free of response repetition depends on the frequency span and the number of points. Range, in nanoseconds, is determined by

$$\text{Range} = 1/\Delta F = \frac{(\text{Number of points in Frequency Domain} - 1)}{\text{Frequency Span (GHz)}}$$

- **Range resolution**

Range-resolution is how closely in time that a response can be located.

$$\text{Range-resolution} = \text{time span}/(\text{number of points} - 1)$$

- **Windows**

The windowing function can be used to modify (filter) the frequency domain data and thereby reduce overshoot and ringing in the time domain response. Three types of windows are available — minimum, normal, and maximum.

- **Gating**

The gating function can be used to selectively remove reflection or transmission time domain responses. In converting back to the frequency domain the effects of the responses outside the gate are removed. The location and span of the gate can be controlled by setting either the center position and time span of the gate or by setting the start and stop time of the gate.

## HP 8753E Options

### Harmonic measurements (Option 002)

#### Description

Measures amplifier 2nd and 3rd harmonics on a swept-frequency basis for fundamental signals above 16 MHz. Harmonics are measured up to the maximum frequency range of the receiver. The second harmonic of a 1 GHz fundamental can be measured and displayed. If Option 006 is installed, the 2nd harmonic of a 3 GHz fundamental and 3rd harmonic of a 2 GHz fundamental can be measured.

**Dynamic range** (source at -10 dBm, receiver <-30 dBm): -40 dBc (minimum)

**Accuracy:** <sup>1</sup> ±1 dB (< 6 GHz)

### 6 GHz operation (Option 006)

#### Description

With the 6 GHz option, performance is specified over the 30 kHz to 6 GHz range. When external source, tuned receiver or harmonic mode is used, the receiver is capable of measuring signals up to 6 GHz.

### High-stability frequency reference (Option 1D5)

#### Description

This option adds an ovenized 10-MHz frequency reference output to the HP 8753E. It is connected to the external reference input on the rear panel. See the "General Characteristics" section for specifications.

### Measurement throughput summary

The following table shows typical measurement times in milliseconds.

#### Typical time for completion (msec)

	Number of Points			
	51	201	401	1,601
<b>Measurement</b>				
Uncorrected, 1-port calibration <sup>2</sup>	40	77	127	428
Two-port calibration <sup>3</sup>	70	145	244	845
<b>Time domain conversion<sup>4</sup></b>	14	46	91	392
<b>HP-IB data transfer<sup>5</sup></b>				
Internal binary	6	11	17	52
ASCII	40	147	289	1142
IEEE 754 floating point format:				
32-bit	8	15	25	79
64-bit	9	22	40	137

## Remote programming

### Interface

HP-IB interface operates to IEEE 488-1978 and IEC 625 standards and IEEE 728-1982 recommended practices.

### Addressing

The HP-IB address of the HP 8753E can be verified or set from the front panel via the local menu and can range from 0 to 30 decimal (factory set at 16).

### Pass control

Allows the HP 8753E to request control of the HP-IB (when an active controller is present) whenever it needs to output to a plotter or printer.

### System controller

Lets an HP 8753E become a controller on the HP-IB to directly control a plotter or a printer.

### Talker/listener

Lets the HP 8753E become an HP-IB talker/listener when an external controller is present.

---

1. Does not include error from the HP 8753D source and receiver harmonics.  
 2. One-port calibration, with a 6 kHz IF bandwidth. Includes system retrace time, but does not include bandwidth time. Time domain gating is assumed off.  
 3. Same as footnote 2, but for an S21 measurement with full two-port calibration. Includes RF switching time.  
 4. Option 010 only, gating off.  
 5. Measured with an HP omnibook 5500 133 pentium computer.



## HP 8753E supplemental characteristics, cont'd

### Transfer formats

Binary (internal 48-bit floating point complex format)  
ASCII 32- or 64-bit IEEE 754 floating point format

### User-accessible graphics

Using a subset of HP graphics language (HP-GL), vector or text graphics may be written on the HP 8753E via HP-IB. Up to 5 kbytes of data can be stored at one time (4 bytes per vector, 2 bytes per character).

### Interface function codes

SH1, AH1, T6, TE0, L4, LE0, SR1, RL1, PP0, DC1, DT0, C1, C2, C3, C10, E2

## General characteristics

### Front panel connectors

#### HP 8753E test ports (without Option 011)

Connector type	7 mm, precision
Impedance	50 ohms (nominal)
Connector conductor depth	0.000 to 0.003 in.

#### Option 011 test ports

Connector type	Type-N
Impedance	50 ohms (nominal)
Connector center pin protrusion	0.204 to 0.207 in.

#### Option 075 test ports

Connector type	Type-N
Impedance	75 ohms (nominal)
Connector center pin protrusion	0.204 to 0.207 in.

### Probe power

+15V  $\pm$ 2% 400 mA (combined load for both probe connections)  
-12.6V  $\pm$ 5.5% 300 mA (combined load for both probe connections)

### Rear panel connectors

#### External reference frequency input (EXT REF INPUT)

Frequency	1, 2, 5, and 10 MHz ( $\pm$ 200 Hz at 10 MHz)
Level	-10 dBm to +20 dBm, typical
Impedance	50 ohms
Connector	BNC (f)

#### High-stability frequency reference output (Option 1D5)

Frequency	10.0000 MHz
Frequency stability (0° C to 55° C)	$\pm$ 0.05 ppm
Daily aging rate (after 30 days)	$<3 \times 10^{-9}$ /day
Yearly aging rate	0.5 ppm/year
Output	0 dBm minimum
Nominal output impedance	50 $\Omega$
Connector	BNC (f)

#### External auxiliary input (AUX INPUT)

Input voltage limits	-10V to +10V
----------------------	--------------

**External AM input (EXT AM)**  $\pm$ 1 volt into a 5 k  $\Omega$  resistor, 1 kHz maximum, resulting in 8 dB/volt amplitude modulation. BNC (f) connector.

**External trigger(EXT TRIGGER)** Triggers on a negative TTL transition or contact closure to ground. BNC (f) connector.

### Test sequence output (TEST SEQ)

By default, this connector outputs a TTL end-of-sweep signal. It can also be programmed by the user in a test sequence to output a user-defined TTL signal. BNC (f) connector.

### Limit test output (LIMIT TEST)

This connector outputs a TTL signal of the limit test results. Pass: TTL high. Fail: TTL low. BNC (f) connector.

### Test-port bias input (BIAS CONNECT)

Maximum voltage	+30 VDC
Maximum current (no degradation in RF specs)	$\pm$ 200 mA
Maximum current	$\pm$ 1 A
Connector	BNC (f)

### VGA video output (EXT MON)

This connector drives external VGA monitors.

### HP-IB

This connector allows communications with compatible devices including external controllers, printers, plotters, disk drives, and power meters.

### Parallel port

This 25-pin female connector is used with parallel (or Centronics interface) peripherals such as printers and plotters. It can also be used as a general purpose I/O port, with control provided by test sequencing functions.

### RS-232C

This 9-pin male connector is used with serial peripherals such as printers and plotters.

### DIN keyboard

This connector is used for adding an IBM PC-AT compatible keyboard for titles and remote front-panel operation.

### Test set interconnect

This connector is used to connect an HP 8753E Option 011 to the HP 85046A/B or 85047A test set. On other HP 8753E analyzers, you can use signal levels on this connector for sequencing or general purpose I/O applications.

## HP 8753E supplemental characteristics, cont'd

### Internal memory

Typical data retention time with 3V, 1.2 Ah battery:  
 At 25° C 11904 days (32.6 years)  
 At 40° C 1244 days (3.4 years)  
 At 70° C 250 days (0.68 year)

### Line power

48 Hz to 66 Hz  
 115V nominal (90V to 132V) or 230V nominal (198V to 264V).  
 280 VA max.

### Weight HP 8753E

**Net** 21 kg (46 lb)  
**Shipping** 35 kg (77 lb)

### Cabinet dimensions

(These dimensions exclude front and rear panel protrusions.)

### HP 8753E

222 mm H x 425 mm W x 457 mm D  
 (8.75 in x 16.75 in x 18.0 in)

## Environmental characteristics

### General conditions

RFI and EMI susceptibility: defined by VDE 0730, CISPR Publication 11, and FCC Class B Standards.

ESD (electrostatic discharge): must be eliminated by use of static-safe work procedures and an anti-static bench mat. The flexible rubber keypad protects key contacts from dust, but the environment should be as dust-free as possible for optimal reliability.

### Operating conditions

#### Temperature

(unless otherwise noted)

0° to 55° C

#### Humidity

5% to 95% at 40° C  
 (non-condensing)

#### Altitude

0 to 4500 meters  
 (15,000 feet)

### Non-operating storage conditions

#### Temperature

-40° C to +70° C

#### Humidity

0 to 90% relative at  
 +65° C (non-condensing)

#### Altitude

0 to 15,240 meters  
 (50,000 feet)

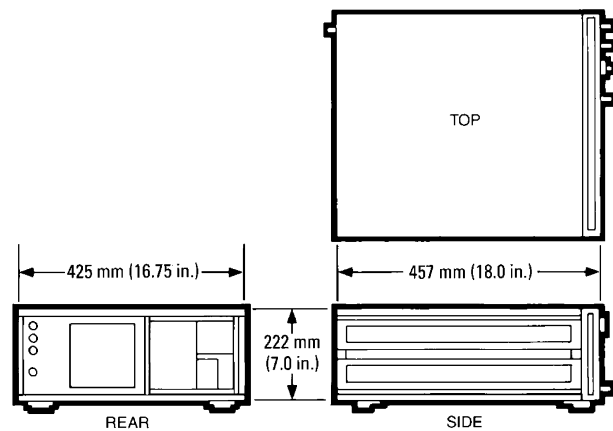

HP 8753E physical dimensions

## HP 8753E test set specifications

### HP 85046A/B S-parameter test sets

The HP 85046A/B S-parameter test sets provide the capability to measure reflection and transmission characteristics (including S-parameters) of two-port devices in either direction with a single connection. The test sets are controlled from the HP 8753E Option 011 and include a programmable step attenuator. The frequency range of the HP 85046A 50-ohm test set is 300 kHz to 3 GHz. The HP 85046A has precision 7-mm connectors. The frequency range of the HP 85046B 75-ohm test set is 300 kHz to 2 GHz. The HP 85046B has 75-ohm type-N(f) connectors. Both connectors can be adapted to other interfaces with the appropriate precision adapters.

#### Specifications HP 85046A(B)

<b>Impedance</b>	50 ohm (75 ohm)
<b>Frequency range</b>	300 kHz to 3 GHz (300 kHz to 2 GHz)
<b>Directivity</b>	35 dB to 1.3 GHz 30 dB to $F_{\max}^1$

#### Typical tracking

##### Transmission magnitude, phase<sup>2</sup>

0.3 MHz to 2.0 MHz  $\pm 1.5$  dB,  $\pm 20^\circ$

2.0 MHz to  $F_{\max}$   $\pm 1.5$  dB,  $\pm 10^\circ$

##### Reflection magnitude, phase<sup>2</sup>

0.3 MHz to 2.0 MHz  $\pm 1.5$  dB,  $\pm 25^\circ$

2.0 MHz to  $F_{\max}$   $\pm 1.5$  dB,  $\pm 10^\circ$

##### Effective source match

0.3 MHz to 2.0 MHz 14 dB

2.0 MHz to 1.3 GHz 20 dB (17 dB)

1.3 GHz to  $F_{\max}$  16 dB

#### Nominal insertion loss

**Input to test port** 14 dB + 0.5 dB/GHz  
(19.5 dB + 1 dB/GHz)

**Input to incident** 18 dB + 1.5 dB/GHz  
(18 dB + 1.5 dB/GHz)

**Port 1, 2 to A, B** 6.5 dB + 1.0 dB/GHz  
(12 dB + 0.5 dB GHz)

#### Test set switch/repeatability<sup>3</sup>

$\pm 0.03$  dB

#### Max. operating level

+20 dBm

#### Damage level

+30 dBm

#### RF attenuator range

70 dB (10 dB steps)

#### DC bias range

$\pm 30$  VDC, 200 mA (some degradation of RF specs)  
500 mA max

#### DC bias connectors

50 ohm BNC (f)

##### Includes

four 190 mm (7.5 in) type-N cables and test set interconnect cable.

#### Dimensions

90 mm H x 432 mm W x 553 mm D

#### Weight

9.1 kg (20 lb)

A standard HP 85046A/B test set contains a solid-state transfer switch, which allows continuous switching of power from port 1 to port 2 for full two-port error correction. Option 009 replaces the transfer switch with a mechanical switch. This provides about 1.5 dB more power at the test port, but does not allow continuous switching, so the user must initiate updates of all four S-parameters for full two-port error correction. Also, the mechanical switch has relays that will wear out faster than the solid-state switch. Approximate lifetime of the mechanical switch is 1 million cycles.

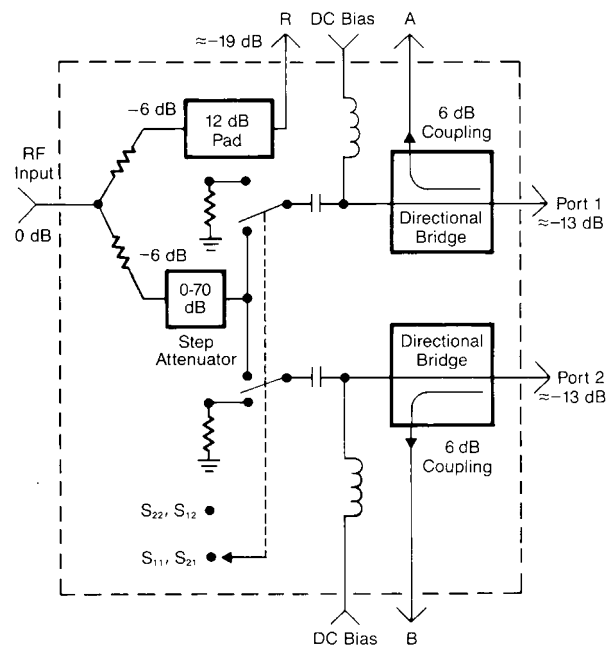

HP 85046A schematic

1.  $F_{\max}$  is the upper frequency limit of the associated test set.  
2. Degrees, specified as deviation from linear phase.  
3. Typical repeatability is  $\pm 0.01$  dB.

## HP 8753E test set specifications, cont'd

### HP 85047A S-parameter test set

The HP 85047A S-parameter test set provides the capability to simultaneously measure the reflection and transmission characteristics of two-port devices in either direction with a single connection. This test set includes a frequency doubler that can be switched in by an HP 8753B/C Option 006 to measure 3 MHz to 6 GHz in a single sweep or switched out to measure 300 kHz to 3 GHz in a single sweep. The HP 8753E Option 011 does not use the frequency doubler, so the full 300 kHz to 6 GHz range is available. This test set exhibits <math><5\text{ dB}</math> insertion loss between the RF input and the test ports for as high as 15 dBm at the test port, and also includes a programmable step attenuator. There are two rear panel BNC outputs. One provides a TTL signal which indicates the result of a limit test. The second TTL output is controlled from the HP 8753E test sequence function.

Specifications	HP 85047A
<b>Impedance</b>	50 ohms
<b>Frequency range</b>	300 kHz to 3 GHz and 3 GHz to 6 GHz with HP 8753B/C; 300 kHz to 6 GHz (HP 8753E Opt. 006)
<b>Directivity<sup>1</sup></b>	
300 kHz to 1.3 GHz	35 dB <sup>2</sup>
1.3 GHz to 3 GHz	30 dB
3 GHz to 6 GHz	25 dB
<b>Typical tracking<sup>1</sup></b>	
<b>Transmission magnitude, phase<sup>3</sup></b>	
300 kHz to 3 GHz	$\pm 1.5\text{ dB}, \pm 10^\circ$
3 GHz to 6 GHz	$+0.5, -2.5\text{ dB}, \pm 20^\circ$
<b>Reflection magnitude, phase<sup>3</sup></b>	
300 kHz to 3 GHz	$\pm 1.5\text{ dB}, \pm 10^\circ$
3 GHz to 6 GHz	$\pm 1.5\text{ dB}, \pm 20^\circ$
<b>Source match<sup>1</sup></b>	
300 kHz to 1.3 GHz	20 dB
1.3 GHz to 3 GHz	16 dB
3 GHz to 6 GHz	14 dB
<b>Normal insertion loss</b>	
<b>Input to port 1,2</b>	4.0 dB +0.8 dB/GHz (3 GHz range) 17.5 dB +0.8 dB/GHz (6 GHz range)
<b>Input to R</b>	19 dB +0.5 dB/GHz (3 GHz range) 34 dB +0.5 dB/GHz (3 GHz range)
<b>Port 1,2 to A,B</b>	16 dB
<b>Typical isolation</b>	100 dB (3 GHz range) 90 dB (6 GHz range)
<b>Test port switch repeatability<sup>4</sup></b>	$\pm 0.03\text{ dB}$
<b>Maximum operating level</b>	+20 dBm
<b>Damage level</b>	+30 dBm
<b>RF attenuator range</b>	70 dB (10 dB steps)
<b>DC bias range</b>	$\pm 30\text{ VDC}, 200\text{ mA}$ , no degradation in RF specs, 1A max.

#### RF connectors

**Port 1,2**

7 mm precision

**All others**

50 ohm type N(f)

**Dimensions**

90 mm H x 432 mm W x 553 mm D

**Weight**

10 kg (22 lb)

A standard HP 85047A test set contains a solid-state transfer switch, which allows continuous switching of power from port 1 to port 2 for full two-port error correction. Option 009 replaces the transfer switch with a mechanical switch. This provides about 2.5 to 3.5 dB more power at the test port, but does not allow continuous switching, so the user must initiate updates of all four s-parameters for full two-port error correction. Also, the mechanical switch has relays that will wear out faster than the solid-state switch. Approximate lifetime of the mechanical switch is 1 million cycles.

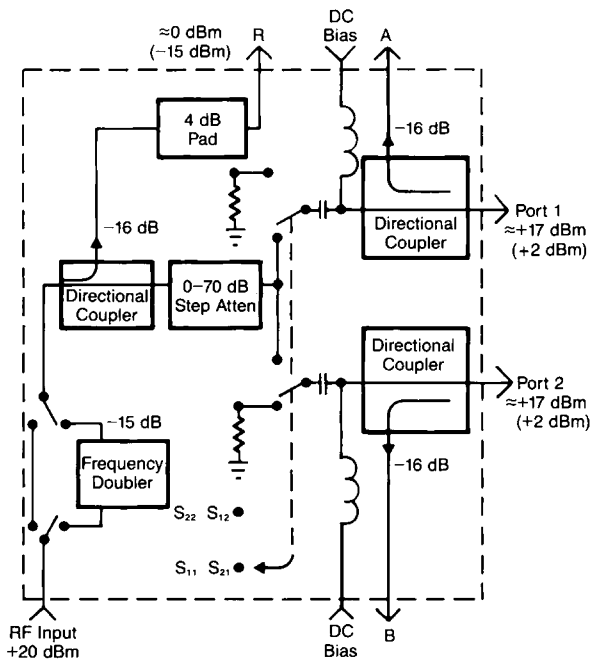

HP 85047A Schematic

1. These can be greatly improved with accuracy enhancement.
2. Some degradation at environmental extremes below 600 kHz.
3. Degrees, specified as deviation from linear phase
4. Typical repeatability is  $\pm 0.01\text{ dB}$ .

## HP 8753E accessories

### Calibration kits

Vector accuracy enhancement procedures require that the systematic errors of the measurement system be characterized by measuring known devices (standards) on the system over the frequency range of interest. The following calibration kits contain precision standards in many different connector types. Return loss specifications or typical values are provided where available for the terminations and adapters.

#### HP 85031B 7-mm calibration kit

Contains precision 7-mm standards used to calibrate the HP 8753E for measurement of devices with precision 7 mm connectors.

<b>Includes</b>	<b>HP part number</b>
7 mm short/open circuit	85031-60001
7 mm 50-ohm term (two each)	00909-60008
Specifications for terminations	DC to 5 GHz: $RL \geq 52$ dB 5 to 6 GHz: $RL \geq 46$ dB

#### HP 85032B 50-ohm type-N calibration kit

Contains precision 50-ohm type-N standards used to calibrate the HP 8753E and 50-ohm test sets for measurement of devices with 50-ohm type-N connectors. Precision phase-matched 7-mm to type-N adapters are included for accurate measurements of non-insertable devices.

<b>Includes</b>	<b>HP part number</b>
N-male 50-ohm termination	00909-60009
N-female 50-ohm termination	00909-60010
N-male short circuit	85032-60008
N-female short circuit	85032-60009
N-female open circuit	85032-60012
N-male open circuit	85032-60007
7 mm to N-male adapter (two each)	85054-60009
7 mm to N-female adapter (two each)	85054-60001
Specifications for terminations	DC to 3 GHz: $RL \geq 49$ dB 2 to 3 GHz: $RL \geq 46$ dB 3 to 6 GHz: $RL \geq 40$ dB
Typical adapter characteristics	DC to 6 GHz: $RL \geq 30$ dB

#### HP 85033D 3.5-mm calibration kit

Contains a set of precision 3.5-mm standards to calibrate the HP 8753E and 50-ohm test sets for the measurement of devices with precision 3.5-mm and SMA connectors. Precision phase-matched 7-mm to 3.5-mm adapters are included for accurate measurements of non-insertable devices.

<b>Includes</b>	<b>HP part number</b>
3.5-mm-male 50-ohm termination	85033-60009
3.5-mm-female 50-ohm termination	85033-60010
3.5-mm-female short	85033-60014
3.5-mm-male short	85033-60013
3.5-mm-female open	85033-60012
3.5-mm-male open	85033-60011
7-mm to 3.5-mm female adapter (two)	1250-1747
7-mm to 3.5-mm male adapter (two)	1250-1746
Specifications for terminations	DC to 1.3 GHz: $RL \geq 46$ dB 1.3 to 3 GHz: $RL \geq 44$ dB 3 to 6 GHz: $RL \geq 38$ dB
Typical adapter characteristics	DC to 6 GHz: $RL \geq 34$ dB

#### HP 85036B 75-ohm type-N calibration kit

Contains a set of precision 75-ohm type-N standards to calibrate the HP 8753E and 75-ohm test sets for measurement of devices with 75-ohm type-N connectors. Precision phased matched adapters are included for accurate measurements of non-insertable devices.

<b>Includes</b>	<b>HP part number</b>
N-male 75-ohm termination	00909-60019
N-female 75-ohm termination	00909-60020
N-female 75-ohm short	85036-60011
N-male 75-ohm short	85036-60012
N-female open	85032-20001
N-male open	85032-60007
N-male to N-male 75-ohm adapter	85036-60013
N-female to N-female 75-ohm adapter	85036-60014
N-male to N-female 75-ohm adapter	85036-60015
Specifications for terminations	DC to 2 GHz: $RL \geq 46$ dB 2 to 3 GHz: $RL \geq 40$ dB

## HP 8753E accessories, cont'd

### HP 85039B type-F calibration kit

Contains a set of 75-ohm type-F standards to calibrate the HP 8753E and 75-ohm test set for the measurement of devices with type-F connectors.

Includes	HP part number		
F-male 75-ohm termination	85039-60007		
F-female 75-ohm termination	85039-60004		
Specifications for termination	DC to 1 GHz:	RL ≥ 45 dB	
	1 to 3 GHz:	RL ≥ 38 dB	
F-male 75-ohm short	85039-60008		
F-female 75-ohm short	85039-60003		
F-male 75-ohm open	85039-60009		
F-female 75-ohm open	85039-60005		
F-female to F-female 75-ohm adapter	85039-60002		
F-male to F-male 75-ohm adapter	85039-60006		
Typical type-F adapter characteristics	DC to 1 GHz:	RL ≥ 40 dB	
	1 to 3 GHz:	RL ≥ 32 dB	
F-female to N-male 75-ohm adapter	85039-60013		
F-male to N-female 75-ohm adapter	85039-60011		
Typical type-F to type-N adapter characteristics	DC to 1 GHz:	RL ≥ 38 dB	
	1 to 3 GHz:	RL ≥ 32 dB	

### Verification kits

Measuring known devices other than the standards used in calibration is an easy way to verify the proper operation of an HP 8753E measurement system. HP offers verification kits which include devices, with data, for verifying the error-corrected measurements of an HP 8753E and 50-ohm test sets.

### HP 85029B 7-mm verification kit

Contains a set of precision 7-mm devices, with data traceable to NIST\* used to compare the calibrated performance of an HP 8753E measurement system. The HP 85031B 7-mm calibration kit is required for complete verification.

### Test-port return cables

Hewlett-Packard offers high quality RF cables used to connect the HP 8753E and test sets to devices under test. These cables offer excellent RF shielding for high dynamic range measurements.

### HP 11851B 50-ohm type-N RF cable kit

Recommended for use with the HP 11850C/D three way power splitters. Kit includes three phase-matched 610-mm (24 in) cables and one 860-mm (34 in) cable.

Return loss	> 24 dB to 3 GHz
Phase tracking	± 4° at 1.3 GHz

### HP 11857B 75-ohm type-N test port return cables

A pair of 610-mm (24 in) test port return cables for use with the HP 8753E or HP 85046B 75-ohm S-parameter test set.

Return loss	> 24 dB to 2 GHz
Phase tracking	± 2° at 1.3 GHz

### HP 11857D 7-mm test-port return cables

A pair of 610-mm (24 in) test port return cables for use with the HP 8753E or HP 85046A, HP 85047A S-parameter test sets. These cables can be used with connector types other than 7-mm with the appropriate precision adapters.

Return loss	>24 dB to 3 GHz
	>20 dB to 6 GHz
Phase tracking	± 2° at 1.3 GHz

### HP 11850C/D three-way power splitters

	HP 11850C	HP 11850D
<b>Impedance</b>	50 ohms	75 ohms
<b>Frequency range</b>	DC to 3 GHz	DC to 2 GHz
<b>Tracking</b>	±25 dB, ±3°	±2 dB, ±2.5°
<b>Equivalent source match</b>	30 dB at 1.3 GHz	30 dB at 1.3 GHz
(ratio or leveling)	20 dB at 3 GHz	20 dB at 2 GHz
<b>Nominal insertion loss</b>	9.5 dB + 1 dB/GHz	7.8 dB
<b>Input port match</b>		
DC to 1.3 GHz	20 dB	20 dB
1.3 GHz to Fmax	10 dB	10 dB
<b>Maximum operating level</b>	+20 dB	+20 dB
<b>Damage level</b>	+30 dB	+30 dB
<b>RF connectors</b>		
RF input	50 ohm type-N (f)	50 ohm type-N(f)
All others	50 ohm type-N (f)	75 ohm type-N(f)
<b>Includes</b>		3 each HP 11852B 50 to 75 ohm minimum loss pads
<b>Recommended accessories</b>	HP 11851B RF cable kit	

### HP 11667A 50-ohm power splitter

<b>Frequency range</b>	DC to 18 GHz
<b>Typical insertion loss</b>	6 dB
<b>Equivalent source match</b>	26 dB to 4 GHz
	21 dB to 8 GHz
	17 dB to 18 GHz
<b>Tracking</b>	± 15 dB to 4 GHz
(between output arms)	± 2 dB to 8 GHz
	± 25 dB to 18 GHz
<b>Maximum operating level</b>	± 27 dBm
<b>Connectors</b>	50 ohm type-N (f)

1. National Institute of Standards and Technology.

## HP 8753E accessories, cont'd

Opt 001	type-N (m) on RF input type-N (f) on outputs
Opt 002	type-N (f) on RF input precision 7-mm on outputs
<b>Dimensions</b>	46 mm H x 52 mm W x 19 mm D (1.8 x 2.0 x 0.7 in)
<b>Recommended accessories</b>	HP 11851B RF cable kit

### HP 11852B 50 to 75-ohm minimum loss pad

<b>Frequency range</b>	DC to 3.0 GHz
<b>Nominal insertion loss</b>	5.7 dB
<b>Return loss</b>	32 dB (300 kHz to 2 GHz) 27 dB (2 GHz to 3 GHz)
<b>Maximum input power</b>	250 mW (+24 dBm)
<b>Connectors</b>	50-ohm type-N (f) to 75-ohm type-N (m) standard, 50-ohm type-N (m) to 75-ohm type-N (f) with Option 004
<b>Dimensions</b>	14-mm D x 70-mm L (0.56 in x 2.75 in)
<b>Weight</b>	Net 0.1 kg (0.316 lb)

### 50-ohm accessory kits

The HP 11853A 50-ohm type-N and the HP 11854A 50-ohm BNC accessory kits provide the RF components generally required when using either the HP 85046A, HP 85047A or the HP 11850C with the HP 8753E Option 011 when measuring devices having 50-ohm type-N or BNC connectors. These kits are supplied with a storage case.

#### HP 11853A 50-ohm type-N accessory kit

Includes	HP part number
Type-N (f) short	HP 11511A
Type-N (m) short	HP 11512A
Type-N (m) to N (m) adapter	HP 1250-1475
Type-N (f) to N (f) adapter	HP 1250-1472

#### HP 11854A 50-ohm BNC accessory kit

Includes	HP part number
Type-N (m) to BNC female adapter	1250-1476
Type-N (m) to BNC male adapter	1250-1473
Type-N (f) to BNC male adapter	1250-1477
Type-N (f) to BNC female adapter	1250-1474
BNC (m) short	1250-0929

### 75-ohm accessory kits

The HP 11855A 75-ohm type-N and the HP 11856A 75-ohm BNC accessory kits provide the RF components generally required when using either the HP 85046B or the HP 11850D power splitter with the HP 8753E Option 011 when measuring devices having 75-ohm type-N or BNC connectors. These kits are supplied with a storage case.

#### HP 11855A 75-ohm type-N accessory kit

Includes	HP part number
Type-N (f) short	1250-1531
Type-N (m) short	1250-1530
Type-N (m) to N (m) adapter	1250-1528
Type-N (f) to N (f) adapter	1250-1529
Type-N (m) termination	1250-1532

#### HP 11856A 75-ohm BNC accessory kit

Includes	HP part number
Type-N (m) to BNC (f) adapter	1250-1535
Type-N (m) to BNC (m) adapter	1250-1533
Type-N (m) to BNC (m) adapter	1250-1534
Type-N (f) to BNC (m) adapter	1250-1536
BNC (m) short	1250-0929
BNC (m) termination	11652-60010

### RF limiter

Externally attaches to one or both ports of the analyzer. Provides protection against potential high power transients from external devices.

#### Specifications

##### HP 11930A 7-mm RF limiter

<b>Frequency range</b>	DC to 6 GHz
<b>Nominal insertion loss</b>	1.0 dB < 3 GHz 1.5 dB < 6 GHz
<b>Return loss</b>	22 dB < 3 GHz 20 dB < 6 GHz
<b>Maximum input power</b>	3W
<b>Maximum DC</b>	30 V, 350 mA

##### HP 11930B 50-ohm type-N RF limiter\*\*

<b>Frequency range</b>	5 MHz to 6 GHz
<b>Nominal insertion loss</b>	1.0 dB < 3 GHz* 1.5 dB < 6 GHz
<b>Return loss</b>	21 dB < 3 GHz* 17 dB < 6 GHz
<b>Maximum input power</b>	3W

\* Return loss and insertion loss limited below 16 MHz by series capacitor.

\*\* Internal bias tees cannot be used with this limiter.

### HP 85024A high frequency probe

This probe is designed for easy in-circuit sweep measurements. An input capacitance of only 0.7 pF shunted by 1 megohm of resistance permits high frequency probing without adversely loading the circuit. High probe sensitivity allows measurements to be made while taking advantage of the full dynamic range of the instrument. Two probes may be powered directly from the front panel of the HP 8753E. Refer to technical data sheet #5954-8393.

## HP 8753E accessories, cont'd

### Specifications

<b>Input capacitance (at 500 MHz)</b>	<0.7 pF (nominal)
<b>Input resistance</b>	1 Megohm (nominal)
<b>Bandwidth</b>	300 kHz to 3 GHz
<b>Gain (at 500 MHz)</b>	0 dB $\pm$ 1 dB
<b>Frequency response</b>	$\pm$ 1 dB (300 kHz to 1 GHz) +2, -3 dB, (1 GHz to 3 GHz)
<b>Input voltage for &lt; 1 dB compression</b>	0.3 V
<b>Supplement characteristics</b>	
<b>Noise figure</b>	< 50 dB (<100 MHz) < 25 dB (100 MHz to 3 GHz)

Includes	HP part/model number
Type-N (m) adapter	11880A
10:1 divider	11881A
Spare 12 mil probes	85024-20012
2.5-inch ground lead	01223-61302
Hook tip	10229
Spanner tip	5060-0549
Probe tip nut driver	8710-1806

### HP 8347A RF amplifier

This general purpose broadband amplifier is designed for maximum reliability and configured for convenience when interfacing with the HP 8753E. The HP 8347A RF amplifier delivers increased power across a 300 kHz to 3 GHz frequency range. Adjustable leveled output power between +20 dBm (100 mW) to +5 dBm (3.16 mW) can be achieved.

The HP 8347A provides leveled output power without using an external coupler and detector, since these parts are built-in. The external ALC can be directly connected to the External AM input on the HP 8753E. This capability is especially useful for achieving high dynamic range measurements at faster sweep rates.

### Specifications

<b>Frequency</b>	100 kHz to 3 GHz
<b>Gain</b>	25 dB minimum
<b>Output power (leveled)</b> (adjustable)	+5 dBm to +20 dBm
<b>Maximum output power</b>	24 dBm (typical)
<b>Leveled power flatness</b>	$\pm$ 1.5 dB
<b>Impedance</b>	50 ohms nominal
<b>SWR</b>	
<b>Input</b>	2.2:1 max
<b>Output</b>	1.6:1 (ALC on)
<b>Spectral purity</b>	
<b>Harmonics</b>	-20 dBc at dBm
<b>Third order intercept</b>	+30 dBm (nominal)
<b>Typical noise figure</b>	13.5 dB (100 MHz to 3 GHz)
<b>RF connectors</b>	Type-N female
<b>Dimensions</b>	102-mm H x 213-mm W x 297-mm D (4.0 in x 8.4 in x 11.7 in)
<b>Weight</b>	net 3.5 kg (7.7 lb)

### HP 11608A transistor fixture

Provides the capability of completely characterizing stripline transistors when used with the HP 8753E or the HP 85046A or HP 85047A S-parameter test sets. A through-line microstrip and bolt-in grounding structure machinable for special packages is included.

### Specifications

<b>Frequency range</b>	DC to 12.4 GHz
<b>Impedance</b>	50 ohms nominal
<b>Return loss</b>	> 26 dB to 4 GHz; > 23 dB, 4 to 8 GHz; > 19 dB, 8 to 12.4 GHz
<b>Package styles</b>	
Option 003	0.205 in diameter packages. Includes a short circuit termination and a 50 ohm through-section for calibration.
<b>Connectors</b>	7-mm precision

### HP 85043D systems cabinet

The HP 85043D systems cabinet has been ergonomically designed specifically for the HP 8753E Option 011 and the HP 85046A/B or HP 85047A S-parameter test sets. The 132 cm (52-in) system cabinet includes a bookcase, a drawer, and a convenient work surface.

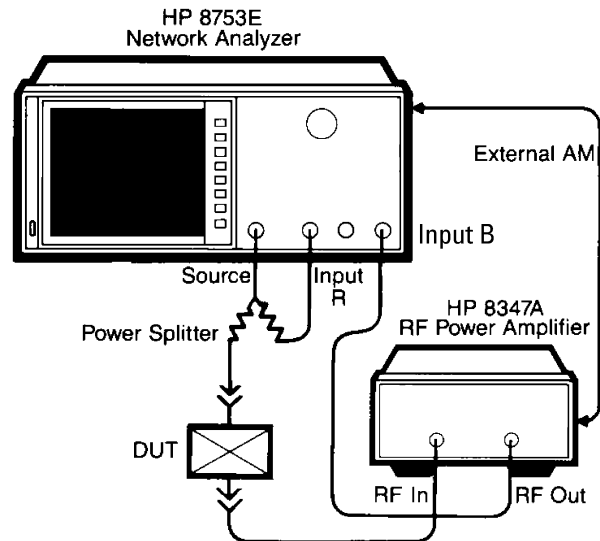

Extended dynamic range test configuration





**For more information about Hewlett-Packard test and measurement products, applications, services, and for a current sales office listing, visit our web site, <http://www.hp.com/go/tmdir>. You can also contact one of the following centers and ask for a test and measurement sales representative.**

**United States:**

Hewlett-Packard Company  
Test and Measurement Call Center  
P.O. Box 4026  
Englewood, CO 80155-4026  
1 800 452 4844

**Canada:**

Hewlett-Packard Canada Ltd.  
5150 Spectrum Way  
Mississauga, Ontario L4W 5G1  
(905) 206 4725

**Europe:**

Hewlett-Packard  
European Marketing Centre  
P.O. Box 999  
1180 AZ Amstelveen  
The Netherlands  
(31 20) 547 9900

**Japan:**

Hewlett-Packard Japan Ltd.  
Measurement Assistance Center  
9-1, Takakura-Cho, Hachioji-Shi,  
Tokyo 192, Japan  
Tel: (81) 426-56-7832  
Fax: (81) 426-56-7840

**Latin America:**

Hewlett-Packard  
Latin American Region Headquarters  
5200 Blue Lagoon Drive, 9th Floor  
Miami, Florida 33126, U.S.A.  
(305) 267 4245/4220

**Australia/New Zealand:**

Hewlett-Packard Australia Ltd.  
31-41 Joseph Street  
Blackburn, Victoria 3130, Australia  
1 800 629 485

**Asia Pacific:**

Hewlett-Packard Asia Pacific Ltd.  
17-21/F Shell Tower, Times Square,  
1 Matheson Street, Causeway Bay,  
Hong Kong  
Tel: (852) 2599 7777  
Fax: (852) 2506 9285

**Data Subject to Change  
Copyright © 1998  
Hewlett-Packard Company  
Printed in U.S.A. 2/98  
5966-0054E**

**For more information on the HP 8753E RF network analyzer, see HP's  
Web site at <http://www.tmo.hp.com/tmo/datasheets/English/HP8753E.html>**