



Agilent 81150A and 81160A Pulse Function Arbitrary Noise Generators Data Sheet, Version 1.1

Which
Product
Meets
Your
Needs?



High precision pulse generators enhanced with versatile signal generation, modulation and distortion capabilities for:

- Accurate signals to test your device and not your signal source
- Versatile waveform and noise generation to be ready for today's and tomorrow's stress test challenges
- Optional pattern generator to test in addition to analog, digital and mixed signal devices
- Integrated into one instrument to minimize cabling, space and test time



Agilent Technologies

The 81150A Pulse Function Arbitrary Noise Generator at a Glance

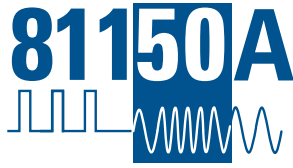

- 1 μ Hz – 120 MHz pulse generation with variable rise/fall time
- 1 μ Hz – 240 MHz sine waveform output
- 14-bit, 2 GSa/s arbitrary waveforms
- 512k samples deep arbitrary waveform memory per channel
- Pulse, sine, square, ramp, noise and arbitrary waveforms
- Noise, with selectable crest factor, and signal repetition time of 26 days
- FM, AM, PM, PWM, FSK modulation capabilities
- 1 or 2 channel, coupled and uncoupled
- Differential outputs
- Two selectable output amplifiers:
 - High bandwidth amplifier
Amplitude: 50 mV_{pp} to 5 V_{pp}; 50 Ω into 50 Ω
100 mV_{pp} to 10 V_{pp}; 50 Ω into open

Voltage window: ± 5 V; 50 Ω into 50 Ω
 ± 10 V; 50 Ω into open
 ± 9 V; 5 Ω into 50 Ω
 - High voltage amplifier
Amplitude: 100 mV_{pp} to 10 V_{pp}; 50 Ω into 50 Ω , 200 mV_{pp} to 20 V_{pp};
5 Ω into 50 Ω , or 50 Ω into open

Voltage window: ± 10 V; 50 Ω into 50 Ω
 ± 20 V; 5 Ω into 50 Ω or 50 Ω into open
- Glitch free change of timing parameters (delay, frequency, transition time, width, duty cycle)
- Programming language compatible with Agilent 81101A, 81104A, 81105A, 81110A, 81130A and 81160A
- ISO 17025 and Z540.3 calibration
- LXI class C (rev. 1.1) compliant
- Optional pattern generator:
 - Ideal and arbitrary bit shaped pattern up to 120 Mbit/s
 - Two, three or four level signals
 - PRBS up to 2^{31}
 - 16 Mbit pattern memory
 - Pass through pattern for combined and physical and protocol test up to 10 Mbit/s

The 81160A Pulse Function Arbitrary Noise Generator at a Glance

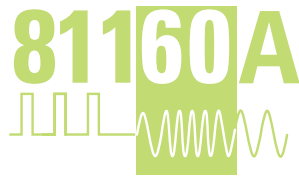

- 1 μHz – 330 MHz pulse generation with variable rise/fall time
- 1 μHz – 500 MHz sine waveform output
- 14-bit, 2.5 GSa/s arbitrary waveforms
- Up to 256k samples deep arbitrary waveform memory per channel
- Pulse, sine, square, ramp, noise and arbitrary waveforms
- Noise, with selectable crest factor, and signal repetition time of 20 days
- FM, AM, PM, PWM, FSK modulation capabilities
- 1 or 2 channel, coupled and uncoupled
- Differential outputs
 - Amplitude:

| | |
|------------------------------|--|
| 50 Ω into 50 Ω | 50 mV _{pp} to 5 V _{pp} |
| 50 Ω into open | 100 mV _{pp} to 10 V _{pp} |
 - Voltage window:

| | |
|------------------------------|------------|
| 50 Ω into 50 Ω | ± 5 V |
| 50 Ω into open | ± 10 V |
- Glitch free change of timing parameters (delay, frequency, transition time, width, duty cycle)
- Programming language compatible with Agilent 81101A, 81104A, 81105A, 81110A, 81130A and 81150A
- ISO 17025 and Z540.3 calibration
- LXI class C (rev 1.1) compliant
- Optional pattern generator:
 - Ideal and arbitrary bit shaped pattern up to 330 Mbit/s (Option 330) or 660 Mbit/s (Option 660)
 - Two, three or four level signals
 - PRBS up to 2^{31}
 - 4 Mbit pattern memory for the 1-channel instrument and 2 Mbit per channel for the 2-channel instrument
 - Pass through pattern for combined and physical and protocol test up to 10 Mbit/s

81150A

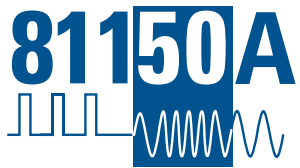
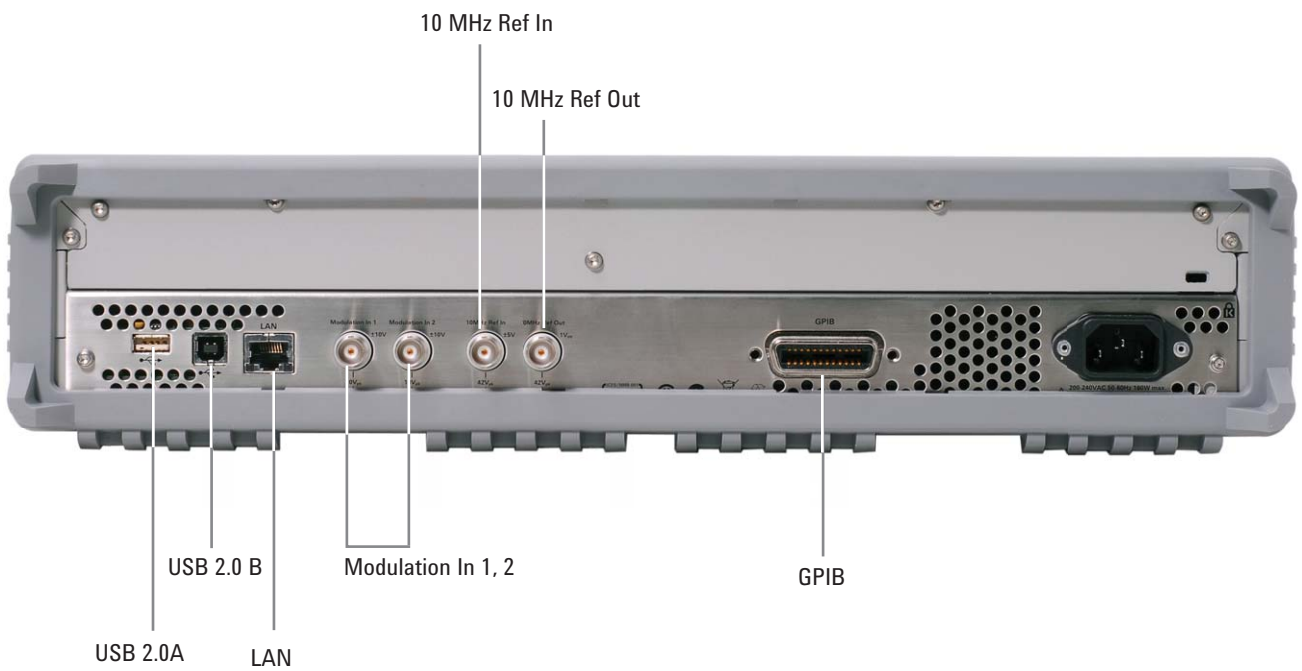
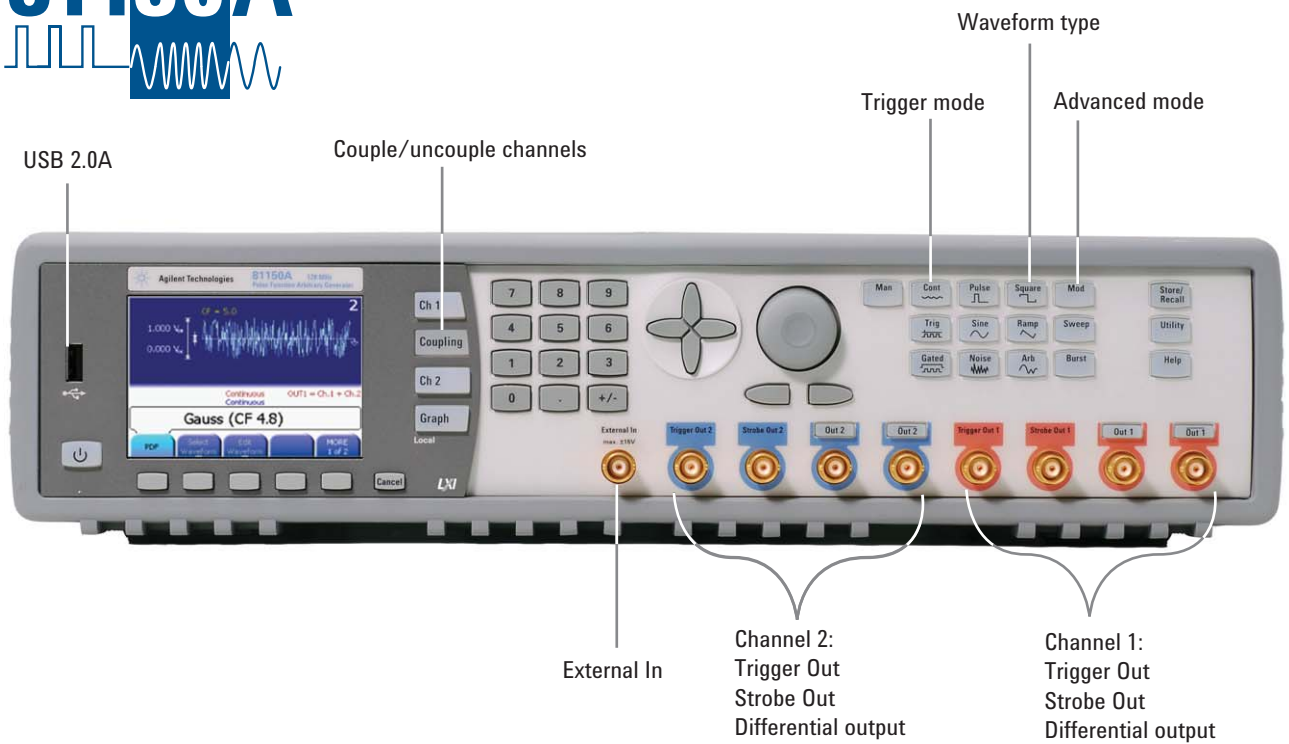
81160A

Today's Challenges Require a New Generation of Test Instruments

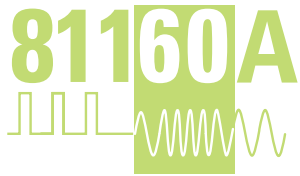
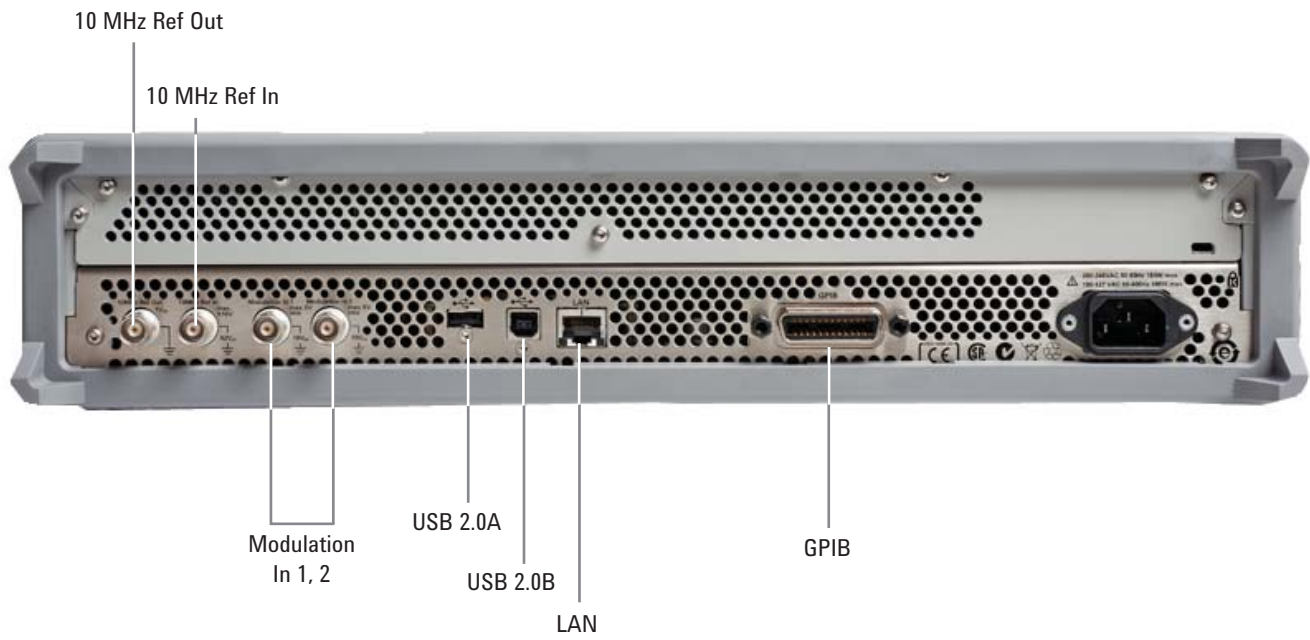
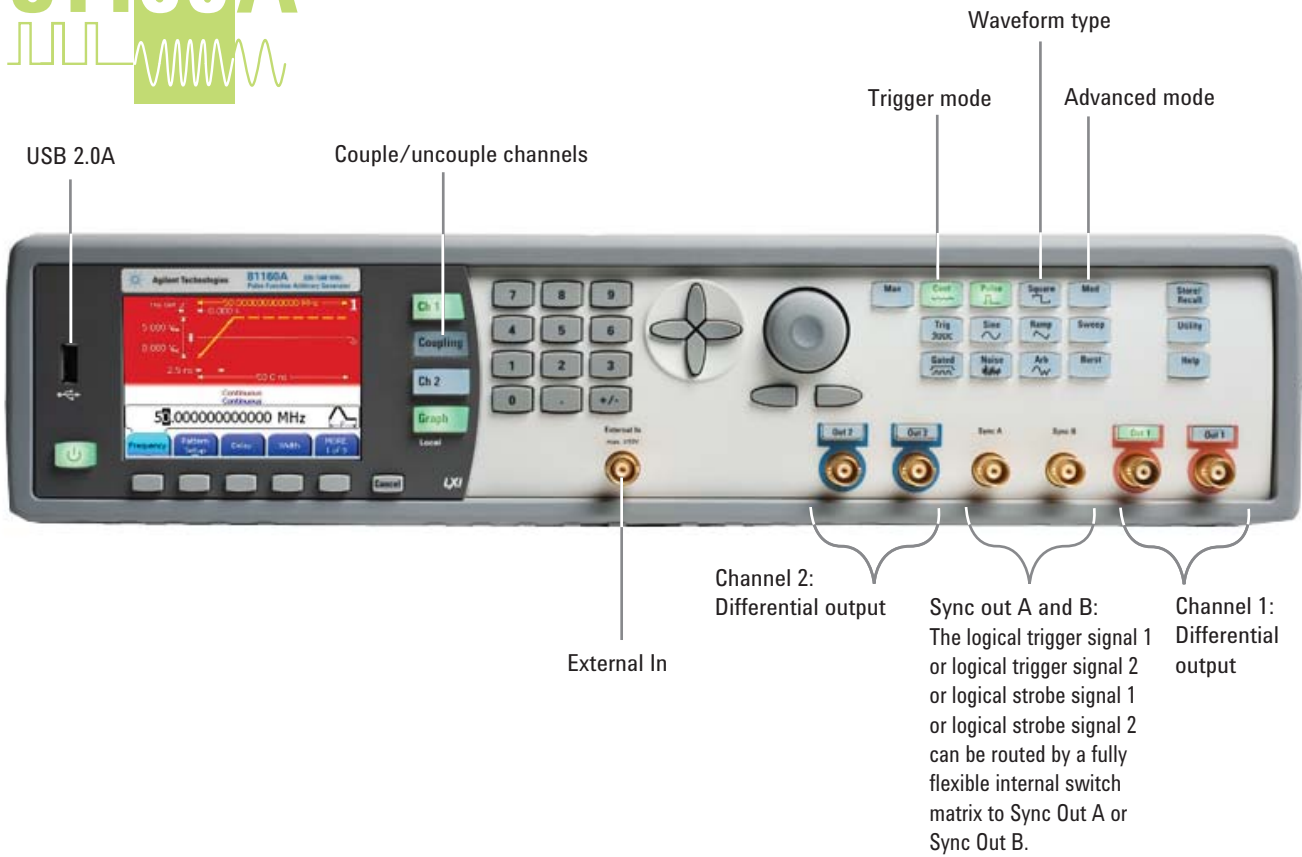
You are under pressure to get products to market faster and faster, with shrinking design schedules and increasing quality goals. The pressure is never ending. Because differentiation means survival in the marketplace, you often have to test unique functionality. Being confident in your results takes highly adaptable and efficient testing.

Such challenges require a new generation of test instruments, which are:

- Accurate, to test your device and not your source
- Versatile, to be ready for today's and tomorrow's test challenges
- Plug and play solutions, with minimal cabling, low space overhead and have many functions built-in

Whichever way you look at it, this starts with accurate, versatile and uncompromising signal sources.

Just test – with the signal you need.
Quad versatility – optimum signal fidelity

Agilent's offering

The Agilent 81150A and 81160A Pulse Function Arbitrary Noise Generators set the standard for the next generation of lab: for fast, accurate insight into your design or device under test. Both of them offer:

- Pulse generators with precise signals for performance verification and characterization
- A function arbitrary generator
 - For versatile signal generation to optimize testing
 - For modulation to shape the signal the DUT needs
- A noise generator to distort signals to build up worst case scenarios
- An optional pattern generator to test in addition to analog, digital and mixed signal devices with ideal and real-world conditions

The Agilent 81150A and the new Agilent 81160A Pulse Function Arbitrary Noise Generators are indispensable contributors to accelerate ideal and real-world testing.

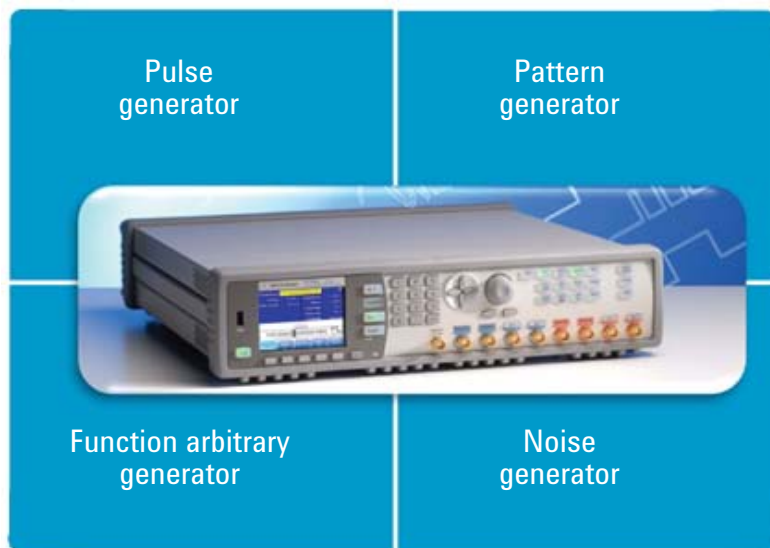

Figure 1. Agilent 81150A and 81160A Pulse Function Arbitrary Noise Generator

Pulse Generator – Test Your Device and Not Your Source

Superior precision pulses with unbeatable timing stability guarantee reproducible tests. The signal quality and trigger functionality provide everything you need for trigger or system clock applications.

You can change the timing parameters (delay, frequency, transition time, width, duty cycle) without dropouts or glitches. This patented, industry-leading feature means continuous operation without having to reboot or reset your device under test, for example when you are characterizing a device by sweeping the clock frequency. Apart from full control of the timing parameters, you can also adjust levels and edges as needed.

Channel 1 pulse setup

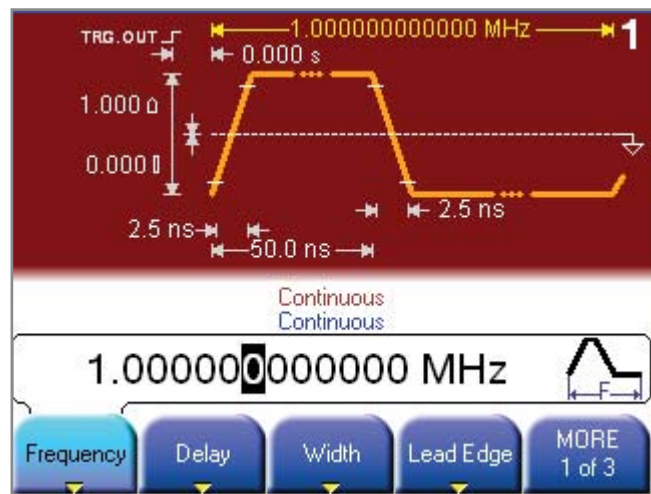

Set up complex measurements

Both, the Agilent 81150A and the Agilent 81160A Pulse Function Arbitrary Noise Generator, are available in a 1 or 2 channel version. On the two channel version, the channels can be uncoupled, to work independently, or coupled, for example, with a defined delay between them.

Each channel provides Trigger Out, Strobe Out and differential outputs: the basis for many complex test setups.

Measurement using strobe and trigger

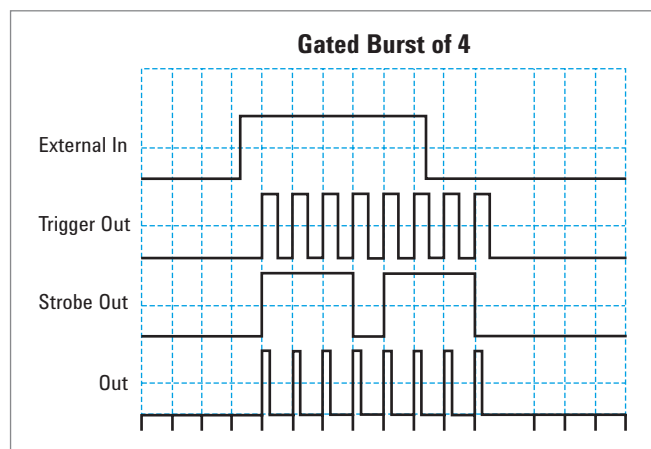

Function Arbitrary Generator – Stress Your Device to its Limit

If you need further signal conditioning, the Agilent 81150A and the Agilent 81160A Pulse Function Arbitrary Noise Generators provide versatile waveforms and modulation capabilities to adapt your signal to your device's requirements. AM, FM, FSK, PM and PWM are available at modulation frequencies up to 10 MHz and to 50 MHz.

The Agilent 81150A and the Agilent 81160A Pulse Function Arbitrary Noise Generators can use internal or external modulation sources. Internal modulation can be generated from the 2nd channel or the internal modulation source of the modulated channel.

Amplitude modulation

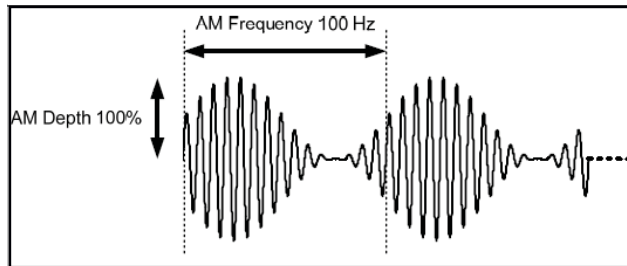

Frequency shift keying modulation

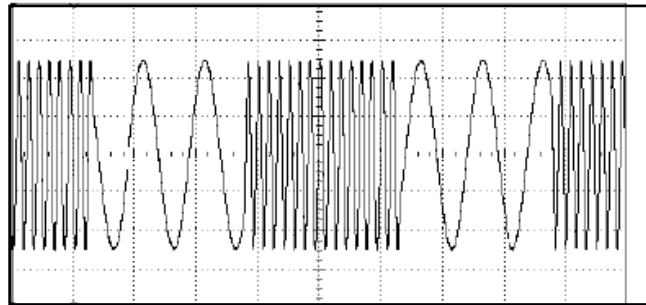

Pulse width modulation

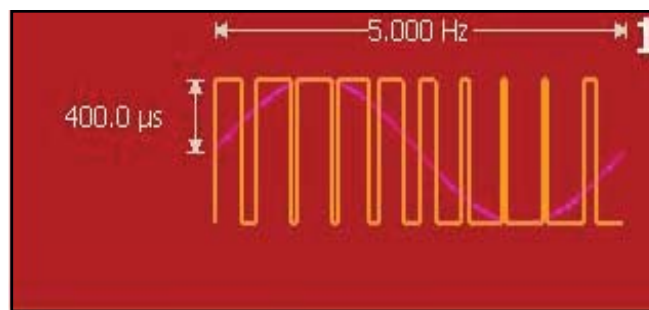

Frequency sweep

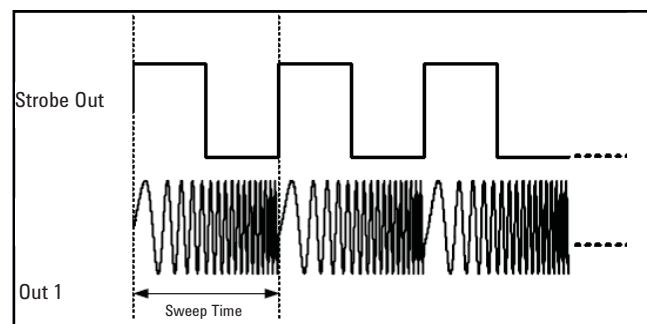

Setting up a measurement using trigger, strobe, modulation and carrier

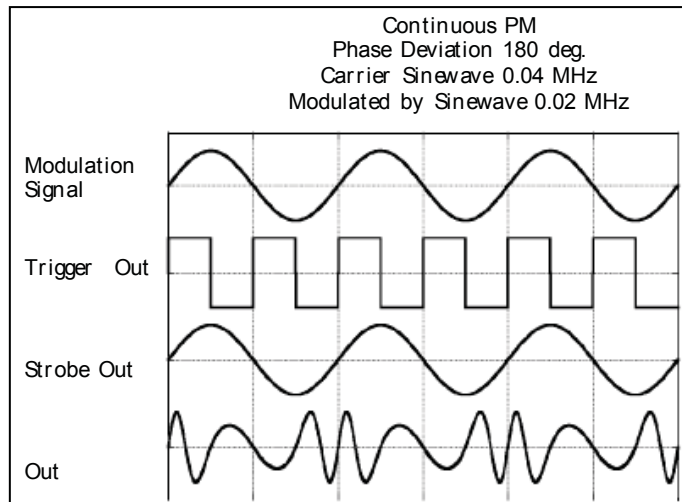

Noise generator – repeatable and stochastic noise

Jitter and noise cause misalignment of edges and levels, resulting in data errors. Noise is by its nature unpredictable because it can have many different causes, from signal interference caused by sudden voltage changes, to distortions introduced during transmission.

It is important to be able to simulate noise-based malfunctions, for example, to identify the additive noise produced by receiving systems—it is cheaper to lower the noise figure than to increase the transmitter power! The Agilent 81150A and the Agilent 81160A Pulse Function Arbitrary Noise Generators let you control the quality of the noise, to test different cases, and according to various specifications.

White Gaussian noise is a good approximation to many real-world situations, and creates mathematically traceable models, with statistical independent values. The Agilent 81150A and the Agilent 81160A Pulse Function Arbitrary Noise Generators provide deterministic white Gaussian noise, with a signal repetition of 20 days or 26 days respectively. You can decide on any arbitrary distribution, and trigger the noise to start when you need it.

Gaussian curve and distribution

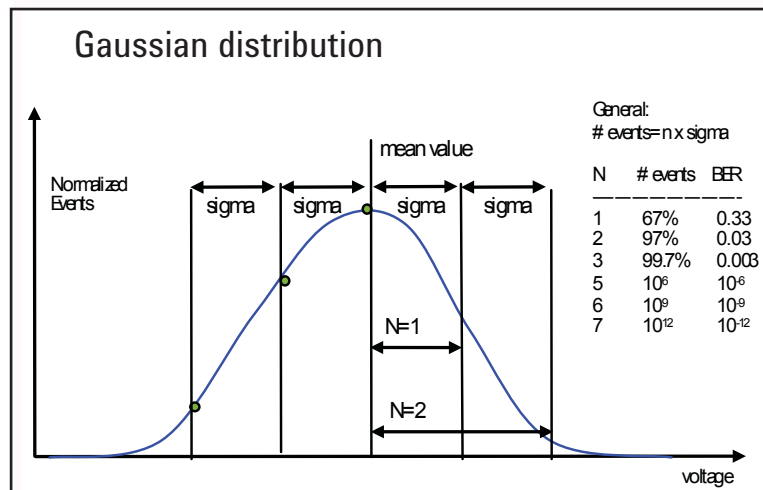

Voltage level crest factor

You can also select the crest factor out of 4 values – an indicator of signal quality – using V_p/V_{RMS} or V_{pp}/V_{RMS} scales, depending on the standard to which you are testing.

The 81150A and the 81160A use the definition: crest factor = V_p/V_{RMS}

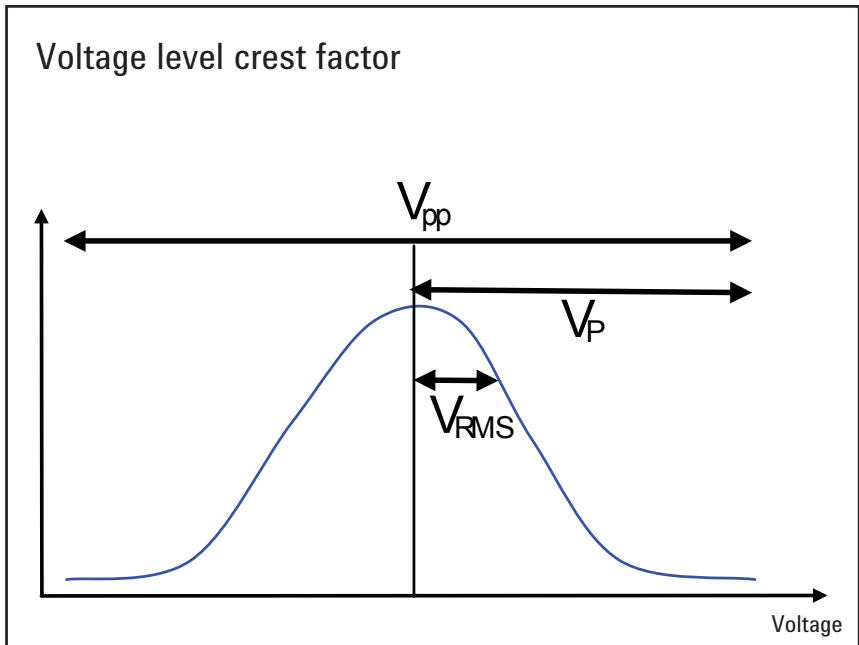

The result is noise that combines two extremes:

- Random and repeatable noise, for stress tests on one side
- While still being sufficiently random

Pattern Generator – Test in Addition to Analog, Digital and Mixed Signal Devices

Engineers working with serial buses or designers of analog, digital and mixed signal devices require stressing their design with pattern. The optional Agilent 81150A and 81160A arbitrary bit shaped pattern generator allows sending ideal and real-world pattern. The Agilent 81150A with arbitrary bit shaped pattern (Option PAT) allows emulating overshoot, asymmetric delay and duty cycle distortion up to 120 Mbit/s, the Agilent 81160A up to 330 Mbit/s (Option 330) or even up to 660 Mbit/s (Option 660). Patterns can be easily set up and distorted at your fingertips.

Stress your device to its limits – define your own bit shape

| | |
|--|--|
| Emulate effects like... | |
| <ul style="list-style-type: none"> • Capacitive load of the channel • Asymmetric delay • Crossing point deviations • Duty cycle distortions • Arbitrary transition times • Level noise • Delays from/to electrical idle | <p>NRZ NRZ mode with minimum transition times NRZ mode with transition time = 1/3 period</p> <p>Mode Data pattern: 01001101</p> |
| <p>...By defining the transitions so that the previous bit influences the current bit</p> | <p>Arbitrary NRZ mode with minimum transition times</p> <p>Bit shape Bit shape waveforms (user defined)</p> <p>Mode Output waveform</p> |

The 81150A and the 81160A pattern generators let you define the transitions from one bit to the other so that the previous bit influences the current bit. The user can set up own defined arbitrary bit shapes.

PRBS

In addition to user-defined patterns, standard patterns like PRBS up to 2³¹ are available.

Sequencer

The sequencer allows setting up a pre-amble sequence so that the device under test moves into test mode.

2-, 3- and 4-level signals

Additionally to 2-level signals, it is also possible to create 3- and even 4-level signals. With the 3-level signals, it is no longer necessary to add different signals for electrical idle. 3-level signals are important e.g. for use in Ethernet environment and 4-level signals e.g. for PAM4 applications.

Bit and block trigger mode

Besides, standard trigger modes like continuous bit and block trigger modes allow adoptions to application needs. In the bit mode you see that on every trigger, the sequence is advanced by one bit. An application example is a bit clock, which can be fed into an external clock and then into the trigger input.

In the block mode the entire data block is generated once per trigger event. This is interesting for example in applications with protocol data.

Pass through pattern for combined physical and protocol test up to 10 Mbit/s

The 81150A and the 81160A pattern generators pass the data through to the device under test and adopts it to any kind of stress test (shape and timing change).

Bridge the gap between protocol and physical layer test – in real time up to 10 Mbit/s

Increase your test efficiency by combining physical layer test with protocol test

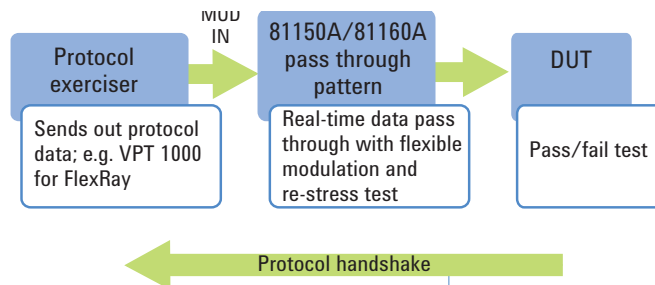

The pass-through pattern functionality takes the protocol data via “mod in” and adopts it to any kind of stress test (shape and timing changes).

Modulation

Modulation of the pattern signal enables you to emulate real-world conditions.

AM – amplitude of the pattern signal is multiplied by the modulation signal to emulate level distortions of the data signal e.g. sinusoidal interference.

FM – frequency of the pattern signal is modulated to emulate SSC on the data signal.

PM – the phase of the data bits is modulated to emulate jitter on the data signal.

Connectivity

Filling the arbitrary memory easily

There are several possibilities for filling the arbitrary memory. There are 6 built-in, standard arbitrary waveforms, but you can also create any waveform you need, either on the instrument or on a PC, using the IntuiLink waveform editor for the 81150A or the Agilent 33503A BenchLink Waveform Builder Pro available soon for the 81150A and 81160A Pulse Function Arbitrary Noise Generators.

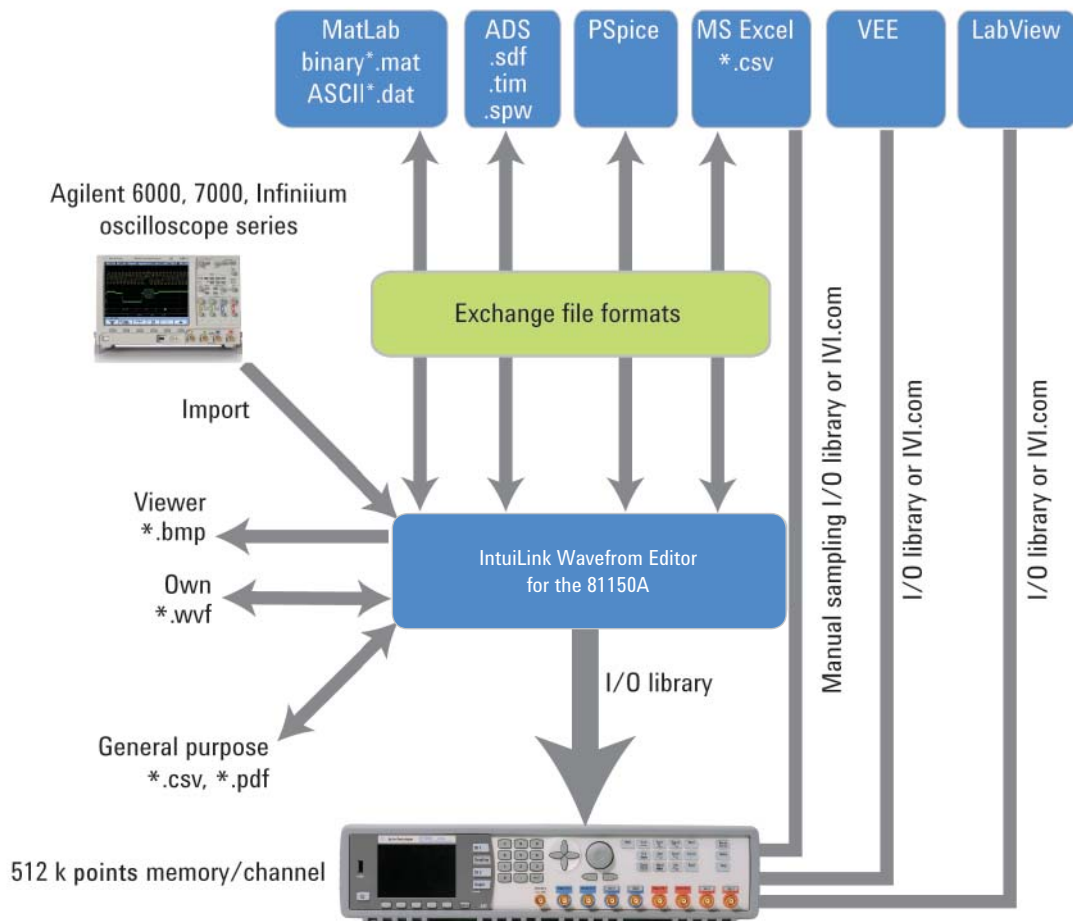

Measurement – Anywhere and Anytime

The web interface allows you to use the full functionality and feature set of the Agilent 81150A and 81160A Pulse Function Arbitrary Noise Generators from a web browser.

Channel 1: instrument view

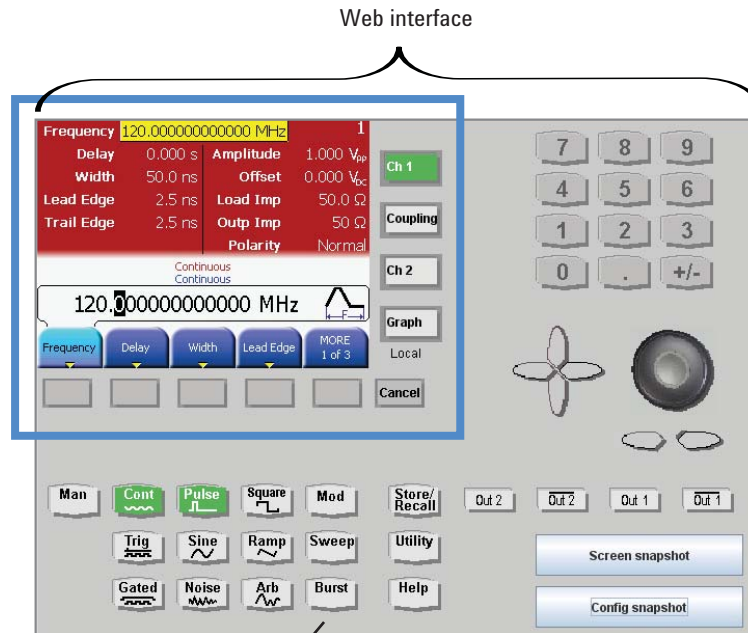

Just decide on the waveform

Channel 2

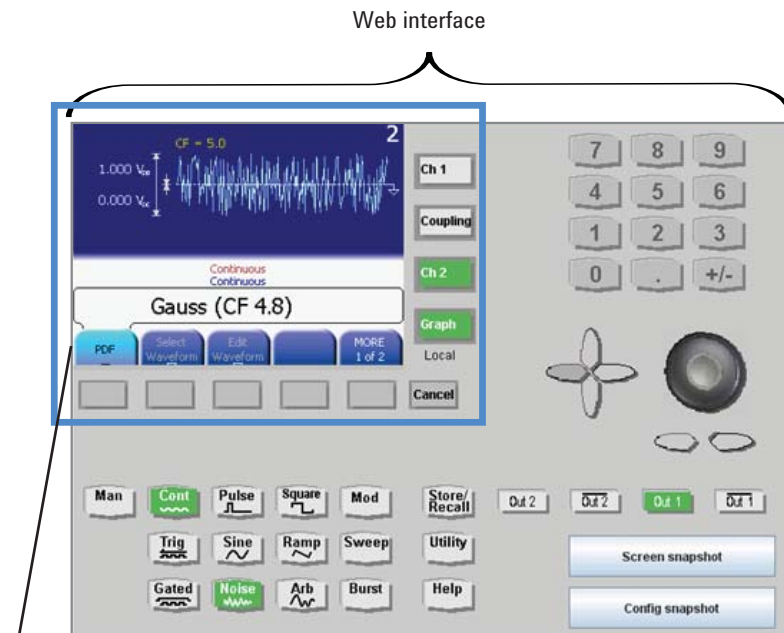

Choose the crest factor / probability function you need

Amplifier concept

Different applications and devices call for different bandwidth and voltage levels. Choose the performance you need.

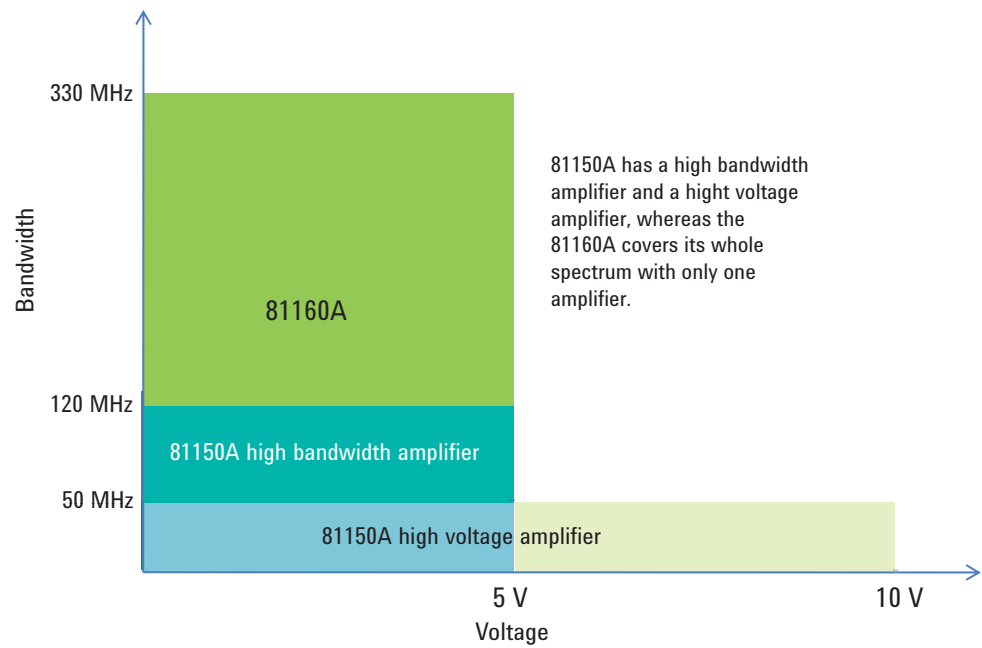

Flexible signal synchronization

The 81150A has one trigger output and one strobe output per channel.



The 81160A generates the trigger signal and the strobe signal per channel internally. Using a fully configurable switch matrix, two of the four internal signals can be routed to Sync Out A or Sync Out B.

81160A: Sync
Out A and B

Modes of Operation

There are four components to the mode of operation:

- Coupling between channels
- Trigger mode
- Waveform type
- Advanced modes

Coupling between channel 1 and 2

The two channel version has two distinct modes of operation:

- **Coupling off:** The two channels operate independently. Frequency generation for both channels is based on the same clock reference, but can be selected independently.
- **Coupling on:** The frequency, trigger mode, waveform type and advanced mode are identical for both channels. The fix delay of channel 1 and channel 2 is the same.

Trigger modes

- **Continuous:** Continuous waveform, burst, sweep or modulation. The external in is not used in continuous mode.
- **Externally triggered:** Each active transition at the external in (rising, falling or both) generates a single waveform, burst or sweep.
- **Externally gated:** The active level (high or low) at the external in enables waveforms, bursts or sweeps. The last waveform, burst or sweep is always completed.
- **Internally triggered:** The internal clock replaces the external trigger source. This can be applied for waveform, burst, or sweep.
- **Manual:** This generates a single trigger. The source is either a button on the front panel or a remote command.

Trigger rate (internally triggered)

81150A: 1 μ Hz to 120 MHz

81160A: 1 μ Hz to 330 MHz

Trigger rate (externally triggered)

81150A: DC to 120 MHz

81160A: DC to 330 MHz

Waveform Types

- Standard waveforms: pulse, sine, square, ramp, noise, arbitrary
- Predefined arbitrary waveforms: exponential rise, exponential fall, $\sin(x)/x$, cardiac and DC
- Pulse, sine, ramp, noise and arbitrary measured with 50 Ω source impedance into 50 Ω load impedance.

Pulse characteristics

| | 81150A | 81160A |
|--|----------------------------------|-----------------------------------|
| Frequency range | | |
| High bandwidth amplifier | 1 μ Hz to 120 MHz | 1 μ Hz to 330 MHz |
| High voltage amplifier | 1 μ Hz to 50 MHz | |
| Frequency resolution | 1 μ Hz | 1 μ Hz |
| Pulse width | | |
| Range | | |
| High bandwidth amplifier | 4.1 ns to (period - 4.1 ns) typ. | 1.5 ns to (period - 1.5 ns) spec. |
| High voltage amplifier | 10 ns to (period - 10 ns) | |
| Resolution | 100 ps, 6 digits | 100 ps, 6 digits |
| Accuracy | ± 500 ps ± 50 ppm | ± 300 ps ± 50 ppm |
| Transition time (independent rise and fall) | | |
| Range | | |
| High bandwidth amplifier | 2.5 ns to 1000 s (10% to 90%) | 1.0 ns to 1000 s (10% to 90%) |
| High voltage amplifier | 7.5 ns to 1000 s (10% to 90%) | |
| Resolution | 100 ps, 6 digits | 100 ps, 6 digits |
| Accuracy | | |
| High bandwidth amplifier | ± 500 ps ± 50 ppm | ± 300 ps ± 50 ppm |
| High voltage amplifier | -1000 ps to +500 ps ± 50 ppm | |
| Overshoot | 2% typ. ⁽¹⁾ | 4% typ. ⁽²⁾ |

1) Overshoot disappears for transition times > 5 ns (high bandwidth amplifier) and > 15 ns (high voltage amplifier).

2) Overshoot disappears for transition times > 2 ns.

Sine characteristics

| | 81150A | 81160A |
|--|-----------------------|---------------------------------|
| Frequency range | | |
| High bandwidth amplifier | 1 μ Hz to 240 MHz | 1 μ Hz to 500 MHz |
| High voltage amplifier | 1 μ Hz to 50 MHz | |
| Frequency resolution | 1 μ Hz | 1 μ Hz |
| Harmonic distortion (High bandwidth amplifier 50 Ω into 50 Ω) | | |
| | 1 V_{PP} | 3 V_{PP} |
| | 1 μ Hz to 2 MHz | < -62 dBc spec. < -62 dBc spec. |
| | 2 MHz to 10 MHz | < -57 dBc spec. < -52 dBc spec. |
| | 10 MHz to 35 MHz | < -45 dBc spec. < -40 dBc spec. |
| | 35 MHz to 70 MHz | < -35 dBc spec. < -30 dBc spec. |
| | 70 MHz to 240 MHz | < -22 dBc spec. < -17 dBc spec. |
| | 1 V_{PP} | 3 V_{PP} |
| | 1 μ Hz to 2 MHz | < -65 dBc spec. < -63 dBc spec. |
| | 2 MHz to 10 MHz | < -62 dBc spec. < -53 dBc spec. |
| | 10 MHz to 50 MHz | < -50 dBc spec. < -40 dBc spec. |
| | 50 MHz to 200 MHz | < -30 dBc spec. < -27 dBc spec. |
| | 200 MHz to 500 MHz | < -22 dBc spec. < -20 dBc spec. |
| Harmonic distortion (High voltage amplifier 50 Ω into 50 Ω) | | |
| | 10 V_{PP} | |
| | 1 μ Hz to 8 MHz | < -40 dBc |
| | 8 MHz to 50 MHz | < -25 dBc |
| Non-harmonic (spurious) distortion | | |
| | 1 μ Hz to 20 MHz | -60 dBc typ. |
| | 20 MHz to 200 MHz | -55 dBc typ. |
| | 200 MHz to 240 MHz | -50 dBc typ. |
| | 1 μ Hz to 1 MHz | -50 dBc typ. |
| | 1 MHz to 10 MHz | -55 dBc typ. |
| | 10 MHz to 280 MHz | -50 dBc typ. |
| | 280 MHz to 330 MHz | -45 dBc typ. |
| | 330 MHz to 500 MHz | -43 dBc typ. |
| SSB phase noise (10 kHz offset) | | |
| 1 MHz | -119 dBc/Hz typ. | -115 dBc/Hz typ. |
| 10 MHz | -115 dBc/Hz typ. | -115 dBc/Hz typ. |
| 100 MHz | | -110 dBc/Hz typ. |
| 240 MHz | -93 dBc/Hz typ. | |
| 500 MHz | | -100 dBc/Hz typ. |

Square characteristics

| | 81150A | 81160A |
|-------------------------------------|---|--|
| Frequency range | | |
| High bandwidth amplifier | 1 μ Hz to 120 MHz | 1 μ Hz to 330 MHz |
| High voltage amplifier | 1 μ Hz to 50 MHz | |
| Frequency resolution | 1 μ Hz | 1 μ Hz |
| Duty cycle | | |
| High bandwidth amplifier | (Freq/240 MHz) to 1 - (Freq/240 MHz) e.g. 60 MHz; 25% to 75% | (Freq/ 660 MHz) to 1 - (Freq/ 660 MHz) e.g. 115 MHz; 25% to 75% |
| High voltage amplifier | (Freq/100 MHz) to 1 - (Freq/100 MHz) e.g. 1 MHz 1% to 99% | e.g. 3.3 MHz; 0.5% to 99.5% |
| Resolution | 0.1% | 0.1% |
| Transition time (10% to 90%) | | |
| High bandwidth amplifier | 2.5 ns typ. fixed | 1.1 ns typ. fixed |
| High voltage amplifier | 6 ns typ. fixed | |
| Overshoot | 2% typ. | 4% typ. |

Ramp characteristics

| | 81150A | 81160A |
|-----------------------------|---------------------|----------------------|
| Frequency range | 1 μ Hz to 5 MHz | 1 μ Hz to 20 MHz |
| Frequency resolution | 1 μ Hz | 1 μ Hz |
| Linearity | < 0.1% (f < 10 kHz) | < 0.1% (f < 10 kHz) |
| Symmetry | 0.0% to 100% | 0.0% to 100% |

Noise characteristics

| | 81150A | 81160A |
|---|--|--|
| Bandwidth | | |
| High bandwidth amplifier | 120 MHz typ. | 160 MHz typ. |
| High voltage amplifier | 40 MHz typ. | |
| Amplitude distribution | Selectable Gaussian, user defined | Selectable Gaussian, user defined |
| Crest factor (peak/RMS) selectable | 3.1, 4.8, 6.0, 7.0 typ. (Gaussian distribution) | 3.1, 4.8, 6.0, 7.0 typ. (Gaussian distribution) |
| Noise type | Deterministic, triggerable | Deterministic, triggerable |
| Repetition time | ~ 26 days | ~ 20 days |

Arbitrary characteristics

| | 81150A | 81160A |
|--|---|---|
| DAC sample rate | 2 GSa/s ⁽¹⁾ , fixed | 2.5 GSa/s, fixed |
| Waveform length | 2 to 512k points | 1 channel instrument: 2 to 256k points 2 channel instrument: 2 to 128k points |
| Wavelength vs. memory access rate | 2 to 512k points at memory access rate 1,000 MSa/s ⁽¹⁾ | 1 channel instrument, automatic selection: 128k to 256k points at memory access rate 625 MSa/s ⁽²⁾ 64k to 128k points at memory access rate 1,250 MSa/s ⁽³⁾ 2 to 64k points at memory access rate 2,500 MSa/s 2 channel instrument, automatic selection: 64k to 128k points at memory access rate 625 MSa/s ⁽²⁾ 32 to 64k points at memory access rate 1,250 MSa/s ⁽³⁾ 2 to 32k points at memory access rate 2,500 MSa/s |
| DAC resolution | 14 bits | 14 bits |
| Frequency range | 1 μ Hz to 120 MHz | 1 μ Hz to 330 MHz |
| Frequency resolution | 1 μ Hz | 1 μ Hz |
| Transition time (10% to 90%) | | |
| High bandwidth amplifier | 1.7 ns typ. | 1.0 ns typ. |
| High voltage amplifier | 5 ns typ. | |
| Filter bandwidth | | |
| High bandwidth amplifier | 240 MHz typ. | 500 MHz typ. |
| High voltage amplifier | 80 MHz typ. | |
| PP jitter | 1 ns typ. | 400 ps typ. at memory sample rate 2,500 MSa/s |

1) One step linear interpolation between two memory samples. DAC clock rate is 2,000 MSa/s.

2) Three steps linear interpolation between two memory samples. DAC clock rate is 2,500 MSa/s.

3) One step linear interpolation between two memory samples. DAC clock rate is 2,500 MSa/s

Advanced Modes

Three advanced modes exist:

- **Modulation:** selects the modulation type: AM, FM, PM, FSK, PWM
- **Sweep:** for frequency sweeps
- **Bursts:** repeats selected waveform n times

Modulation

A modulation input (for AM, FM, PM, FSK, PWM) for each channel is provided on the back-panel. In the two channel instrument one channel can also modulate the other channel.

Modulation In 1/modulation In 2

| | 81150A | 81160A |
|---------------------------------|---|---|
| Input range (full scale) | Selectable ± 2.5 V or ± 5 V | ± 2.5 V |
| Frequency range | DC to 10 MHz | DC to 10 MHz |
| Input impedance | Selectable 10 k Ω , 50 Ω nom. | Selectable 10 k Ω , 50 Ω nom. |
| Connector | BNC, back panel | BNC, back panel |

AM

| | 81150A | 81160A |
|---|--|--|
| Carrier waveforms | Sine, square, ramp, arbitrary | Sine, square, ramp, arbitrary |
| Internal modulation | Sine, square, ramp (up, 50%, down), noise, arbitrary | Sine, square, ramp (up, 50%, down), noise, arbitrary |
| Modulation frequency | | |
| Internal | 1 mHz to 10 MHz | 1 mHz to 50 MHz |
| External | DC to 10 MHz | DC to 10 MHz |
| Depth | 0% to 120% | 0% to 120% |
| Double-sideband suppressed carrier | Selectable on/off | Selectable on/off |
| Source | Internal, external, channel | Internal, external, channel |

FM

| | 81150A | 81160A |
|-----------------------------|--|--|
| Carrier waveforms | Sine, square, ramp, arbitrary | Sine, square, ramp, arbitrary |
| Internal modulation | Sine, square, ramp (up, 50%, down), noise, arbitrary | Sine, square, ramp (up, 50%, down), noise, arbitrary |
| Modulation frequency | | |
| Internal | 1 mHz to 10 MHz | 1 mHz to 50 MHz |
| External | DC to 10 MHz | DC to 10 MHz |
| Deviation range | 1 μ Hz to 240 MHz ⁽¹⁾ | 1 μ Hz to 500 MHz ⁽¹⁾ |
| Source | Internal, external, channel | Internal, external, channel |

PM

| | 81150A | 81160A |
|-----------------------------|--|--|
| Carrier waveforms | Sine, square, ramp, arbitrary | Sine, square, ramp, arbitrary |
| Internal modulation | Sine, square, ramp (up, 50%, down), noise, arbitrary | Sine, square, ramp (up, 50%, down), noise, arbitrary |
| Modulation frequency | | |
| Internal | 1 mHz to 10 MHz | 1 mHz to 50 MHz |
| External | DC to 10 MHz | DC to 10 MHz |
| Deviation range | 0 to 360° | 0 to 360° |
| Source | Internal, external, channel | Internal, external, channel |

1) Max frequency depends on selected waveform.

FSK

| | 81150A | 81160A |
|----------------------------|-------------------------------------|---------------------------------|
| Carrier waveforms | Sine, square, ramp, arbitrary | Sine, square, ramp, arbitrary |
| Internal modulation | 50% square | 50% square |
| FSK rate | | |
| Internal | 1 mHz to 50 MHz | 1 mHz to 50 MHz |
| External | 1 mHz to 10 MHz | 1 mHz to 10 MHz |
| Frequency range | 1 mHz to 240 MHz ⁽¹⁾ (2) | 1 mHz to 500 MHz ⁽¹⁾ |
| Source | Internal, external, channel | Internal, external, channel |

1) Max frequency depends on selected waveform.

2) For export control: Effective switching time is 40 ns.

PWM

| | 81150A | 81160A |
|-----------------------------|--|--|
| Carrier waveform | Pulse | Pulse |
| Internal modulation | Sine, square, ramp (up, 50%, down), noise, arbitrary | Sine, square, ramp (up, 50%, down), noise, arbitrary |
| Modulation frequency | | |
| Internal | 1 mHz to 10 MHz | 1 mHz to 50 MHz |
| External | DC to 10 MHz | DC to 10 MHz |
| Deviation range | 0% to 100% of pulse width | 0% to 100% of pulse width |
| Source | Internal, external, channel | Internal, external, channel |

Sweep

An independent frequency sweep is provided for each channel.

| | 81150A | 81160A |
|---|--|--|
| Waveforms | Pulse, sine, square, ramp, triangle, arbitrary | Pulse, sine, square, ramp, triangle, arbitrary |
| Type | Linear or logarithmic | Linear or logarithmic |
| Direction | Up or down | Up or down |
| Sweep time | 100 μ s to 500 s | 50 μ s to 500 s |
| Start frequency/stop frequency | 1 μ s to 240 MHz ⁽¹⁾ | 1 μ Hz to 500 MHz ⁽¹⁾ |
| Amplitude flatness (relative to 1 kHz, 2 V_{pp}) | — | 1 μ Hz to 500 MHz \pm 0.5 dB typ. |
| Trigger source | External, internal, manual | External, internal, manual |
| Marker | Frequency marker | Frequency marker |

1) Max frequency depends on selected waveform.

Burst

An independent frequency sweep is provided for each channel.

| | 81150A | 81160A |
|----------------------------------|--|--|
| Waveforms | Pulse, sine, square, ramp, triangle, arbitrary | Pulse, sine, square, ramp, triangle, arbitrary |
| Frequency | 1 μ Hz to 120 MHz | 1 μ Hz to 330 MHz |
| Modes | Externally triggered, internally triggered, externally gated | Externally triggered, internally triggered, externally gated |
| # of waveforms in a burst | 2 to $2^{31} - 1$ (~ 2 billion) | 2 to $2^{31} - 1$ (~ 2 billion) |
| Trigger period | 16.7 ns to 9999 s | 6.1 ns to 9999s |
| Start phase⁽¹⁾ | -360 to +360° | -360 to +360° |
| Gate source | External | External |
| Trigger source | External, internal, manual | External, internal, manual |

1) Available for all waveforms except pulse, square and ramp.

Outputs

Main outputs

A selectable single-ended or differential output is provided for each channel on the front-panel.

Max. frequency

| | 81150A | 81160A |
|---------------------------------|----------------------------|----------------------------|
| High bandwidth amplifier | 120 MHz pulse/240 MHz sine | 330 MHz pulse/500 MHz sine |
| High voltage amplifier | 50 MHz | |

Out 1/Out 2

| | 81150A | 81160A |
|---|--|---|
| Output type | Single-ended or differential | Single-ended or differential |
| Amplitude (50 Ω into 50 Ω) | | |
| High bandwidth amplifier | | |
| 1 μ Hz to 120 MHz | 50 mV _{pp} to 5 V _{pp} ⁽¹⁾ typ. | |
| 120 MHz to 240 MHz | 50 mV _{pp} to 3V _{pp} ⁽¹⁾ typ. | |
| 1 μ Hz to 330 MHz | | 50 mV _{pp} to 5 V _{pp} ⁽¹⁾ spec. |
| 330 MHz to 500 MHz | | 50 mV _{pp} to 3 V _{pp} ⁽¹⁾ spec. |
| High voltage amplifier | | |
| 1 μ Hz to 50 MHz | 100 mV _{pp} to 10 V _{pp} ⁽¹⁾ typ. | |
| Amplitude (50 Ω into open, 5 Ω into 50 Ω) | | |
| High bandwidth amplifier | | |
| 1 μ Hz to 120 MHz | 100 mV _{pp} to 10 V _{pp} ⁽¹⁾ (to 9 V _{pp} ⁽²⁾) | |
| 120 MHz to 240 MHz | 100 mV _{pp} to 5 V _{pp} ⁽¹⁾ | |
| 1 μ Hz to 60 | | 100 mV _{pp} to 10 V _{pp} ⁽¹⁾⁽⁴⁾ |
| High voltage amplifier | | |
| 1 μ Hz to 50 MHz | 200 mV _{pp} to 20 V _{pp} ⁽¹⁾ | |
| DC amplitude accuracy | \pm (1.5% of setting + 5 mV) | \pm (1.5% of setting + 5 mV) |
| Voltage window (50 Ω into 50 Ω) | | |
| High bandwidth amplifier | -5 V to +5 V typ. | -5 V to +5 V spec. |
| High voltage amplifier | -10 V to +10 V typ. | |
| Voltage window (50 Ω into open, 5 Ω into 50 Ω) | | |
| High bandwidth amplifier | -10 V to +10 V ⁽¹⁾ (-9 V to +9 V ⁽²⁾) typ. | - 10 V to + 10 V spec. ⁽⁴⁾ |
| High voltage amplifier | -20 V to +20 V typ. | |
| DC offset accuracy | | |
| \pm 5 V voltage window | \pm (25 mV + 1%) | \pm (25 mV + 1%) |
| \pm 10 V voltage window | \pm (50 mV + 1%) | \pm (50 mV + 1%) |
| \pm 20 V voltage window | \pm (75 mV + 1%) | |
| Resolution | 1 mV, 4 digits | 1 mV, 4 digits |
| Output impedance | Selectable 50 Ω / 5 Ω typ. | 50 Ω nom. |
| Variable load impedance | 0.3 Ω to 1 M Ω ⁽³⁾ | 0.1 Ω to 1 M Ω |
| Protection | Short-circuit protected, overload disables main output | Short-circuit protected, overload disables main output |
| Connector | BNC, front panel | BNC, front panel |

1) All amplitudes are single-ended amplitudes. Differential peak-peak amplitudes are twice the single-ended value.

2) 10 VPP for 50 Ω into open; 9 VPP for 5 Ω into 50 Ω .

3) Current of normal Out plus current of complement Out is limited to 440 mA per channel.

4) Only for 50 Ω into open.

Clock Reference

External reference output

| | 81150A | 81160A |
|---------------------|-----------------------|-----------------------|
| Frequency | 10 MHz typ. | 10 MHz spec. |
| Accuracy | ± 50 ppm | ± 10 ppm |
| Stability | ± 2 ppm, 0 to 50 °C | ± 2 ppm, 0 to 55 °C |
| Aging | ± 1 ppm per year | ± 1 ppm per year |
| Output level | 1 V nom. | 1 V nom. |
| Impedance | 50 Ω nom., AC coupled | 50 Ω nom., AC coupled |
| Connector | BNC, rear panel | BNC, rear panel |

External reference input

| | 81150A | 81160A |
|--------------------|---|--|
| Lock range | 10 MHz ± 500 ppm | 10 MHz ± 500 ppm typ. |
| Input level | 200 mV _{pp} to 5 V _{pp} | 200 mV _{pp} to 5 V _{pp} typ. |
| Impedance | 1 kΩ nom., AC coupled | 1 kΩ nom., AC coupled |
| Connector | BNC, rear panel | BNC, rear panel |

Internal frequency characteristics

| | 81150A | 81160A |
|------------------|---------------------|---------------------|
| Accuracy | ± 50 ppm | ± 10 ppm |
| Stability | ± 2 ppm, 0 to 50 °C | ± 2 ppm, 0 to 55 °C |
| Aging | ± 1 ppm per year | ± 1 ppm per year |

External Input

A common external input is provided for both channels on the front panel. The external input is used for external trigger or external gate modes.

| | 81150A | 81160A |
|--------------------------------|------------------------------------|---|
| Frequency range | DC to 120 MHz | DC to 330 MHz |
| Input range | -10 V to +10 V | - 5 V to + 5 V |
| Maximum input amplitude | 10 V _{pp} | 10 V _{pp} |
| Input sensitivity | 200 mV _{pp} | Hysteresis low: 200 mV _{pp} Hysteresis high: 350 mV _{pp} |
| Threshold | | |
| Range | -10 V to 10 V | - 5 V to + 5 V |
| Resolution | 100 mV | 100 mV |
| Impedance | Selectable 10 kΩ /50 Ω, DC coupled | Selectable, 1 kΩ/ 50 Ω, DC coupled |
| Slope | Selectable, rising/falling/both | Selectable, rising/falling/both |
| Pulse width | > 3.3 ns | > 1.3 ns |
| Transition time | < 100 ns | |
| Connector | BNC, front panel | BNC, front panel |

Frequency counter

The frequency applied to external input is measured

| | | |
|---------------------------------|---|------------------------------------|
| Gate time, up to 330 MHz | — | 1 s, fix |
| Accuracy | — | See clock reference specifications |

81150A Trigger Outputs

For 81150A, a separate trigger output is provided for each channel on the front-panel.

In advanced mode internally/externally modulated (AM, FM, PM, PWM), the trigger output has the frequency of the unmodulated carrier waveform, with a 50% duty cycle.

For FSK modulation, the trigger output has the same frequency as the data output. That is, it alternates between the two frequencies.

If noise is selected, a trigger signal is generated when noise is restarted internally, externally or manually.

For all other modes of operation the trigger signal (TRIGGER OUT) marks the start of each waveform period.

81150A Trigger Out 1/Trigger Out 2

| 81150A | |
|-------------------------------------|-----------------------|
| Output level | Selectable TTL/ECL |
| TTL | 0 V / 2.5 V nom. |
| ECL | -0.85 V/-1.80 V nom. |
| Pulse width | |
| Internally triggered, continuous | 50% duty cycle typ. |
| Externally triggered | 4 ns typ. |
| Transition time (20% to 80%) | 2.0 ns typ. |
| Maximum rate | 120 MHz ¹⁾ |
| Impedance | 50 Ω nom. |
| Connector | BNC, front panel |

1) For output frequencies > 120 MHz, the trigger rate is ¼ of the output frequency. If a frequency sweep or a FSK frequency exceeds 120 MHz, the trigger rate is ¼ of the output frequency.

81150A Strobe Outputs

A strobe output is provided for each channel on the front-panel of pulse generator 81150A. The strobe output signal has a different function, depending on the mode of operation.

If no advanced mode is selected, the strobe output is a constant low.

In advanced mode internal/external triggered or gated burst, the strobe output provides a signal indicating the duration of a burst. The rising edge of the strobe signal is synchronized to the start of the first waveform period in a burst. The falling edge is synchronized to the start of the last waveform period in the burst.

In advanced mode sweep with the frequency marker off, the strobe output is a pulse with half the duration of the sweep. The strobe signal goes high at the beginning of the sweep.

In advanced mode sweep with the frequency marker on, the strobe output goes high at the beginning of the sweep and goes low at the marker frequency.

In pattern mode (block mode = On), the strobe output goes high at the beginning of the pattern and goes low at the last bit of the pattern. Refer to the User Guide for more details.

In advanced mode internally/externally modulated (AM, FM, FSK, PM, PWM), the strobe output is the analog modulation waveform.

In pattern mode (block mode = On), the logical strobe signal goes high at the beginning of the pattern and goes low at the last bit of the pattern. Refer to the User Guide for more details.

81150A Strobe Out 1/Strobe Out 2

| 81150A | |
|-------------------------------------|------------------------------|
| Digital output level | Selectable TTL/ECL |
| TTL | 0 V/2.5 V nom. |
| ECL | -0.85 V/-1.80 V nom. |
| Analog output level (modulator) | -2.0 V to 2.0 V (full scale) |
| Impedance | 50 Ω nom. |
| Connector | BNC, front panel |
| Min pulse width | 4 ns typ. |
| Transition time (20% to 80%) | 2.0 ns typ. |

81160A Trigger and Strobe Outputs Sync Out A and Sync Out B

For the one channel instrument as well as the two channel instrument two high speed outputs Sync Out A and Sync Out B are provided at the front panel. The Sync output signals can be configured very flexible by an internal switch matrix to output the logical Trigger Out functionality or Strobe Out functionality according to the following switch matrix.

1 channel instrument

| | 81160A |
|--------------------------|---|
| Sync Out A source | None, logical trigger signal 1, logical strobe signal 1 |
| Sync Out B source | None, logical trigger signal 1, logical strobe signal 1 |

1) It is e.g. possible, that the logical trigger signal 1 functionality is routed simultaneously to Sync Out A and Sync Out B.

2 channel instrument

| | 81160A |
|--------------------------|--|
| Sync Out A source | None, logical trigger signal 1, logical strobe signal 1, logical trigger signal 2, logical strobe signal 2 |
| Sync Out B source | None, logical trigger signal 1, logical strobe signal 1, logical trigger signal 2, logical strobe signal 2 |

1) It is e.g. possible, that the logical trigger signal 1 functionality is routed simultaneously to Sync Out A and Sync Out B.

Sync Out A/Sync Out B

| | 81160A |
|---------------------------------|---|
| Digital output level | Selectable TTL, ECL |
| TTL | 0 V/2.5 V nom. |
| ECL | -0.85 V/-1.80 V nom. |
| Analog output level (modulator) | -2.0 V to 2.0 V (full scale), Available, if routed to logical Strobe Out |
| Impedance | 50 Ω nom. |
| Transition time | 0.8 ns typ. (20%/80%) |
| Connector | BNC, front panel |

The logical trigger output and logical strobe output functionality is described below.

Logical trigger signal

The logical trigger signal is an internally generated signal that can be routed to the BNC connector of Sync Out A or Sync Out B. For the two channel instrument, the logical trigger signal is generated for both, channel 1 and channel 2.

In advanced mode internally/externally modulated (AM, FM, PM, PWM), the logical trigger signal has the frequency of the unmodulated carrier waveform with 50% duty cycle.

For FSK modulation the logical trigger signal generates the same frequency as the data output – it alternates between the two frequencies.

If noise is selected, a trigger signal is generated when noise is restarted internally, externally or manually.

For all other modes of operation the logical trigger signal marks the start of each waveform period.

Logical trigger signal 1/logical trigger signal 2

| 81160A | |
|----------------------------------|------------------------|
| Pulse width | |
| Internally triggered, continuous | 50% duty cycle typ. |
| Externally triggered | 1.5 ns typ. |
| Maximum rate | 330 MHz ⁽¹⁾ |

1) For output frequencies > 330 MHz, the trigger rate is ½ of the output frequency. In pattern mode with bit rate > 330 MBit/s, the trigger rate is ½ of the output frequency. If a frequency sweep or a FSK frequency exceeds 330 MHz, the trigger rate is ½ of the output frequency.

Logical strobe signal

The logical strobe signal is an internally generated signal that can be routed to the BNC connector of Sync Out A or Sync Out B. For the two channel instrument, the logical strobe signal is generated for both, channel 1 and channel 2.

The logical strobe signal has a different function, depending on the mode of operation. If no advanced mode is selected, the logical strobe signal is constant low.

In advanced mode internal/external triggered or gated burst, the logical strobe signal provides a signal indicating the duration of a burst. The rising edge of the logical strobe signal is synchronized to the start of the first waveform period in a burst. The falling edge is synchronized to the start of the last waveform period in the burst.

In advanced mode sweep with the frequency marker off, the logical strobe signal is a pulse with half of the duration of the sweep. The strobe signal goes high at the beginning of the sweep.

In advanced mode sweep with the frequency marker on, the logical strobe signal goes high at the beginning of the sweep and goes low at the marker frequency.

In advanced mode internally/externally modulated (AM, FM, FSK, PM, PWM), logical strobe signal is the analog modulation waveform.

In pattern mode (block mode=On), the logical strobe signal goes high at the beginning of the pattern and goes low at the last bit of the pattern. Refer to the User Guide for more details.

Digital Channel Addition

If the instrument is equipped with two output channels, channel 2 can be added to channel 1 internally. The maximum output voltage of channel 1 remains unchanged. If channel addition is selected, channel 2 outputs the unchanged waveform of channel 2.

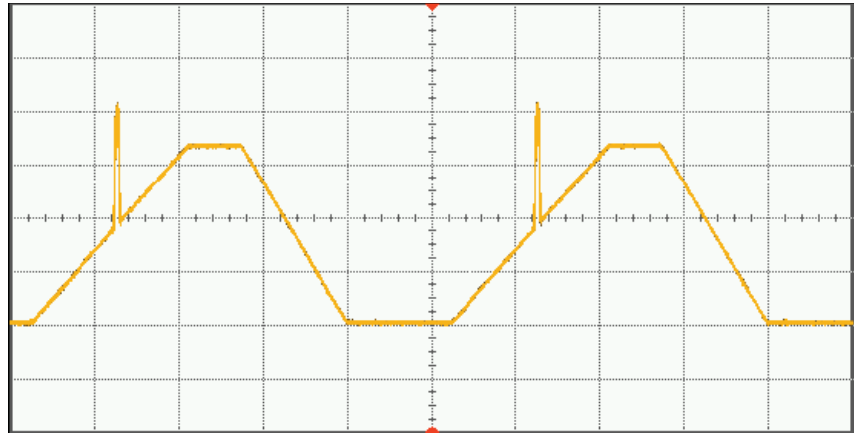

Timing Characteristics

External In timing characteristics

| | 81150A | 81160A |
|--|--|--|
| Delay: External In to Main Out 1, 2 | | |
| Fix delay | | |
| Advance mode: off, burst | 366 ns typ. | 404 ns typ. |
| Advanced mode: sweep | 350 ns typ. | 404 ns typ. |
| Pattern mode: on | | |
| Variable delay ⁽¹⁾ | 406 ns typ. | 404 ns typ. |
| Range | Independent for Out 1, Out 2 0 s to 1000 s ⁽²⁾ | Independent for Out 1, Out 2 0 s to 1000 s ⁽²⁾ |
| Resolution | 1 ps, 6 digits | 1 ps, 6 digits |
| Accuracy | ± 25 ps ± 50 ppm | ± 35 ps ± 50 ppm |
| Delay | | |
| | External In to Trigger Out 1, 2 | External In to Sync Out A, B |
| Fix delay | | |
| Advanced mode: off, burst | 366 ns typ. | 404 ns typ. |
| Advanced mode: sweep | 350 ns typ. | 404 ns typ. |
| Pattern mode: on | 406 ns typ. | 404 ns typ. |
| Jitter⁽³⁾ | | |
| External In to Main Out 1, 2 | 15 ps RMS typ. | 15 ps RMS typ. |
| External In to Trigger Out 1, 2 | 15 ps RMS typ. | — |
| External In to Strobe Out 1, 2 | 15 ps RMS typ. | — |
| External In to Sync Out A, B | — | 15 ps RMS typ. |

1) Not available, if sweep or modulation is selected

2) Trigger period ≥ variable delay

3) External in amplitude > 500 mV. External in transition time < 10 ns. Valid for externally triggered pulse, square, sine, ramp, arb. Externally triggered noise or externally triggered sweep has peak-peak jitter of 8 ns for the 81150A and 3.2 ns for the 81160A, measured with 50 Ω source impedance at main output.

Continuous or internally triggered timing characteristics

| | 81150A | 81160A |
|---|---|---|
| Delay | Trigger Out 1, 2 to Main Out 1, 2 | Sync Out A, B to Main Out 1,2 |
| Fix delay | 0 ns typ. | 0 ns typ. |
| Variable delay Out 1, 2 ⁽¹⁾ | Independent for Out 1, Out 2 | Independent for Out 1, Out 2 |
| Range in continuous mode ⁽²⁾ | 0 to 1 waveform period | 0 to 1 waveform period |
| Range in internally triggered mode ⁽³⁾ | 0 s to 1000 s typ. | 0 s to 1000 s spec. |
| Resolution | 1 ps, 6 digits | 1 ps, 6 digits |
| Accuracy | ± 25 ps ± 50 ppm | ± 35 ps ± 50 ppm |
| Delay | Trigger Out 1, 2 to Strobe Out 1, 2 | Sync Out A to Sync Out B |
| Advanced mode: burst | 0 ns typ. | 0 ns typ. |
| Jitter⁽⁴⁾ | Jitter | Jitter |
| | Main Out 1, 2 to Main Out 1, 2: 7 ps RMS typ. | Main Out 1, 2 to Main Out 1, 2: 7 ps RMS typ. |
| | Trigger Out 1, 2 to Main Out 1, 2: 8 ps RMS typ. | Sync Out A, B to Main Out 1, 2: 8 ps RMS typ. |
| | Trigger Out 1, 2 to Strobe Out 1, 2: 9 ps RMS typ. | Sync Out A to Sync Out B: 9 ps RMS typ. |
| | Trigger Out 1, 2 to Trigger Out 1, 2: 9 ps RMS typ. | |

1) Not available, if sweep or modulation is selected.

2) Advanced mode = off or advanced mode = burst .

3) Trigger period ≥ variable delay.

4) Measured with 50 Ω source impedance at Main Out. Valid for continuous or internally triggered pulse, square, sine, ramp, arb.
Internally triggered or continuous noise or sweep has peak-peak jitter of 8 ns typ. for the 81150A and 3.2 ns for the 81160A.

Coupled mode on timing characteristics

| | 81150A | 81160A |
|---|------------------------------|------------------------------|
| Delay: Main Out 1 to Main Out 2 | | |
| Fix delay | 0 ns typ. | 0 ns typ. |
| Variable delay Out 1, 2 ⁽¹⁾ | Independent for Out 1, Out 2 | Independent for Out 1, Out 2 |
| Range in continuous mode ⁽²⁾ | 0 to 1 waveform period | 0 to 1 waveform period |
| Range in internally triggered mode ⁽³⁾ | 0 s to 1000 s typ. | 0 s to 1000 s spec. |
| Resolution | 1 ps, 6 digits | 1 ps, 6 digits |
| Accuracy | ± 25 ps ± 50 ppm | ± 35 ps ± 50 ppm |

1) Not available, if sweep or modulation is selected.

2) Advanced mode = off or advanced mode = burst .

3) Trigger period ≥ variable delay.

Pattern generator (optional)

| | 81150A Option PAT | 81160A Option 330 | 81160A Option 660 |
|----------------------------------|---|--|--|
| Data rate | 1 μ bit/s to 120 Mbit/s (with internal pattern source) | 1 μ bit/s to 330 Mbit/s | 1 μ bit/s to 660 Mbit/s |
| Pattern memory | 16 Mbit with 1 bit resolution | 4 Mbit for 1 channel instrument 2 Mbit per channel for 2 channel instrument | |
| Pattern memory resolution | | 1 bit | 1 bit for data rate 1 μ bit/s to 330 Mbit/s 2 bits for data rate 330 Mbit/s to 660 Mbit/s |
| Number of levels | 2, 3, or 4 (user selectable) | | |
| Sequencing | Preamble followed by one looped data block—loop count: 1 - 10,000,000 the whole sequence can loop indefinitely or triggered | | |
| Trigger modes | Continuous, gated, one bit per trigger event, one sequence per trigger event | | |
| Pattern sources | Internal: PRBS -7, 9, 11, 15, 23, and 31 User-defined External: Pass through pattern mode. Pattern is applied and sampled at Modulation In. Indefinite pattern length. Up to 10 Mbit/s. Selectable automatic sampling for asynchronous operation or fixes sampling for synchronous operation | | |
| External sampling | Automatic and fix | | |
| Pattern modulation | AM, FM, PM | | |
| Arbitrary bit shapes | User defined and predefined bit transitions with up to 64 arbitrary waveform points per bit transitions | | |

Download Times

Block transfer is the fastest way to download waveforms to both the Agilent 81150A and 81160A Pulse Function Arbitrary Noise Generators. This is the type of download the 81150A IntuiLink Waveform Editor and the 81150A IVI-COM driver use.

Download times: block transfer (meas.)

| | 81150A | | | 81160A | | |
|--------------|-------------|-------------|-------------|-------------|-------------|-------------|
| | USB 2.0 | GPIO | LAN | USB 2.0 | GPIO | LAN |
| 1 k points | 31 ms typ. | 35 ms typ. | 35 ms typ. | 23 ms typ. | 44 ms typ. | 27 ms typ. |
| 8 k points | 65 ms typ. | 120 ms typ. | 80 ms typ. | 68 ms typ. | 198 ms typ. | 86 ms typ. |
| 64 k points | 700 ms typ. | 1 s typ. | 730 ms typ. | 330 ms typ. | 1.36 s typ. | 449 ms typ. |
| 256 k points | | | | 1.25 s typ. | 5.4 s typ. | 1.75 s typ. |
| 512 k points | 2.9 s typ. | 5.2 s typ. | 3.7 s typ. | | | |

Download times: integer comma separated values (meas.)

| | 81150A | | | 81160A | | |
|-------------|-------------|-------------|-------------|-------------|-------------|-------------|
| | USB 2.0 | GPIO | LAN | USB 2.0 | GPIO | LAN |
| 1 k points | 220 ms typ. | 200 ms typ. | 220 ms typ. | 214 ms typ. | 188 ms typ. | 181 ms typ. |
| 8 k points | 1.8 s typ. | 1.6 s typ. | 1.4 s typ. | 1.6 s typ. | 1.45 s typ. | 1.39 s typ. |
| 64 k points | 14.2 s typ. | 12.6 s typ. | 12 s typ. | 13.0 s typ. | 11.5 s typ. | 11.0 s typ. |

Download times: float comma separated values (meas.)

| | 81150A | | | 81160A | | |
|-------------|-------------|-------------|-------------|-------------|-------------|-------------|
| | USB 2.0 | GPIO | LAN | USB 2.0 | GPIO | LAN |
| 1 k points | 290 ms typ. | 280 ms typ. | 270 ms typ. | 297 ms typ. | 256 ms typ. | 236 ms typ. |
| 8 k points | 2.4 s typ. | 2.1 s typ. | 1.9 s typ. | 2.23 s typ. | 1.98 s typ. | 1.8 s typ. |
| 64 k points | 20 s typ. | 16 s typ. | 15 s typ. | 18.2 s typ. | 15.7 s typ. | 14.3 s typ. |

IntuiLink Waveform for the 81150A Editor import file formats

| Software | Import file formats |
|---------------------------------------|---------------------|
| Microsoft® Excel | .xls .txt .prn .csv |
| Matlab | .mat .dat |
| ADS | .sdf .tim .spw |
| Pspice | .txt .out |
| DSO7000, MSO7000 Series | |
| DSO6000, MSO6000 Series | |
| 5000 Series | |
| Infiniium (8000, 80000, 548xx) Series | |
| 546xx Series | |

The Agilent 33503A BenchLink Waveform Builder Pro is being designed for waveform creation, waveform import from Agilent scopes and waveform download to the 81150A and 81160A. Please refer to the User Guide and to the Data Sheet of the Benchlink Waveform Builder Pro Software to get the latest list of supported file formats.

General Specifications

| | 81150A | 81160A |
|------------------------------|--|--|
| Power supply | 100 V to 240 V ~, 50 to 60 Hz 100 V to 127 V ~, 50 to 400 Hz | 100 V to 240 V ~, 50 to 60 Hz 100 V to 127 V ~, 50 to 400 Hz |
| Power consumption | 110 W nom. | 90 W nom. |
| Operating temperature | 0 to 50 °C | 0 to 55 °C |
| Operating altitude | Up to 2000 m | Up to 2000 m |
| Storage temp. | -40 to 70 °C | -40 to 70 °C |
| Stored states | 4 named user configurations and factory default | 4 named user configurations and factory default |
| Power on state | Default or last state | Default or last state |
| Interface | 2 x USB 2.0 standard A, 1 x USB 2.0 standard B, GPIB and LAN | 2 x USB 2.0 standard A, 1 x USB 2.0 standard B, GPIB and LAN |
| Programming language | SCPI-1997 IEEE-488.2 LXI compliant to LXI class C (rev. 1.1) | SCPI-1997 IEEE-488.2 LXI compliant to LXI class C (rev. 1.1) |
| Dimensions (WxHxD) | | |
| Bench top | 439 mm x 108 mm x 456 mm | 439 mm x 108 mm x 456 mm |
| Rack mount | 428 mm x 89 mm x 439 mm | 428 mm x 89 mm x 439 mm |
| Weight | 8 kg | 8 kg |
| Safety designed to | IEC61010-1 UL61010 CSA22.2 61010.1 certified | IEC61010-1 UL61010 CSA22.2 61010.1 certified |
| EMC tested to | IEC61326 | IEC61326 |
| Warm up time | 30 min. | 30 min. |
| Calibration interval | 1 year recommended | 2 years recommended |
| Warranty | 1 year standard | 1 year standard |
| Cooling requirements | When operating the instrument choose a location that provides at least 80 mm of clearance at rear, and at least 30mm of clearance at each side | When operating the instrument choose a location that provides at least 80 mm of clearance at rear, and at least 30mm of clearance at each side |

Definitions

Specification (spec.)

The warranted performance of a calibrated instrument that has been stored for a minimum of 2 hours within the operating temperature range of 0 °C to 55 °C and after a 45-minute warm up period. Within ± 10 °C after autocal. All specifications include measurement uncertainty and were created in compliance with ISO-17025 and Z540 methods. Data published in this document are specifications (spec) only where specifically indicated.

Typical (typ.)

The characteristic performance, which 80% or more of manufactured instruments will meet. This data is not warranted, does not include measurement uncertainty, and is valid only at room temperature (approximately 23 °C).

Nominal (nom.)

The mean or average characteristic performance, or the value of an attribute that is determined by design such as a connector type, physical dimension, or operating speed. This data is not warranted and is measured at room temperature (approximately 23 °C).

Measured (meas.)

An attribute measured during development for purposes of communicating the expected performance. This data is not warranted and is measured at room temperature (approximately 23 °C).

Accuracy

Represents the traceable accuracy of a specified parameter. Includes measurement error and timebase error, and calibration source uncertainty.

Available Modes of Operation

Continuous

| | | 81150A and 81160A | | | | | | |
|----------------------------------|-----|-------------------|--------|------|------|-------|-----|----|
| | | Pulse | Square | Sine | Ramp | Noise | Arb | DC |
| Advanced mode: off | | Y | Y | Y | Y | Y | Y | Y |
| Advanced mode: burst | | Y | Y | Y | Y | N | Y | N |
| Advanced mode: Modulation | AM | N | Y | Y | Y | N | Y | N |
| | FM | N | Y | Y | Y | N | Y | N |
| | PM | N | Y | Y | Y | N | Y | N |
| | FSK | N | Y | Y | Y | N | Y | N |
| | PWM | Y | N | N | N | N | N | N |
| Advanced mode: sweep | | N | Y | Y | Y | N | Y | N |

Internally triggered or externally triggered

| | | 81150A and 81160A | | | | | | |
|----------------------------------|-----|-------------------|--------|------|------|-------|-----|----|
| | | Pulse | Square | Sine | Ramp | Noise | Arb | DC |
| Advanced mode: off | | Y | Y | Y | Y | Y | Y | N |
| Advanced mode: burst | | Y | Y | Y | Y | N | Y | N |
| Advanced mode: Modulation | AM | N | N | N | N | N | N | N |
| | FM | N | N | N | N | N | N | N |
| | PM | N | N | N | N | N | N | N |
| | FSK | N | N | N | N | N | N | N |
| | PWM | N | N | N | N | N | N | N |
| Advanced mode: sweep | | N | Y | Y | Y | N | Y | N |

Gated

| | | 81150A and 81160A | | | | | | |
|----------------------------------|-----|-------------------|--------|------|------|-------|-----|----|
| | | Pulse | Square | Sine | Ramp | Noise | Arb | DC |
| Advanced mode: off | | Y | Y | Y | Y | Y | Y | N |
| Advanced mode: burst | | Y | Y | Y | Y | N | Y | N |
| Advanced mode: Modulation | AM | N | N | N | N | N | N | N |
| | FM | N | N | N | N | N | N | N |
| | PM | N | N | N | N | N | N | N |
| | FSK | N | N | N | N | N | N | N |
| | PWM | N | N | N | N | N | N | N |
| Advanced mode: sweep | | N | Y | Y | Y | N | Y | N |

Ordering Information for

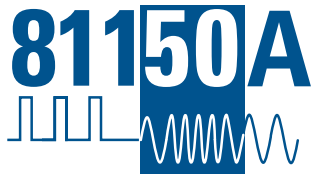

Agilent 81150A

| | |
|------|--|
| #001 | 1-channel pulse function arbitrary noise generator |
| #002 | 2-channel pulse function arbitrary noise generator |
| #1A7 | ISO17025 calibration documents |
| #Z54 | Z540.3 calibration documents |
| #PAT | License for 120 Mbit/s pattern generator |

Accessories included

- Certificate of calibration
- Local power cord
- USB cable
- Product CD (User Guide, Getting Started Guide, IVI-COM driver, examples for remote access)

Optional accessories

| | |
|---------|--|
| #DOC | Printed documentation. Includes printed Getting Started Guide and printed User Guide |
| #1CP | Rack mount kit |
| #R1280A | Additional 2-years warranty (3-years total) |

Upgrades for 81150A

81150AU

| | |
|------|--|
| #PAT | License for pattern generator |
| #DOC | Printed documentation |
| #EHD | Fixture for 100 Mbit Ethernet and HDMI 1.4 |

Ordering Information for

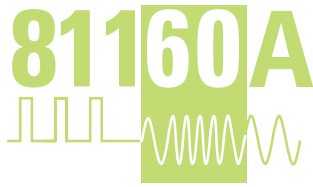

Agilent 81160A

| | |
|------|--|
| #001 | 1-channel pulse function arbitrary noise generator |
| #002 | 2-channel pulse function arbitrary noise generator |
| #1A7 | ISO17025 calibration documents |
| #Z54 | Z540.3 calibration documents |
| #330 | License for 330 Mbit/s pattern generator |
| #660 | License for 660 Mbit/s pattern generator |

Accessories included

- Certificate of calibration
- Local power cord
- USB cable
- Product CD (User Guide, Getting Started Guide, IVI-COM driver, examples for remote access)

Optional accessories

| | |
|---------|--|
| #DOC | Printed documentation. Includes printed Getting Started Guide and printed User Guide |
| #1CP | Rack mount kit |
| #R1280A | Additional 2-years warranty (3-years total) |

Upgrades for 81160A

| | |
|---------|---|
| 81160AU | |
| #330 | License for 330 Mbit/s pattern generator |
| #660 | License for 660 Mbit/s pattern generator |
| #326 | License for upgrade from 330 Mbit/s to 660 Mbit/s pattern generator |
| #DOC | Printed documentation |

| Literature title | Publication number |
|---|--------------------|
| <i>Pulse Pattern and Data Generators Brochure</i> | 5980-0489E |
| <i>81150A and 81160A Pulse Function Arbitrary Noise Generator Demo Guide</i> | 5989-7718EN |
| <i>81150A Pulse Function Arbitrary Noise Generator Flyer</i> | 5989-7720EN |
| <i>81150A and 81160A Pulse Function Arbitrary Noise Generator Application Booklet</i> | 5989-7860EN |
| <i>81150A Quick Fact Sheet</i> | 5990-4565EN |
| <i>81160A Quick Fact Sheet</i> | 5990-6984EN |

For the latest version of this document, please visit our website at:
www.agilent.com/find/81150
www.agilent.com/find/81160
 and go to the Product Library.



www.lxistandard.org

LAN eXtensions for Instruments puts the power of Ethernet and the Web inside your test systems. Agilent is a founding member of the LXI consortium.



Agilent Advantage Services is committed to your success throughout your equipment's lifetime. We share measurement and service expertise to help you create the products that change our world. To keep you competitive, we continually invest in tools and processes that speed up calibration and repair, reduce your cost of ownership, and move us ahead of your development curve.

www.agilent.com/find/advantageservices



www.agilent.com/quality

Agilent Channel Partners

www.agilent.com/find/channelpartners

Get the best of both worlds: Agilent's measurement expertise and product breadth, combined with channel partner convenience.



Agilent Email Updates

www.agilent.com/find/emailupdates

Get the latest information on the products and applications you select.

Microsoft is either a registered trademark or a trademark of Microsoft Corporation in the United States and/or other countries.

www.agilent.com

www.agilent.com/find/81150

www.agilent.com/find/81160

For more information on Agilent Technologies' products, applications or services, please contact your local Agilent office. The complete list is available at:

www.agilent.com/find/contactus

Americas

| | |
|---------------|----------------|
| Canada | (877) 894 4414 |
| Brazil | (11) 4197 3500 |
| Mexico | 01800 5064 800 |
| United States | (800) 829 4444 |

Asia Pacific

| | |
|--------------------|----------------|
| Australia | 1 800 629 485 |
| China | 800 810 0189 |
| Hong Kong | 800 938 693 |
| India | 1 800 112 929 |
| Japan | 0120 (421) 345 |
| Korea | 080 769 0800 |
| Malaysia | 1 800 888 848 |
| Singapore | 1 800 375 8100 |
| Taiwan | 0800 047 866 |
| Other AP Countries | (65) 375 8100 |

Europe & Middle East

| | |
|----------------|----------------------|
| Belgium | 32 (0) 2 404 93 40 |
| Denmark | 45 70 13 15 15 |
| Finland | 358 (0) 10 855 2100 |
| France | 0825 010 700* |
| | *0.125 €/minute |
| Germany | 49 (0) 7031 464 6333 |
| Ireland | 1890 924 204 |
| Israel | 972-3-9288-504/544 |
| Italy | 39 02 92 60 8484 |
| Netherlands | 31 (0) 20 547 2111 |
| Spain | 34 (91) 631 3300 |
| Sweden | 0200-88 22 55 |
| United Kingdom | 44 (0) 118 9276201 |

For other unlisted Countries:

www.agilent.com/find/contactus

Revised: October 14, 2010

Product specifications and descriptions in this document subject to change without notice.

© Agilent Technologies, Inc. 2011
 Printed in USA, April 29, 2011
 5989-6433EN



Agilent Technologies