

# 714B TC Calibrator

## Quick Reference Guide

### ⚠️ Warning

To prevent possible electrical shock, fire, or personal injury, read the "714B Safety Sheet" before you use this Product.

Go to [www.fluke.com](http://www.fluke.com) to register your product, download manuals, and find more information.

### Magnetic Hanger

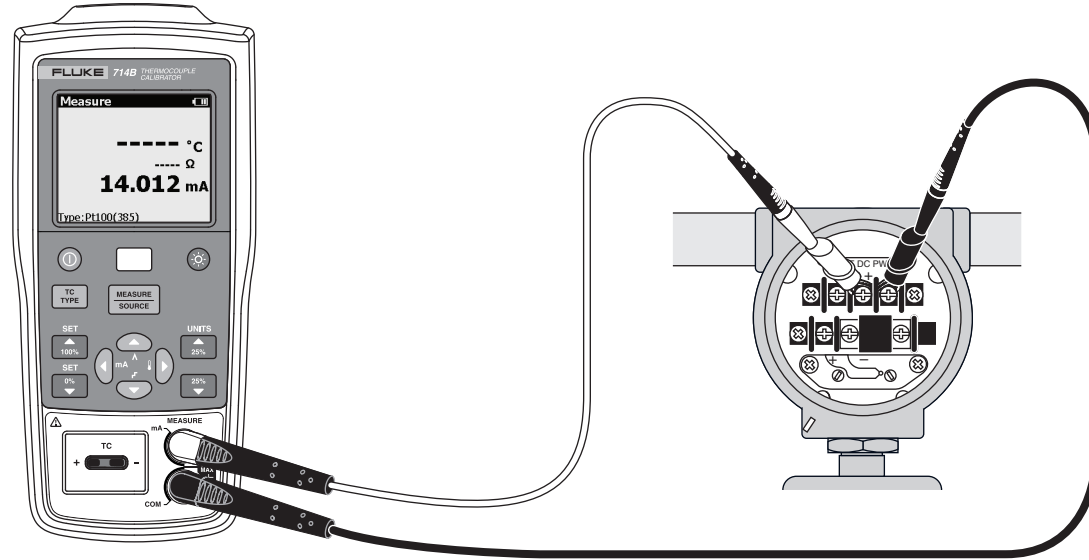
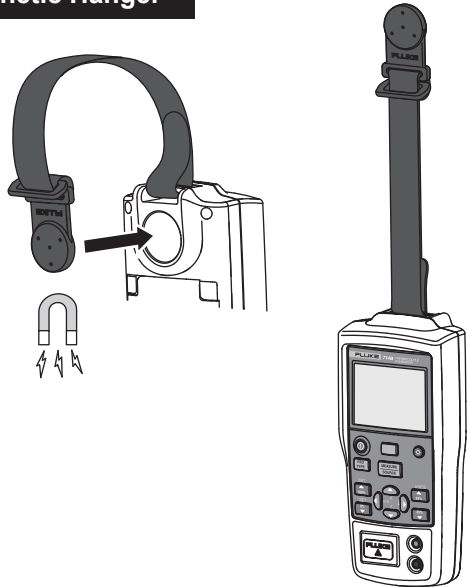

### TC Type

1. [TC TYPE]
2. [Up] [Down]
3. [TC TYPE]

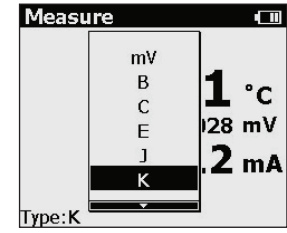

### Settings

1. [SHIFT]
2. [TC TYPE]
3. [Up] [Down]
4. [Right] Enable/Disable
5. [TC TYPE]

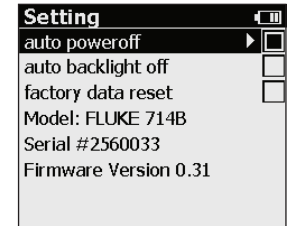

### TC Measure

### Temperature with TC

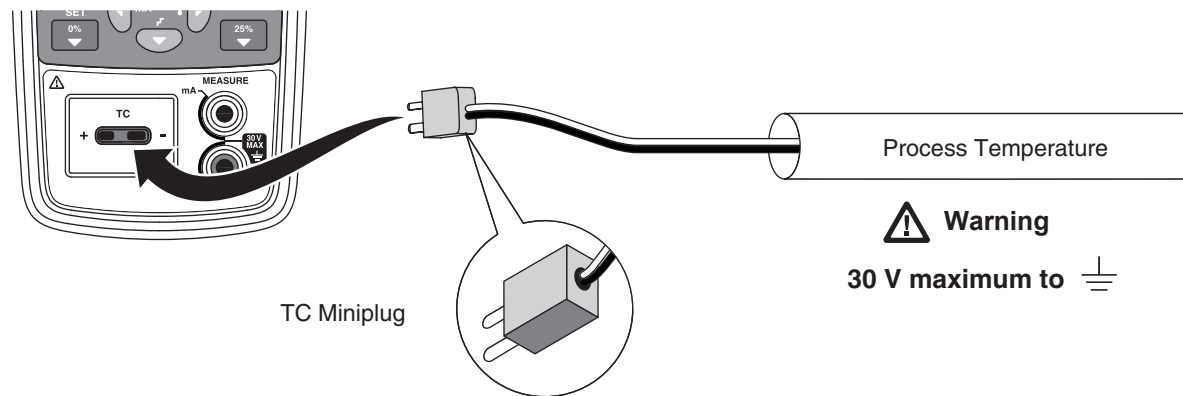

**⚠️ Warning**  
30 V maximum to

### Units

1. [SHIFT]
2. [UNITS] [Up]

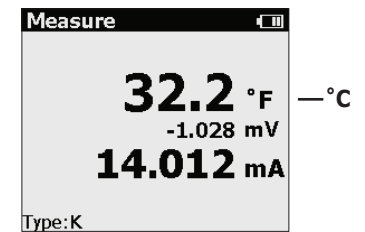

Source

Simulate Thermocouple

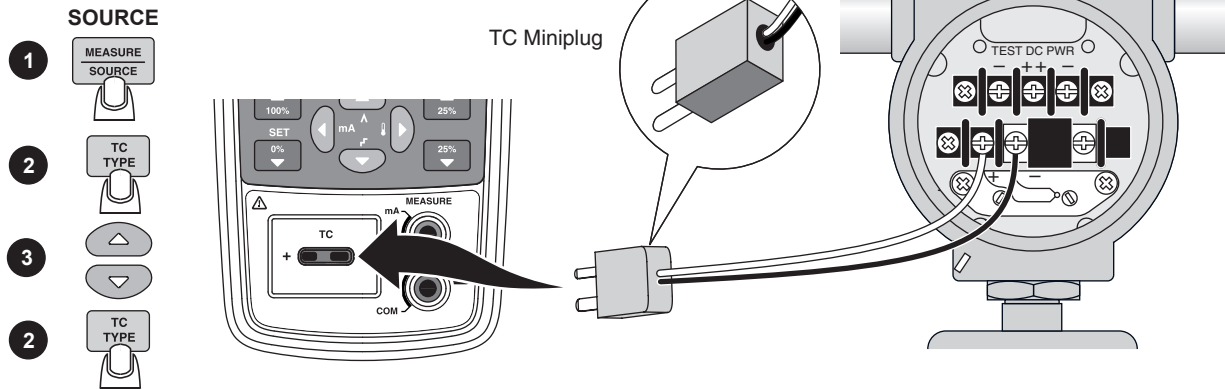

Set TC Value

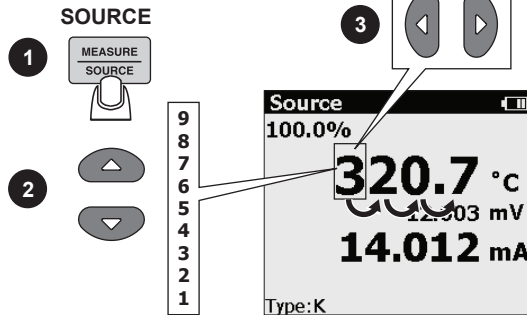

Contrast

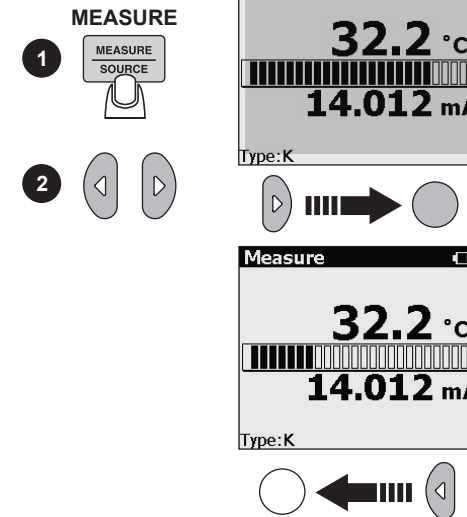

0%

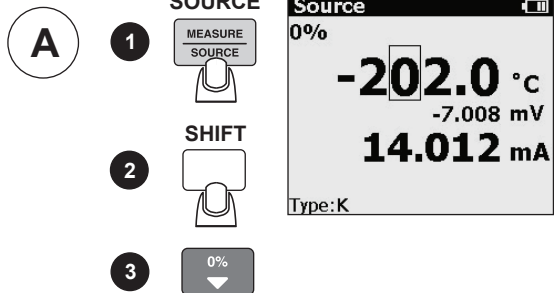

Linearity or Span Test

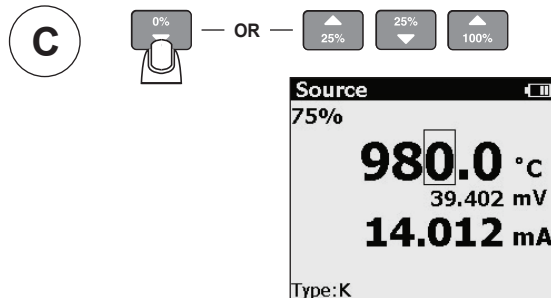

mA / °C Scale mA Channel to Temperature

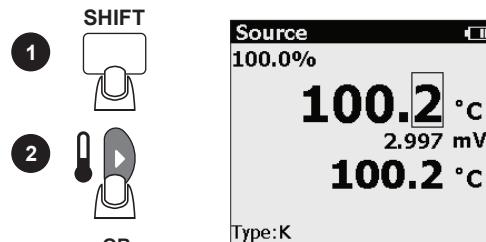

Note:

- Temperature at 4 mA =
- Span check 0 %
- Temperature at 20 mA =
- Span check 100 %

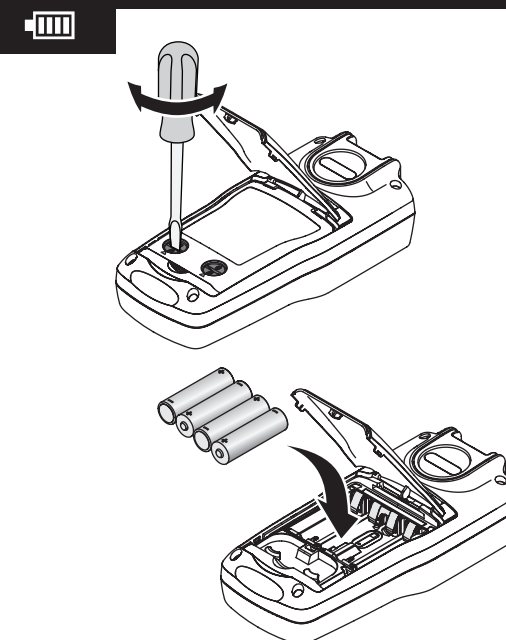

100%

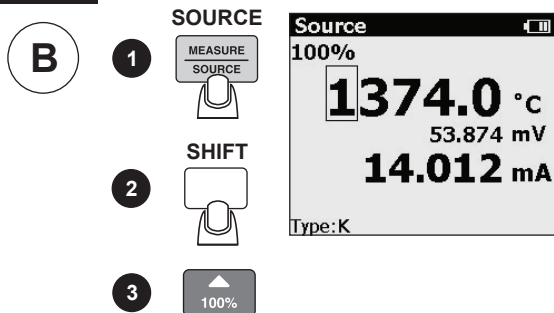

Ramp or Step

