

Agilent 4395A Network/Spectrum/Impedance Analyzer

Data Sheet

Network Measurement

Specifications describe the instrument's warranted performance over the temperature range of 0 °C to 40 °C (except as noted). Supplemental characteristics are intended to provide information that is useful in applying the instrument by giving non-warranted performance parameters. These are denoted as *SPC* (supplemental performance characteristics), *typical*, or *nominal*. Warm up time must be greater than or equal to 30 minutes after power on for all specifications.

Source characteristics

Frequency characteristics (Option 4395A-800)

Range 10 Hz to 500 MHz
Resolution 1 mHz

Frequency reference

Accuracy
 at 23 °C ± 5 °C, referenced to 23 °C < ±5.5 ppm
Aging < ±2.5 ppm/year (SPC)
Initial achievable accuracy < ± 1.0 ppm (SPC)
Temperature stability
 at 23 °C ± 5 °C, referenced to 23 °C < ±2 ppm (SPC)

Precision frequency reference (Option 4395A-1D5)

Accuracy
 at 0 °C to 40 °C, referenced to 23 °C < ±0.13 ppm
Aging < ±0.1 ppm/year (SPC)
Initial achievable accuracy < ±0.02 ppm (SPC)
Temperature stability
 at 0 °C to 40 °C, referenced to 23 °C < ±0.01 ppm (SPC)

Output characteristics

Power range -50 dBm to + 15 dBm
Level accuracy
 at 0 dBm output, 50 MHz, 23 °C ± 5 °C, ±1.0 dB

Level linearity

Output power	Linearity ¹
≥ -40 dBm	±1.0 dB
< -40 dBm	±1.5 dB

1. At relative to 0 dBm output, 50 MHz, 23 °C ± 5 °C

Network Measurement

continued

Flatness

at 0 dBm output, relative to 50 MHz, 23 °C ± 5 °C ±2 dB

Resolution 0.1 dB

Spectral purity characteristics

Harmonics

at +10 dBm output < -30 dBc

Non-harmonics spurious

at +10 dBm output < -30 dBc

Noise sidebands

at ≥ 10 kHz offset from carrier < -95 dBc/Hz

Power sweep range 20 dB max.

Power sweep linearity

deviation from linear power referenced to the stop power level ±0.5 dB

Impedance 50 Ω nominal

Return loss

frequency < 100 MHz > 12 dB (SPC)

frequency ≥ 100 MHz > 7 dB (SPC)

Connector Type N female

Receiver Characteristics

Input characteristics

Frequency range 10 Hz to 500 MHz

Input attenuator 0 to 50 dB, 10 dB step

Full scale input level (R, A, B)

Attenuator setting (dB)	Full scale input level
0	-10 dBm
10	0 dBm
20	+10 dBm
30	+20 dBm
40	+30 dBm
50	+30 dBm

IF bandwidth (IFBW) 2, 10, 30, 100, 300, 1 k, 3 k, 10 k, 30 kHz

Note: The IFBW should be set to less than 1/5 of the lowest frequency in the sweep range.

Noise level (referenced to full scale input level, 23 °C ± 5 °C)

at 10 Hz ≤ frequency < 100 Hz, IFBW = 2 Hz -85 dB (SPC)

at 100 Hz ≤ frequency < 100 kHz, IFBW = 10 Hz -85 dB

at 100 kHz ≤ frequency, IFBW = 10 Hz (-115 + f/100 MHz) dB

Input crosstalk

for input R + 10 dBm input, input attenuator: 20 dB

for input A, B input attenuator: 0 dB

at < 100 kHz

R through A, B < -100 dB

others < -100 dB (SPC)

at ≥ 100 kHz

R through A, B < -120 dB

others < -120 dB (SPC)

Source crosstalk (for input A, B)(typical for input R)

at + 10 dBm output, < 100 kHz, input attenuator: 0 dB < -100 dB

at + 10 dBm output, ≥100 kHz, input attenuator: 0 dB < -120 dB

Multiplexer switching impedance change

at input attenuator 0 dB < 0.5% (SPC)

at input attenuator 10 dB and above < 0.1% (SPC)

Connector Type-N female

Impedance 50 Ω nominal

Return loss

	Input attenuator		
	0 dB	10 dB	20 dB to 50 dB
10 Hz ≤ frequency < 100 kHz	25 dB ¹	25 dB ¹	25 dB ¹
100 kHz ≤ frequency ≤ 100 MHz	25 dB ¹	25 dB	25 dB ¹
100 MHz < frequency	15 dB ¹	15 dB	15 dB ¹

Maximum input level +30 dBm (at input attenuator: 40 dB or 50 dB)

Maximum safe input level +30 dBm or ±7 Vdc (SPC)

1. SPC

Magnitude Characteristics

Absolute amplitude accuracy (R, A, B)

at -10 dBm input, input attenuator:

10 dB, frequency ≥ 100 Hz, IFBW ≤ 3 kHz, $23\text{ }^\circ\text{C} \pm 5\text{ }^\circ\text{C}$, $< \pm 1.5$ dB

Ratio accuracy (A/R, B/R) (typical for A/B)

at -10 dBm input, input attenuator:

10 dB, IFBW ≤ 3 kHz, $23\text{ }^\circ\text{C} \pm 5\text{ }^\circ\text{C}$, $< \pm 2$ dB

Dynamic accuracy (A/R, B/R) (typical for A/B)

Input level (relative to full scale input level)	Dynamic accuracy ¹ frequency ≥ 100 Hz
0 dB \geq input level > -10 dB	± 0.4 dB
-10 dB \geq input level ≥ -60 dB	± 0.05 dB
-60 dB $>$ input level ≥ -80 dB	± 0.3 dB
-80 dB $>$ input level ≥ -100 dB	± 3 dB

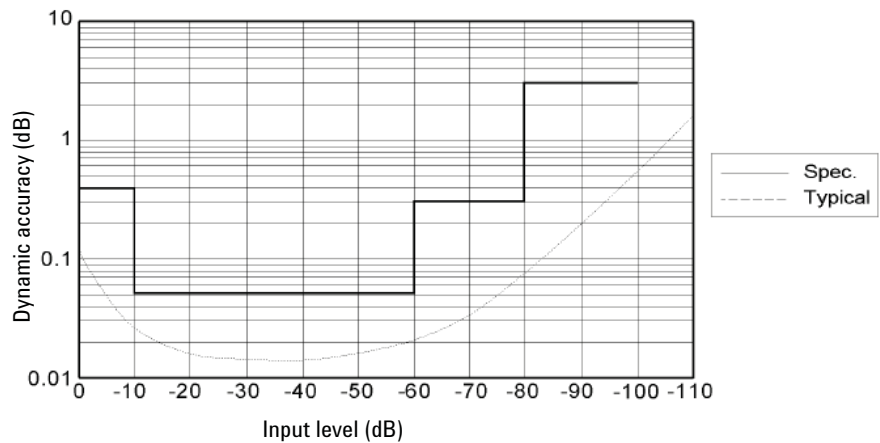

Figure 1-1. Magnitude dynamic accuracy

Residual responses < -80 dB full scale (SPC)

Trace noise (A/R, B/R, A/B)

at 50 MHz, both inputs:

full scale input level -10 dB, IFBW = 300 Hz. < 0.005 dB rms (SPC)

Stability (A/R, B/R, A/B) $< \pm 0.01$ dB/ $^\circ\text{C}$ (SPC)

Phase characteristics

Measurements format Standard format, expanded phase format

Frequency response (deviation from linear phase) (A/R, B/R) (SPC for A/B)

at -10 dBm input, input attenuator: 10 dB, IFBW ≤ 3 kHz, $23\text{ }^\circ\text{C} \pm 5\text{ }^\circ\text{C}$ $< \pm 12^\circ$

Dynamic accuracy (A/R, B/R) (SPC for A/B)

Input level (relative to full scale input level)	Dynamic accuracy ¹ frequency ≥ 100 Hz
0 dB \geq input level > -10 dB	$\pm 3^\circ$
-10 dB \geq input level ≥ -60 dB	$\pm 0.3^\circ$
-60 dB $>$ input level ≥ -80 dB	$\pm 1.8^\circ$
-80 dB $>$ input level ≥ -100 dB	$\pm 18^\circ$

1. R input level (B input level for A/B) = full scale input level -10 dB, IFBW = 10 Hz, $23\text{ }^\circ\text{C} \pm 5\text{ }^\circ\text{C}$

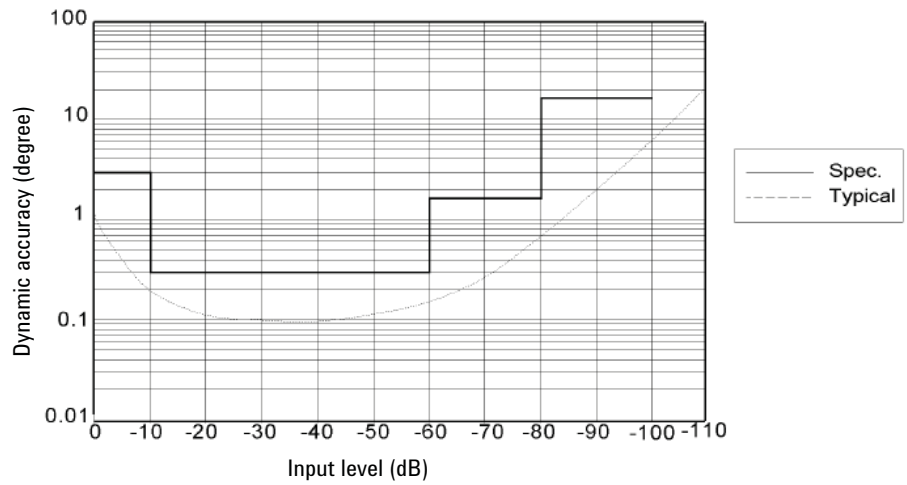

Figure 1-2. Phase dynamic accuracy

Trace noise (A/R, B/R, A/B)

at 50 MHz, both inputs:

full scale input level -10 dB, IFBW = 300 Hz. < 0.04° rms (SPC)

Stability (A/R, B/R, A/B) < ±0.1 °/°C (SPC)

Group delay characteristics

Aperture [Hz]. 0.25% to 20% of span

Accuracy

In general, the following formula can be used to determine the accuracy, in seconds, of a specific group delay measurement: $\frac{\text{Phase accuracy (degree)}}{\text{Aperture(Hz)} \times 360 \text{ (degree)}}$

Sweep characteristics

Sweep type Linear frequency, log frequency, power, list frequency

Sweep direction Upper direction only

Trigger type Hold, single, number of groups, continuous

Trigger source Internal (free run), external, manual, GPIB (bus)

Event trigger On point, on sweep

Spectrum Measurement

Frequency characteristics

Frequency range 10 Hz to 500 MHz

Frequency readout accuracy
 $\pm((freq\ readout[Hz]) \times (freq\ ref\ accuracy[1]) + RBW[Hz] + \frac{SPAN[Hz]}{NOP-1}) [Hz]$
 where NOP means number of display points

Frequency reference (Option 4395A-800)

Accuracy
 at 23 °C ± 5 °C, referenced to 23 °C < ±5.5 ppm

Aging < ±2.5 ppm/year (SPC)

Initial achievable accuracy < ± 1.0 ppm (SPC)

Temperature stability
 at 23 °C ± 5 °C, referenced to 23 °C < ±2 ppm (SPC)

Precision frequency reference (Option 4395A-1D5)

Accuracy
 at 0 °C to 40 °C, referenced to 23 °C < ±0.13 ppm

Aging < ±0.1 ppm/year (SPC)

Initial achievable accuracy < ±0.02 ppm (SPC)

Temperature stability
 at 0 °C to 40 °C, referenced to 23 °C < ±0.01 ppm (SPC)

Resolution bandwidth (RBW)

Range
 3 dB RBW at span > 0 1 Hz to 1 MHz, 1-3 step
 3 dB RBW at span = 0
 3 k, 5 k, 10 k, 20 k, 40 k, 100 k, 200 k, 400 k, 800 k, 1.5 M, 3 M, 5 MHz

Selectivity (60 dB BW/3 dB BW)
 at span > 0 < 3

Mode Auto or manual

Accuracy
 at span > 0 < ±10%
 at span = 0 < ±30%

Video bandwidth (VBW)

Range
 at span > 0 3 mHz to 3 MHz, 1-3 step, $0.003 \leq VBW/RBW \leq 1$

Noise sidebands

(Carrier Frequency: 10 MHz, 100 MHz, 500 MHz)

Offset from carrier	Noise sidebands
≥ 1 kHz	< -97 dBc/Hz
≥ 100 kHz	< -110 dBc/Hz

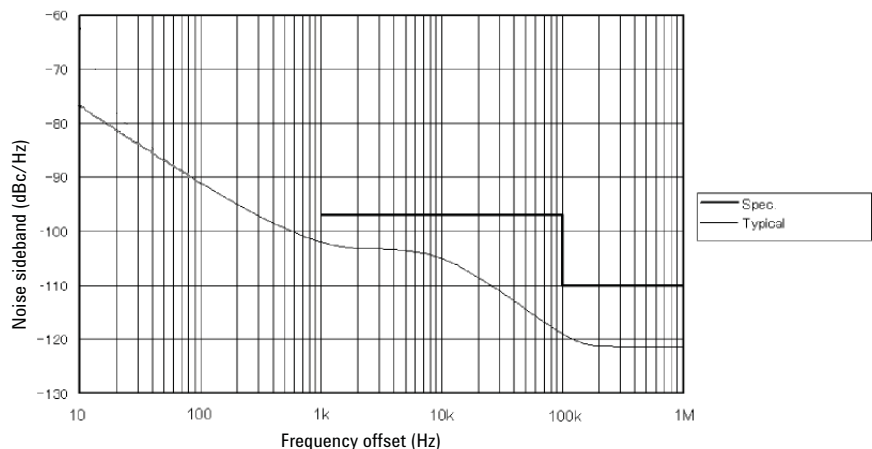

Figure 1-3. Noise sidebands

Amplitude Characteristics

Amplitude range displayed average noise level to +30 dBm

Reference value setting range -100 dBm to +30 dBm

Level accuracy

at -20 dBm input, 50 MHz, input attenuator: 10 dB, 23 °C ± 5 °C < ±0.8 dB

Frequency response

at -20 dBm input, input attenuator: 10 dB, referenced to level at 50 MHz, 23 °C ± 5 °C

frequency ≥ 100 Hz < ±1.3 dB

frequency < 100 Hz < ±3.0 dB

Amplitude fidelity¹

Log scale²

Range (dB to reference input level [dB])	Amplitude fidelity [dB]
0 to -30	±0.05
-30 to -40	±0.07
-40 to -50	±0.15
-50 to -60	±0.35
-60 to -70	±0.8
-70 to -80	±1.8

Linear scale² < ±3%

Displayed average noise level

at reference value ≤ -40 dBm, input attenuator: auto or 0 dB

at frequency ≥ 1 kHz -120 dBm/Hz

at ≥ 100 kHz -133 dBm/Hz

at ≥ 10 MHz (-145 + frequency/100 MHz) dBm/Hz³

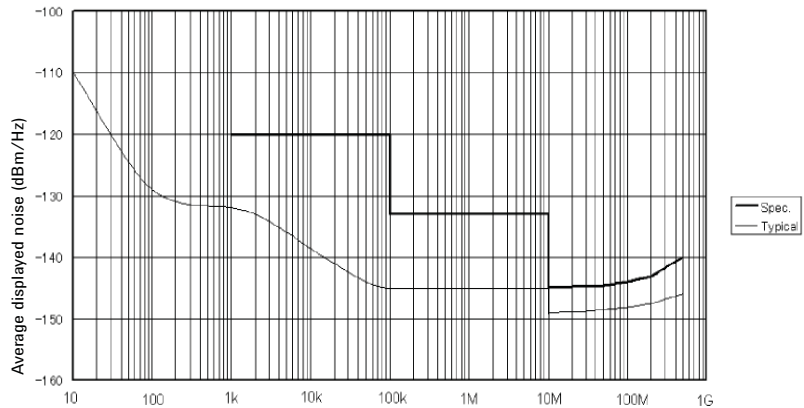

Figure 1-4. Typical displayed average noise level

1. Fidelity shows an extent of nonlinearity referenced to the reference input level.
2. RBW = 10 Hz, -20 dBm ≤ reference value ≤ +30 dBm, reference input level = full scale input level -10 dB, 23 ± 5 °C
3. At start frequency ≥ 10 MHz

Note: Refer to Input attenuator part for the definition of full scale input level.

On-screen Dynamic Range

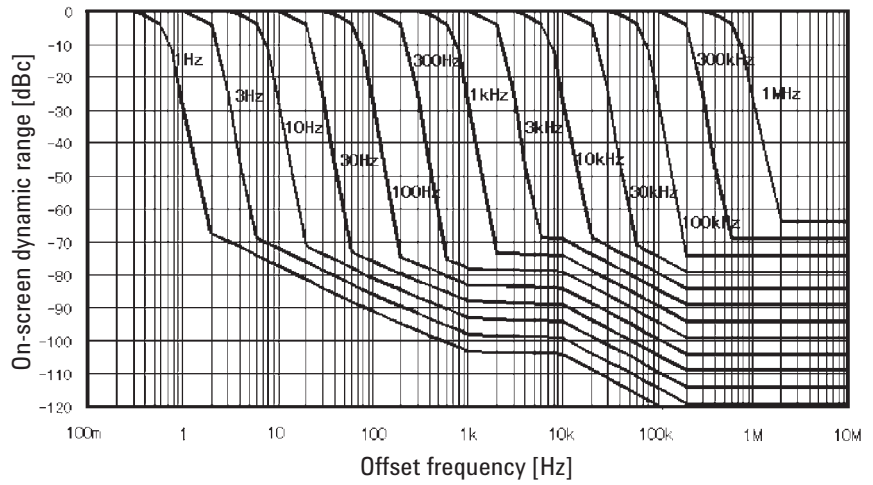

Figure 1-5. Typical on-screen dynamic range (center: 50 MHz)

Spurious responses

Second harmonic distortion

at single tone input with full scale input level -10 dB, input signal frequency ≥ 100 kHz
 < -70 dBc

Third order inter-modulation distortion

at two tones input with full scale input level -16 dB, separation ≥ 100 kHz
 < -70 dBc

Spurious

at single tone input with full scale input level -10 dB, input signal frequency ≤ 500 MHz
 (RBW ≤ 100 kHz, 1 kHz \leq frequency offset ≤ 300 MHz)
 < -70 dBc
 (≤ 60 dBc (SPC) if there are input signals in the following frequency range:
 (14.7 MHz to 15.9 MHz, 29.5 MHz to 31.7 MHz, 414.7 MHz to 415.9 MHz)

Residual response

at reference value setting ≤ -40 dBm, input attenuator: auto or 0 dB. < -108 dBm

Typical Dynamic Range

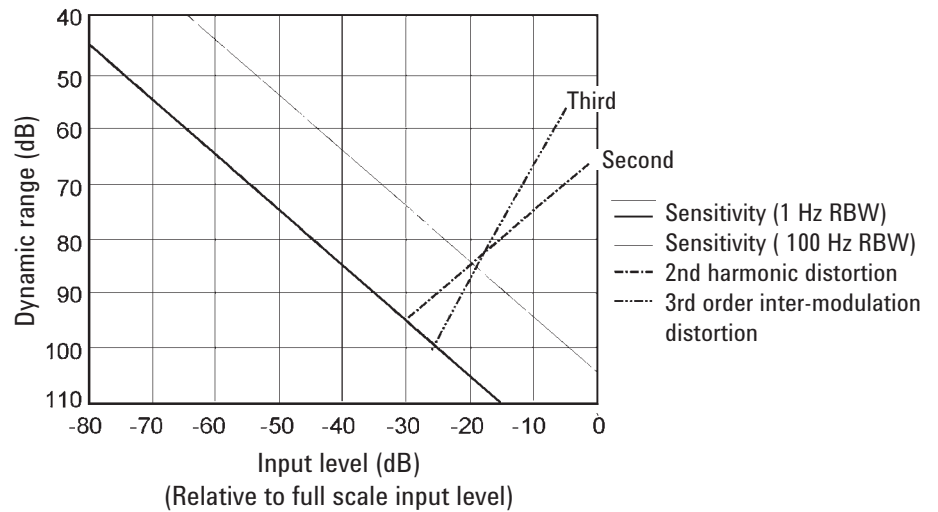

Figure 1-6. Typical dynamic range at inputs R, A, and B

Input attenuator

Setting range 0 dB to 50 dB, 10 dB step

Attenuator setting (dB)	Full scale input level
0	-20 dBm
10	-10 dBm
20	0 dBm
30	+10 dBm
40	+20 dBm
50	+30 dBm

Mode Auto or manual
(In auto mode, the attenuator is set to minimum value which ensures full scale input level \geq reference level.)

Input attenuator switching uncertainty

at attenuator: ≤ 30 dB, referenced to 10 dB $< \pm 1.0$ dB
at attenuator: ≥ 40 dB, referenced to 10 dB $< \pm 1.5$ dB

Temperature drift $< \pm 0.05$ dB/ $^{\circ}$ C (SPC)

Scale

Log 0.1 dB/div to 20 dB/div

Linear

at watt 1.0×10^{-12} W/div
at volt 1.0×10^{-9} V/div

Measurement format Spectrum or noise (/Hz)

Display unit dBm, dBV, dB μ V, V, W

Sweep characteristics

Sweep type Linear, list

Trigger type Hold, single, number of groups, continuous

Trigger source . Internal (free run), external, manual, level gate, edge gate, GPIB (bus)

Sweep time (excluding each sweep setup time)

RBW	SPAN	Typical sweep time
1 MHz	500 MHz	180 ms
100 kHz	100 MHz	300 ms
10 kHz	10 MHz	240 ms
1 kHz	1 MHz	190 ms
100 Hz	100 kHz	270 ms
10 Hz	10 kHz	2.0 s
1 Hz	1 kHz	11 s
—	Zero Span	— ¹

1. See the next item for sweep time at zero span

Zero span

RBW	Minimum resolution	Maximum sweep time
5 MHz	40 ns	1.28 ms
100 kHz	1.28 μ s	81.92 ms
3 kHz	40.96 μ s	2.62 s

Number of display points

at span > 0 2 to 801 points (automatically set)
 at span = 0 2 to 801 points (selectable)

Input characteristics

Input port R, A, B

Crosstalk

from any input to other inputs, at the same input attenuator settings < -100 dB (SPC)

Connector Type N female

Impedance 50 Ω nominal

Return loss

	Input attenuator		
	0 dB	10 dB	20 dB to 50 dB
10 Hz \leq frequency < 100 kHz	25 dB ¹	25 dB ¹	25 dB ¹
100 kHz \leq frequency \leq 100 MHz	25 dB ¹	25 dB	25 dB ¹
100 MHz < frequency	15 dB ¹	15 dB	15 dB ¹

Input level +30 dBm max. at input attenuator: 50 dB

Maximum safe input level +30 dBm or ± 7 Vdc (SPC)

Specifications when Option 4395A-1D6 Time-Gated Spectrum Analysis is Installed

All specifications are identical to the standard Agilent 4395A except the following items.

Gate length

Range 6 μ s to 3.2 s

Resolution

Range of gate length (T_l)	Resolution
$6 \mu\text{s} \leq T_l \leq 25 \text{ ms}$	0.4 μ s
$25 \text{ ms} < T_l \leq 64 \text{ ms}$	1 μ s
$64 \text{ ms} < T_l \leq 130 \text{ ms}$	2 μ s
$130 \text{ ms} < T_l \leq 320 \text{ ms}$	5 μ s
$320 \text{ ms} < T_l \leq 1.28 \text{ s}$	20 μ s
$1.28\text{s} < T_l \leq 3.2 \text{ s}$	100 μ s

Gate length

Range 0.8 μ s to 3.2 s

Resolution

Range of gate delay (T_d)	Resolution
$0.8 \mu\text{s} \leq T_d \leq 25 \text{ ms}$	0.4 μ s
$25 \text{ ms} < T_d \leq 64 \text{ ms}$	1 μ s
$64 \text{ ms} < T_d \leq 130 \text{ ms}$	2 μ s
$130 \text{ ms} < T_d \leq 320 \text{ ms}$	5 μ s
$320 \text{ ms} < T_d \leq 1.28 \text{ s}$	20 μ s
$1.28 \text{ s} < T_d \leq 3.2 \text{ s}$	100 μ s

Additional amplitude error

Log scale < 0.3 dB (SPC)

Linear scale < 3% (SPC)

Gate control modes Edge (positive/negative) or level

Gate trigger input (external trigger input is used)

Connector BNC female

Level TTL

Gate output

Connector BNC female

Level TTL

Option 4395A-010 Impedance measurement

The following specifications are applied when the 43961A impedance test kit is connected to the 4395A.

Measurement functions

Measurement parameters
Display parameters

Z, Y, L, C, Q, R, X, G, B, θ
|Z|, θ_z , R, X, |Y|, θ_y , G, B, | Γ |, θ_Γ , Γ_x , Γ_y , C_p, C_s,
L_p, L_s, R_p, R_s, D, Q

Display formats

- Vertical lin/log scale
- Complex plane
- Polar/Smith/admittance chart

Sweep parameters

- Linear frequency sweep
- Logarithmic frequency sweep
- List frequency sweep
- Power sweep (in dBm unit)

IF bandwidth

- 2, 10, 30, 100, 300, 1k, 3k, 10k, 30k [Hz]

Calibration

- OPEN/SHORT/LOAD 3 term calibration
- Fixture compensation
- Port extension correction

Measurement port type

- 7-mm

Output characteristics

Frequency range 100 kHz to 500 MHz

Frequency resolution 1 mHz

Output impedance 50 Ω nominal

Output level

when the measurement port is terminated by 50 Ω ¹ -56 to +9 dBm

when the measurement port is open 0.71 mVrms to 1.26 Vrms

Resolution 0.1 dB

Level accuracy

frequency < 1 MHz — $\pm (A + 3)$ [dB]

frequency \geq 1 MHz — $\pm (A + 1)$ [dB]

where, A is the sum total of level accuracy, level linearity and level flatness specifications for output characteristics of network measurement.

1. When the measurement port is terminated with 50 Ω , the signal level at the measurement port is 6 dB lower than the signal level at the RF OUT port.

Measurement

Basic Accuracy

(Supplemental performance characteristics)

Measurement accuracy is specified at the connecting surface of the 7-mm connector of the Agilent 43961A under the following conditions:

- Warm up time** > 30 minutes
- Ambient temperature** 23 °C ± 5 °C,
within ±1 °C from the temperature at which calibration is performed
- Signal level (setting)** 0 to +15 dBm
- Correction** ON
- IFBW (for calibration and measurement)** ≤ 300 Hz
- Averaging factor (for calibration and measurement)** ≥ 8

At the following points, measurement error may exceed the performance described in this section: 124.0 MHz, 136.0 MHz, 415.0 MHz

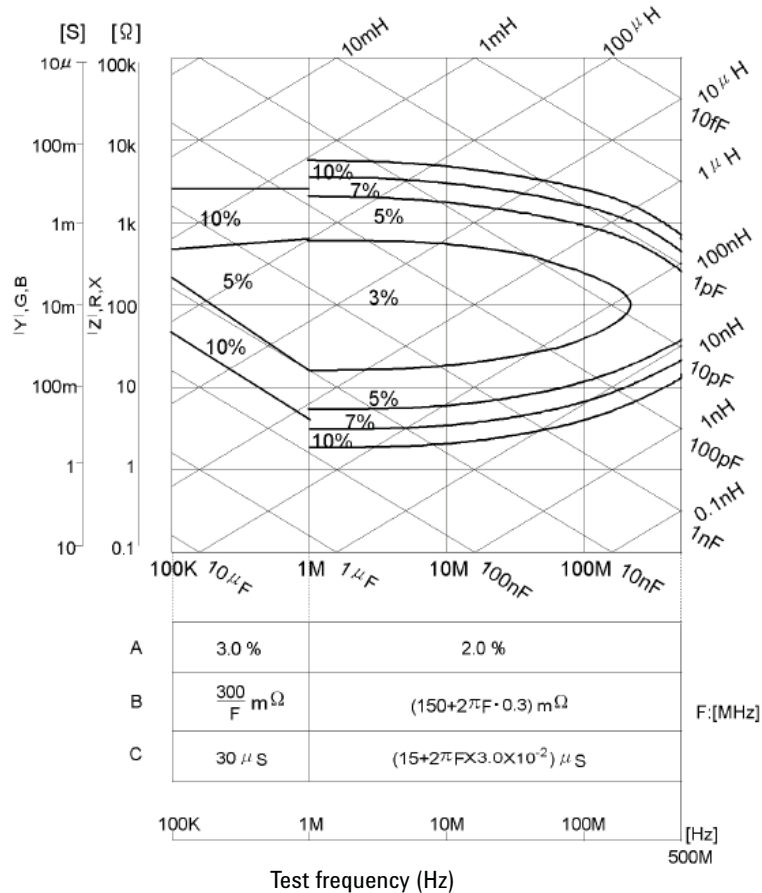

Figure 1-7. Impedance measurement accuracy

IZI - θ accuracy

IZI accuracy $Z_{\alpha} = A + (B/|Z_m| + C \times |Z_m|) \times 100$ [%]

θ accuracy $\theta_{\alpha} = \sin^{-1}(Z_{\alpha}/100)$

Where, $|Z_m|$ is IZI measured. A, B, and C are obtained from Figure 1-7.

IYI - θ accuracy

IYI accuracy $Y_{\alpha} = A + (B \times |Y_m| + C/|Y_m|) \times 100$ [%]

θ accuracy $\theta_{\alpha} = \sin^{-1}(Y_{\alpha}/100)$

Where, $|Y_m|$ is IYI measured. A, B, and C are obtained from Figure 1-7.

R - X accuracy (depends on D)

Accuracy	$D \leq 0.2$	$0.2 < D \leq 5$	$5 < D$
R_a	$\pm X_m \times X_a / 100[\Omega]$	$R_a / \cos\theta[\%]$	$R_a[\%]$
X_a	$X_a[\%]$	$X_a / \sin\theta[\%]$	$\pm R_m \times R_a / 100[\Omega]$

Where,

D can be calculated as: R/X , or
 $R/(2\pi f \times L_s)$, or
 $R \times 2\pi f \times C_s$

θ can be calculated as: $\tan^{-1}(X/R)$, or
 $\tan^{-1}(2\pi f \times L_s/R)$, or
 $\tan^{-1}(1/(R \times 2\pi f \times C_s))$

$$R_a = A + (B/|R_m| + C \times |R_m|) \times 100[\%]$$

$$X_a = A + (B/|X_m| + C \times |X_m|) \times 100[\%]$$

R_m and X_m are the measured R and X, respectively. A, B, and C are obtained from Figure 1-7.

G - B accuracy (depends on D)

Accuracy	$D \leq 0.2$	$0.2 < D \leq 5$	$5 < D$
G_a	$\pm B_m \times B_a / 100[S]$	$G_a / \cos\theta[\%]$	$G_a[\%]$
B_a	$B_a[\%]$	$B_a / \sin\theta[\%]$	$\pm G_m \times G_a / 100[S]$

Where,

D can be calculated as: G/B , or
 $G/(2\pi f \times C_p)$, or
 $G \times 2\pi f \times L_p$

θ can be calculated as: $\tan^{-1}(B/G)$, or
 $\tan^{-1}(2\pi f \times C_p/G)$, or
 $\tan^{-1}(1/(G \times 2\pi f \times L_p))$

$$G_a = A + (B/|G_m| + C \times |G_m|) \times 100[\%]$$

$$B_a = A + (B/|B_m| + C \times |B_m|) \times 100[\%]$$

G_m and B_m are the measured G and B, respectively. A, B, and C are obtained from Figure 1-7.

D accuracy

Accuracy	$D \leq 0.2$	$0.2 < D$
D_a	$Z_a/100$	$(Z_a/100) \times (1 + D^2)$

Where, Z_a is |Z| accuracy.

L accuracy (depends on D)

Accuracy	$D \leq 0.2$	$0.2 < D$
L_a	L_a	$L_a (1 + D)$

Where, $L_a = A + (B/|Z_l| + C \times |Z_l|) \times 100[\%]$

$|Z_l| = 2\pi f \times L_m$, f is frequency in Hz, and L_m is measured L. A, B, and C are obtained from Figure 1-7.

C accuracy (depends on D)

Accuracy	$D \leq 0.2$	$0.2 < D$
C_a	C_a	$C_a (1 + D)$

Where, $C_a = A + (B/|Z_c| + C \times |Z_c|) \times 100[\%]$

$|Z_c| = (2\pi f \times C_m)^{-1}$ f is frequency in Hz, and C_m is measured C. A, B, and C are obtained from Figure 1-7.

Common to Network/ Spectrum/ Impedance Measurement

Display	
LCD	
Size/type	8.4 inch color LCD
Number of pixels	640 x 480
Effective display area	160 mm x 115 mm (600 x 430 dots)
Number of display channels	2
Format single, dual (split or overwrite)	
Number of traces	
For measurement	2 traces
For memory	2 traces
Data math	
	gain x data – offset,
	gain x (data - memory) – offset,
	gain x (data + memory) – offset,
	gain x (data/memory) – offset
Data hold	Maximum hold, minimum hold
Marker	
Number of markers	
Main marker	1 for each channel
Sub-marker	7 for each channel
Δ marker	1 for each channel
Hard copy	
Mode	Dump mode only (including color dump mode)
Storage	
Built-in flexible disk drive	
Type	3.5 inch, 1.44 MByte, or 720 KByte, 1.44 MByte format is used for disk initialization
Memory	512 KByte, can be backed up by flash memory
GPIB	
Interface	IEEE 488.1-1987, IEEE 488.2-1987, IEC 625, and JIS C 1901-1987 standards compatible.
Interface function	SH1, AH1, T6, TEO, L4, LEO, SR1, RL1, PP0, DC1, DT1, C1, C2, C3, C4, C11, E2
Data transfer formats	ASCII, 32 and 64 bit IEEE 754 floating point format, DOS PC format (32 bit IEEE with byte order reversed)
Printer parallel port	
Interface	IEEE 1284 Centronics standard compliant
Printer control language	HP PCL3 printer control language
Connector	D-SUB (25-pin)

Option 4395A-001 DC voltage/current source

The setting of Option 4395A-001 DC voltage/current source is independent of channel 1 and channel 2 settings.

Voltage

Range -40 V to +40 V

Resolution 1 mV

Current limitation

at voltage setting = -25 V to +25 V ±100 mA

at voltage setting = -40 V to -25 V, 25 V to 40 V ±20 mA

Current

Range -20 µA to -100 mA, 20 µA to 100 mA

Resolution 20 µA

Voltage limitation

at current setting = -20 mA to +20 mA ±40 V

at current setting = -100 mA to -20 mA, 20 mA to 100 mA ±25 V

Accuracy

Voltage

at 23 °C ± 5 °C $\pm(0.1\% + 4 \text{ mV} + I_{dc}^1 [\text{mA}] \times 5 [\Omega] \text{ mV})$

Current

at 23 °C ± 5 °C $\pm(0.5\% + 30 \mu\text{A} + V_{dc}^2 [\text{V}]/10 [\text{k}\Omega] \text{ mA})$

Probe power

Output voltage +15 V (300 mA), -12.6 V (160 mA), GND nominal

Specifications when instrument BASIC is operated

Keyboard PS/2 style 101 English keyboard

Connector mini-DIN

8 bit I/O port

Connector D-SUB (15-pin)

Level TTL

Number of input/output bit 4 bit for input, 8 bit for output

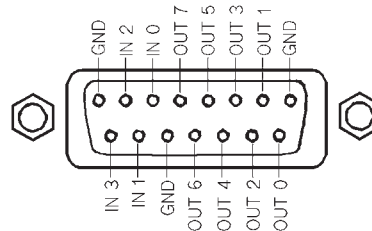

Figure 1-8. 8 bit I/O port pin assignments

24-bit I/O interface

Connector D-SUB (36-pin)

Level TTL

I/O 8-bit for input or output, 16-bit for output

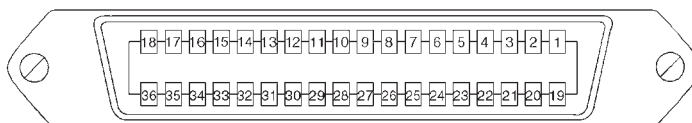

Figure 1-9. 24-bit I/O interface pin assignment

1. Current at DC source connector.
2. Voltage at DC source connector.

Table 1-1. Signal source assignment

Pin No.	Signal name	Signal standard
1	GND	0 V
2	INPUT1	TTL level, pulse input (pulse width: 1 μ s or above)
3	OUTPUT1	TTL level, latch output
4	OUTPUT2	TTL level, latch output
5	OUTPUT PORT A0	TTL level, latch output
6	OUTPUT PORT A1	TTL level, latch output
7	OUTPUT PORT A2	TTL level, latch output
8	OUTPUT PORT A3	TTL level, latch output
9	OUTPUT PORT A4	TTL level, latch output
10	OUTPUT PORT A5	TTL level, latch output
11	OUTPUT PORT A6	TTL level, latch output
12	OUTPUT PORT A7	TTL level, latch output
13	OUTPUT PORT B0	TTL level, latch output
14	OUTPUT PORT B1	TTL level, latch output
15	OUTPUT PORT B2	TTL level, latch output
16	OUTPUT PORT B3	TTL level, latch output
17	OUTPUT PORT B4	TTL level, latch output
18	OUTPUT PORT B5	TTL level, latch output
19	OUTPUT PORT B6	TTL level, latch output
20	OUTPUT PORT B7	TTL level, latch output
21	I/O PORT C0	TTL level, latch output
22	I/O PORT C1	TTL level, latch output
23	I/O PORT C2	TTL level, latch output
24	I/O PORT C3	TTL level, latch output
25	I/O PORT D0	TTL level, latch output
26	I/O PORT D1	TTL level, latch output
27	I/O PORT D2	TTL level, latch output
28	I/O PORT D3	TTL level, latch output
29	PORT C STATUS	TTL level, input mode: LOW, output mode: HIGH
30	PORT D STATUS	TTL level, input mode: LOW, output mode: HIGH
31	WRITE STROBE SIGNAL	TTL level, active low, pulse output (width: 10 μ s; typical)
32	+5 V PULLUP	
33	SWEEP END SIGNAL	TTL level, active low, pulse output (width: 20 μ s; typical)
34	+5 V	+5 V, 100 mA MAX
35	PASS/FAIL SIGNAL	TTL level, PASS: HIGH, FAIL: LOW, latch output
36	PASS/FAIL WRITE STROBE SIGNAL	TTL level, active low, pulse output (width: 10 μ s; typical)

General Characteristics

Input and output characteristics

External reference input

Frequency 10 MHz \pm 100 Hz (SPC)
Level -5 dBm to +5 dBm (SPC)
Input impedance 50 Ω nominal
Connector BNC female

Internal reference output

Frequency 10 MHz nominal
Level 0 dBm (SPC)
Output impedance 50 Ω nominal
Connector BNC female

Reference oven output (Option 4395A-1D5)

Frequency 10 MHz nominal
Level 0 dBm (SPC)
Output impedance 50 Ω nominal
Connector BNC female

External trigger input

Level TTL
Pulse width (T_p) $\geq 2 \mu\text{s}$ typically
Polarity positive/negative selective
Connector BNC female

External program Run/Cont input

Connector BNC female
Level TTL

Gate output (Option 4395A-1D6)

Level TTL
Connector BNC female

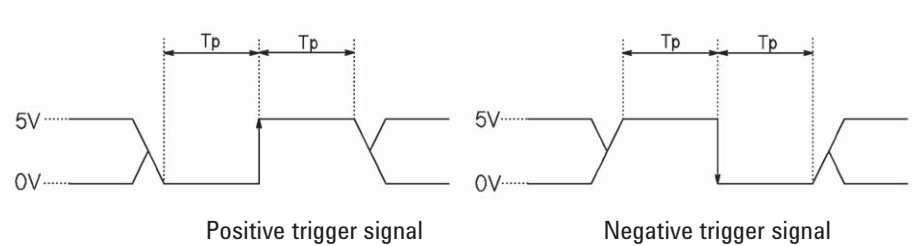

Figure 1-10. Trigger signal (external trigger input)

S-parameter test set interface

Connector D-SUB (25-pin)

Caution

Do not connect a printer to this connector. If you connect a printer with the S-parameter test set interface connector (TEST SET-I/O INTERCONNECT), it may cause damage to the printer.

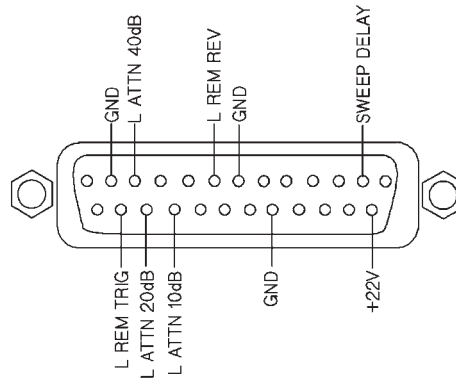

Figure 1-11. S-parameter test set interface pin assignments

External monitor output

Connector D-SUB (15-pin HD)

Display resolution 640 x 480 VGA

Operation conditions

Temperature

Disk drive non-operating condition 0 °C to 40 °C

Disk drive operating condition 10 °C to 40 °C

Humidity

at wet bulb temperature ≤ 29 °C, without condensation

Disk drive non-operating condition 15% to 95% RH

Disk drive operating condition 15% to 80% RH

Altitude 0 to 2,000 m

Warm up time 30 minutes

Non-operation conditions

Temperature -20 °C to 60 °C

Humidity

at wet bulb temperature ≤ 45 °C, without condensation. 15% to 95% RH

Altitude 0 to 4,572 m

Others

EMCComplies with CISPR 11 (1990) / EN 55011(1991) : Group 1, Class A

Complies with EN 50082-1 (1992) / IEC 1000-4-2 (1995) : 4 kV CD, 8 kV AD

Complies with EN 50082-1 (1992) / IEC 801-3 (1984) : 3 V/m

Complies with EN 50082-1 (1992) / IEC 1000-4-4 (1995) :1 kV / Main, 0.5kV /Signal line

Complies with IEC 1000-3-2 (1995) / EN 61000-3-2 (1995)

Complies with IEC 1000-3-3 (1994) / EN 61000-3-3 (1995)

Safety Complies with IEC 1010-1 (1990),
Amendment 1(1992), Amendment 2 (1995)
Certified by CSA-C22.2 No.1010.1-92

Power requirements 90 V to 132 V, or 198 V to 264 V (automatically switched),
47 to 63 Hz, 300 VA max.

Weight 21 kg (SPC)

Dimensions 425 (W) x 235 (H) x 553 (D) mm



Agilent Email Updates

www.agilent.com/find/emailupdates

Get the latest information on the products and applications you select.



Agilent Direct

www.agilent.com/find/agilentdirect

Quickly choose and use your test equipment solutions with confidence.

Remove all doubt

Our repair and calibration services will get your equipment back to you, performing like new, when promised. You will get full value out of your Agilent equipment throughout its lifetime. Your equipment will be serviced by Agilent-trained technicians using the latest factory calibration procedures, automated repair diagnostics and genuine parts. You will always have the utmost confidence in your measurements.

Agilent offers a wide range of additional expert test and measurement services for your equipment, including initial start-up assistance, onsite education and training, as well as design, system integration, and project management.

For more information on repair and calibration services, go to:

www.agilent.com/find/removealldoubt

www.agilent.com

For more information on Agilent Technologies' products, applications or services, please contact your local Agilent office. The complete list is available at:

www.agilent.com/find/contactus

Americas

Canada	(877) 894-4414
Latin America	305 269 7500
United States	(800) 829-4444

Asia Pacific

Australia	1 800 629 485
China	800 810 0189
Hong Kong	800 938 693
India	1 800 112 929
Japan	0120 (421) 345
Korea	080 769 0800
Malaysia	1 800 888 848
Singapore	1 800 375 8100
Taiwan	0800 047 866
Thailand	1 800 226 008

Europe & Middle East

Austria	0820 87 44 11
Belgium	32 (0) 2 404 93 40
Denmark	45 70 13 15 15
Finland	358 (0) 10 855 2100
France	0825 010 700*
Germany	01805 24 6333**
Ireland	1890 924 204
Israel	972-3-9288-504/544
Italy	39 02 92 60 8484
Netherlands	31 (0) 20 547 2111
Spain	34 (91) 631 3300
Sweden	0200-88 22 55
Switzerland (French)	41 (21) 8113811(Opt 2)
Switzerland (German)	0800 80 53 53 (Opt 1)
United Kingdom	44 (0) 118 9276201

Other European Countries:

www.agilent.com/find/contactus

Revised: October 24, 2007

Product specifications and descriptions in this document subject to change without notice.

© Agilent Technologies, Inc. 2001, 2003, 2007, 2008
Printed in USA, February 28, 2008
5965-9340E



Agilent Technologies