



Providing clean air in your workplace.

Fume Extraction Solutions

Weller[®]FT
FILTER SYSTEMS

Why Fume Extraction?	4
Solutions for Clean Air	5
Filter Efficiency Comparisons	6
WellerFT Gas Filters	7
Filter Options	8
2 Types of Fume Extraction	9
Volume Extraction	10–41
Volume Extraction / Technical Data	10–13
Volume Extraction Units	14–25
Funnel and Nozzle Kits	26
Fume Extraction Pressure Drop	27
Easy-Click-60 Extraction Arms	28–29
Volume Extraction Accessories	30–35
Installation Options With Easy-Click System	36–39
Extraction Hoods	40
Clean Bench Concept CBC-A	41
Tip Extraction	42–45
Tip Extraction Unit	43
Tip Extraction Accessories	44
Tip Extraction Installation Options	45
Filter Compatibility Chart	46–48
Filters	49–51

Soldering and adhesive applications produce **harmful particulates and gases**

WellerFT Zero Smog® Systems offer a **3-stage* filter process** for removing harmful airborne substances

Effects of fine dust and gas fumes on the lungs

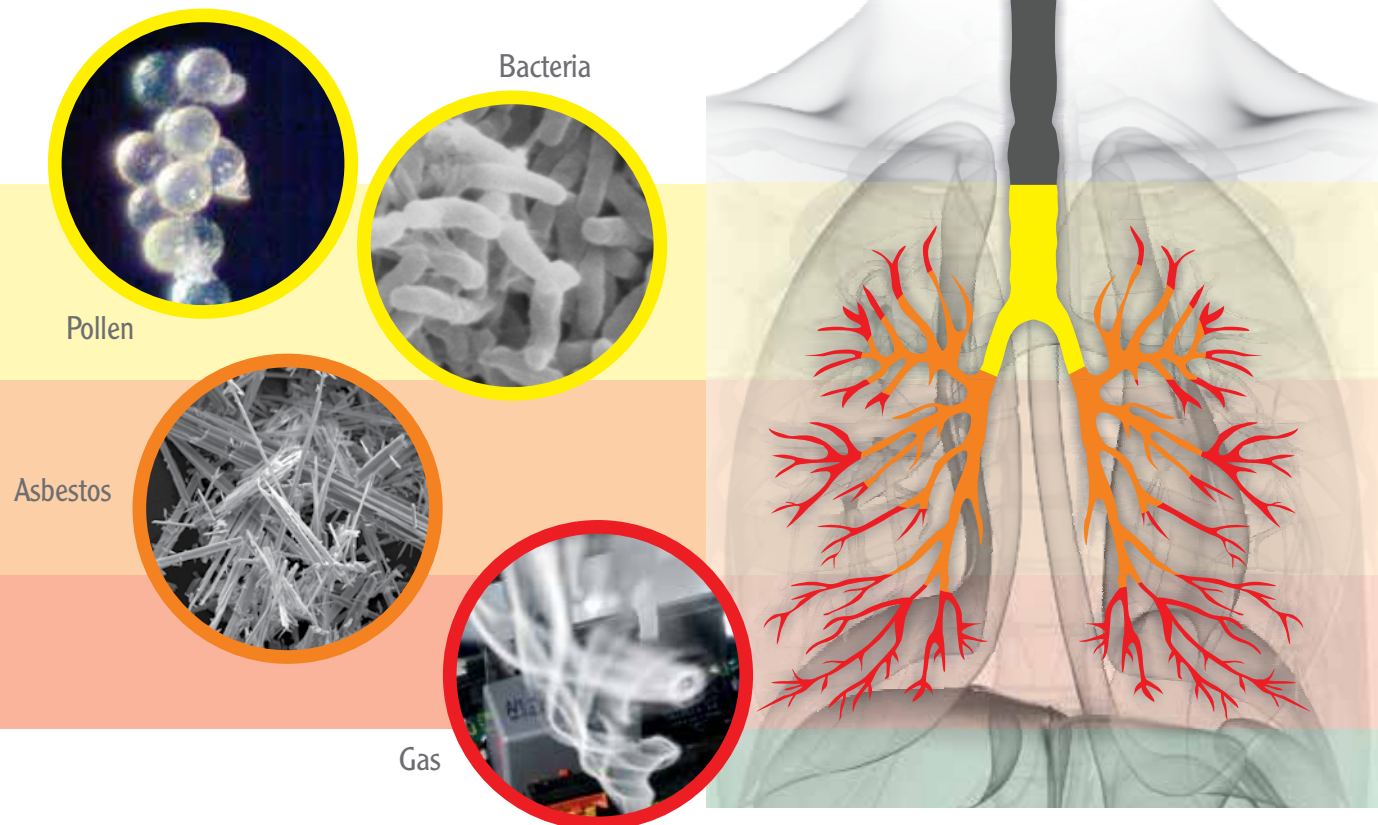

In workplaces that involve the use of soldering and adhesives applications, particulates and gases are released that can be harmful to people and the environment. It is a common misconception that lead-free soldering is safer and more ecologically sustainable. Smoke from lead-free soldering contains fine dust particles because of the higher working temperatures required and because higher percentages of flux can be used in the soldering process.

In many countries legal regulations governing clean air in the work place require that hazardous substances are removed from the air in order to avoid harmful effects on people and machines.

To protect the operator it is important to use an extraction system that is able to separate these particles and gases and then recirculates the cleaned air back into the work place. This also saves energy and reduces energy costs.

- > The smaller the particles, the deeper they penetrate into the respiratory system
- > The smallest particles travel via alveoli into the bloodstream
- > The deeper the particles penetrate, the greater the health risks

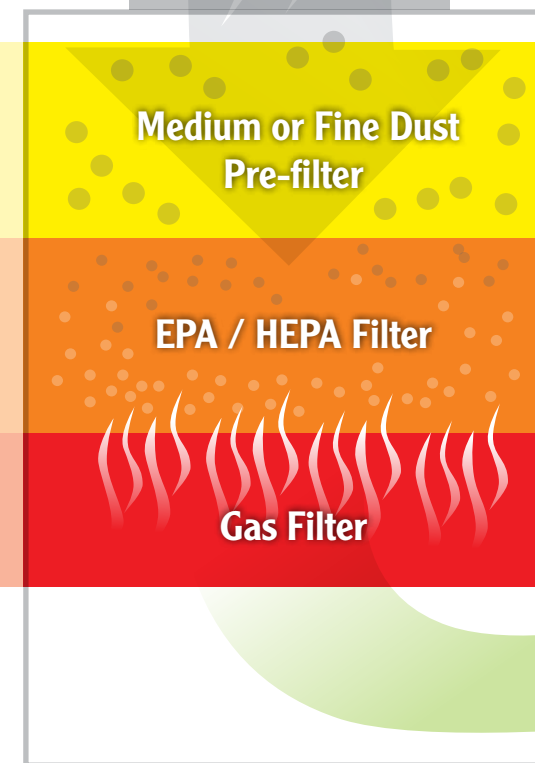

- 1** Larger particles become trapped in the medium or fine dust M5 or F7 pre-filter.
- 2** Smaller particles become trapped in the EPA or HEPA particle filter.
- 3** The wide band gas filter removes adhesive and solvent fumes.

Clean air is recirculated back into the workplace.

**In some cases, only a prefilter / gas filter combination is required.*

90 minutes soldering with lead-free solder



Why fume extraction? See the movie on www.youtube.com/wellersoldering



WellerFT offers the **highest efficiency dust filters** to remove large to very small particles

WellerFT **wide band gas filters** remove offensive odors and fume irritants

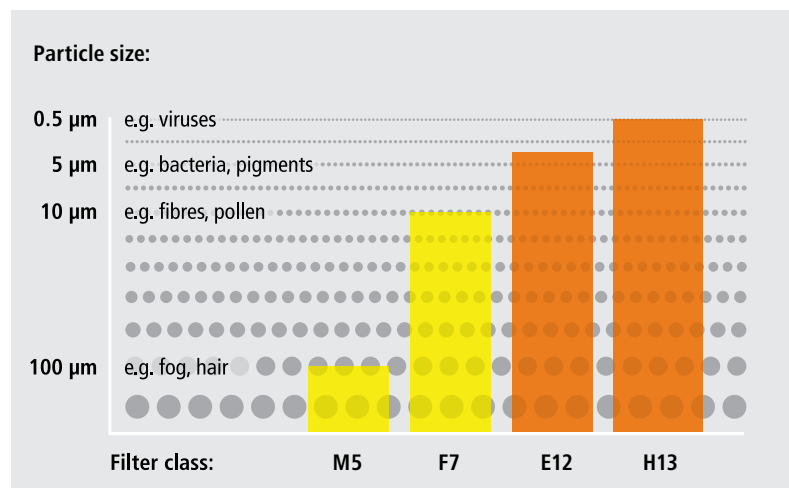

Filter Class M5, F7: Fine dust filter as per EN 779:2012
 Filter Class E12/H13: According EN 1822:2009 HEPA (High Efficiency Particulate Air) Filter

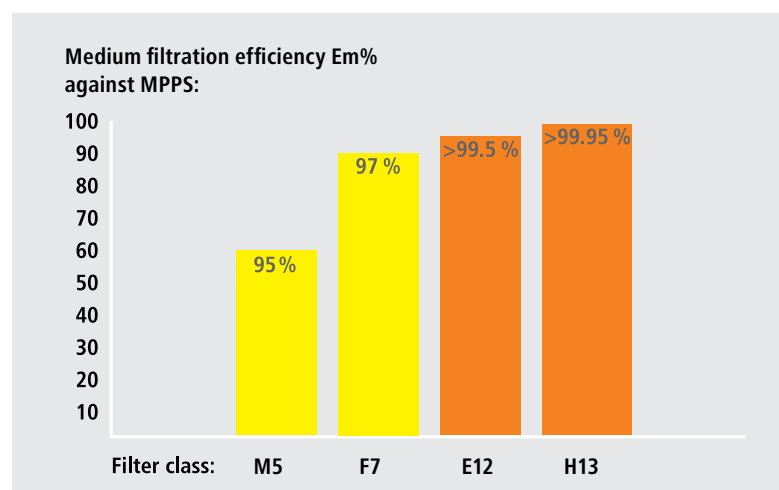

What are dust filter classes?

Filters are classified based on the size of the particle that they can keep from returning back into the environment. The smaller the particles are, the deeper they penetrate into the respiratory system. The smallest particles travel via alveoli into the bloodstream. The top graph shows filter classes and the size of the particles they can efficiently filter. Particles are measured in microns, which is one millionth of a meter.

Each filter class is assigned an efficiency rating based on the ability to filter MPPS (Most Penetrating Particle Size). HEPA filters have efficiencies of at least 99.95% at 0.3 microns. The most penetrating size is a function of the structure of the filter medium, the velocity of the airflow through the filter, and the physical and chemical nature of the particles.

– Source: HEPA Corporation

Breathe easier with our standard compact filters

Harmful gases with a high molecular weight are cleaned by the active carbon. Chemisorb (potassium permanganate) is suitable for absorbing gases of lower molecular weight. Because of its composition, Chemisorb is able to convert a large number of chemical pollutants (formaldehyde) by means of molecular modification into non-polluting gases.

Also offering these specialized gas filters:



Cleanroom gas filter

Chemical filter to control airborne molecular contamination (AMC)



MEK gas filter

Chemical filter to control methyl ethyl ketone



Adhesive fume filter

For gluing and dry processes in dispensing applications



VOC gas filter

Chemical filter to control volatile organic compounds in gluing and dry processes

Group	Filter class	Integral value	
		Degree of separation	Transmittance degree
EPA	E10	85%	15%
	E11	95%	5%
	E12	99.5%	0.5%
HEPA	H13	99.95%	0.05%
	H14	99.995%	0.005%

} **WellerFT ultrafine particulate filters**

Choose a WellerFT filter configuration customized to fit your workplace

WellerFT Zero-Smog® systems are specifically designed for continuous operation in industrial environments. Care and attention at the design stage plus careful component choice and a high quality manufacturing process have given Weller®FT extraction systems a worldwide reputation for reliability and longevity.

Filter classification

according to EN norm EN 1822:2009

Medium / Fine dust pre-filters

For standard applications with a small amount of flux and pollution gases with high solid content, Weller®FT offers filter classes M5 or F7.

EPA / HEPA Compact filters

- Particle filter class H13 or E12 with deposition performance according to EN 1822:2009
 - > 99.955% in MPPS (particles 0.16 µm)
 - > 99.994% @ particles 0.3 µm

- Wide band gas filter (optional)

Gas filters

For cleaning harmful fumes and vapors, Weller wide band gas filters consist of varying levels of chemical absorption media to meet the demanding needs of the market requirements.



Weller®FT offers 2 types of fume extraction:

Volume extraction

pages 10–41

Volume extraction is the best choice where extraction over a wide area is required. It is an economical way to eliminate polluted process air as there is no need for fixed installations and maintenance requirements are minimized.



For 1 extraction arm Ø 60

Volume flow rate = 50–80 m³/h
Underpressure = 300–700 Pa

Tip extraction

pages 42–45

Choose tip extraction when you need to eliminate toxic fumes right at the source. WellerFT FE75 soldering irons have an integral smoke tube in the handle. Weller also offers universal FE attachments that can be retrofitted to Weller standard series soldering irons. Point of source extraction positions the smoke tube directly over the tip to collect the majority of flux fumes that are created when performing hand soldering applications.



For 1 FE soldering iron

Volume flow rate = 1–1.5 m³/h
Underpressure = 10,000 Pa



Areas of application

- > Hand soldering processes
- > Soldering machines, robots, solder baths
- > Adhesive fumes
- > Clean room applications (product specific – see Technical Data chart, pages 12 and 13)
- > Microscope workplaces
- > Other fume emitting processes

Volume extraction is the best choice where extraction over a wide area is required. It is an economical way to eliminate polluted process air as there is no need for fixed installations and maintenance requirements are minimized.

Arms and nozzles do not require daily cleaning. Energy costs are saved because the cleaned air is re-circulated back into the work area and does not need to be heated or cooled like external air.

Weller® has a broad range of filter units for volume extraction applications. Speed control allows optimal air flow regulation for each working place independent of the connected workplaces (excludes Zero Smog® 2).

Units can be remotely controlled via a remote control (optional accessory) or by a PC (RS232) connection (excludes Zero Smog® 2). Easy-Click system ensures fast and easy installation of workplaces.

For wide application areas, choose volume extraction systems



Characteristics

- > For applications over a wide working area
- > Mobile units suitable for stand alone applications
- > All units equipped with maintenance-free brushless turbine
- > Connects to external air outlet (only ZS4V/6V)
- > Vacuum force up to 3,000 Pa for efficient volume extraction
- > Flexible extraction arms for ease in placement



Available Q3-15



up to 2 workplaces



up to 2 workplaces



up to 2 workplaces

	ZeroSmog2	MG130	MG100S
Dimensions L x B x H (mm / in)	360 x 330 x 415 mm 14.17 x 12.99 x 16.33 in	460 x 210 x 500 mm 18.11 x 8.26 x 19.68 in	460 x 210 x 610 mm 18.11 x 8.26 x 24.15 in
Weight (kg / lb)	9 kg / 19.8 lb	11 kg / 24.3 lb	15 kg / 33.1 lb
Voltage	120 V. 60 Hz	100–240 V. 50/60 Hz	100–240 V. 50/60 Hz
Noise level at 1 m *	50 dB (A)	48 dB (A)	48 dB (A)
Electrical power	200 W	100 W	100 W
Max. blower vacuum	3,000 Pa	2,300 Pa	2,300 Pa
Max. blower capacity	220 m³/h	140 m³/h	140 m³/h
Pre-filter	Medium dust filter M5	Fine dust filter F7	–
Compact filter	Particle filter E12 + gas filter (active carbon foam) low	H13 particle filter + gas filter (50% active carbon + 50% Chemisorb)	H13 particle filter + gas filter (50% active carbon + 50% Chemisorb)
Gas filter volume	low	low	high
Particle filter separation degree MPPS	> 99.5%	> 99.95%	> 99.95%

* At typical operating speed

Selection guide based on particle and gas filter capacity

Application	ZeroSmog2	MG130	MG100S
Hand soldering	++	++	+++
Heavy duty soldering (solder bath, selective wave)	+	+	+
Soldering	+	++	+++
Gluing, Cleaning, Filling	+	++	+++
Finedust	++	++	+
MEK (Methyl Ethyl Ketone)		+	+++
VOC (Volatile Organic Compounds)		+	+++
Cleanroom			+++

+ short term use ++ medium term use +++ long term use



up to 2 workplaces



up to 4 workplaces



up to 8 workplaces

	MG140	ZeroSmog4V	ZeroSmog6V
Dimensions L x B x H (mm / in)	350 x 335 x 655 mm 13.77 x 13.18 x 25.78 in	345 x 325 x 505 mm 13.58 x 12.79 x 19.88 in	460 x 460 x 665 mm 18.11 x 18.11 x 26.18 in
Weight (kg / lb)	18 kg / 39.7 lb	19 kg / 41.9 lb	40 kg / 88.2 lb
Voltage	100–240 V. 50/60 Hz	120 V. 60 Hz	120 V. 60 Hz
Noise level at 1 m *	44 dB (A)	48 dB (A)	51 dB (A)
Electrical power	100 W	275 W	460 W
Max. blower vacuum	2,300 Pa	2,700 Pa	3,000 Pa
Max. blower capacity	140 m³/h	230 m³/h	615 m³/h
Pre-filter	Fine dust filter F7	Fine dust filter F7	Fine dust filter F7
Compact filter	H13 particle filter + gas filter (50% active carbon + 50% Chemisorb)	H13 particle filter + gas filter (50% active carbon + 50% Chemisorb)	H13 particle filter + gas filter (50% active carbon + 50% Chemisorb)
Gas filter volume	high	medium	high
Particle filter separation degree MPPS	> 99.95%	> 99.95%	> 99.95%

* At typical operating speed

Application	MG140	ZeroSmog4V	ZeroSmog6V
Hand soldering	+++	+++	+++
Heavy duty soldering (solder bath, selective wave)	++	++	+++
Soldering	+++	++	+++
Gluing, Cleaning, Filling	+++	+++	+++
Finedust	+++	++	+++
MEK (Methyl Ethyl Ketone)	+++	+	+
VOC (Volatile Organic Compounds)	+++	+	+++
Cleanroom	+++		

+ short term use ++ medium term use +++ long term use

Zero Smog 2

This small, economical system is fully armed to zero in on fumes.

Available
Q3-15



Applications

- > Hand soldering
- > Heavy duty and general soldering
- > Gluing, cleaning, filling

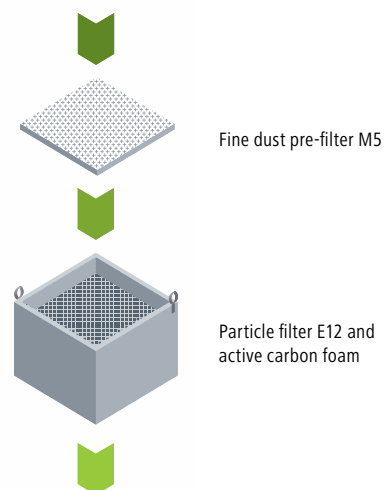

Attributes

- > Economical unit purifies air up to 2 workplaces
- > Easy filter exchange
- > Quick and simple installation
- > Portable fume extraction unit

Zero Smog[®] 2

What's included:

- > E12 particle filter and active carbon foam
- > Medium dust pre-filter M5

Order No. 120 V

ZEROSMOG2



low sound level



Zero Smog[®] 2 Kit

What's included:

- > Zero Smog 2
- > Kit 1 ALFA Funnel (see page 28)

Order No. 120 V

ZEROSMOG2KIT1

MG130

Air purification right at your elbow.



Applications

- > Hand soldering
- > Heavy duty and general soldering
- > Gluing, cleaning, filling
- > Fine dust
- > MEK
- > Cleanroom

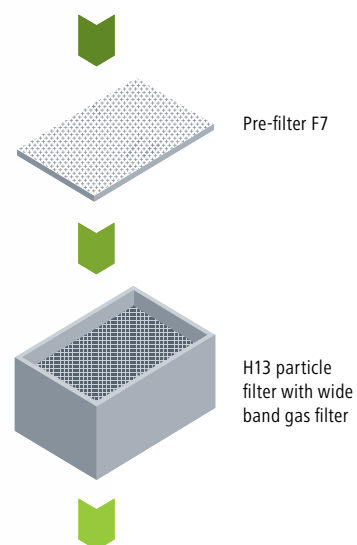

Attributes

- > Unit purifies air up to 2 workplaces
- > Filter alarm and 3-step speed control
- > Compact footprint
- > 100–240 V power supply

MG130

What's included:

- MG130 Fume extraction unit 100–240 V / 50/60 Hz
- > Compact filter consists of: H13 particle filter and wide band gas filter (50% active carbon + 50% Chemisorb)
- > Pre-filter F7

Order No. 100–240 V U-130-1000-ESD

The MG130 Kit includes two flexible arms, and can be placed close to the workbench.

MG130 Kits

MG130 Kit Nozzle

- consists of:
- > MG130 fume extraction unit
- > Two OF10 extraction arms
- > Two ALFA nozzles
- > Arms attach directly to unit – no mounting hardware needed

Order No. U-130-1055-ESD



ESD safe



low sound level



MG100S

Handles large volumes of gas fumes and vapors for up to 2 workplaces



Applications

- > Hand soldering
- > Heavy duty and general soldering
- > Gluing, cleaning, filling
- > Fine dust
- > MEK
- > VOC

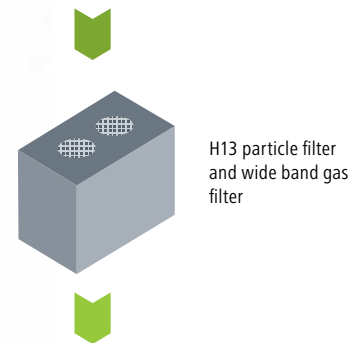

H13 particle filter and wide band gas filter



Attributes

- > Unit purifies air at up to 2 workplaces
- > High volume gas filter
- > Electronic filter control with filter alarm
- > 3-speed setting
- > Compact footprint
- > Switching power supply 100–240 V
- > Optimized filter lifetime



Can be equipped with a special filter suitable for different applications.

MG100S

What's included:

- > MG 100S Fume extraction unit 120 V / 50/60 Hz
- > Compact filter consists of: H13 particle filter and wide band gas filter (50% active carbon / 50% Chemisorb)

MG 100S Filter System 120 V **Order No. U-100-1000-ESD**

Accessory

Remote control with 1 m cable **Order No. 700-3057**

MG100S Kits

MG100S Kit 1

- > MG 100S
- > Kit 1 Funnel (see page 28)

Order No. 120 V **U-100-1056-ESD**

MG100S Kit 2

- > MG 100S
- > Two Kit 1 Funnel (see page 28)

Order No. 120 V **U-100-1055-ESD**



ESD safe

low sound level

MG140

The portable, powerful MG140 eliminates heavy-duty gas and particle emissions



Applications

- > Hand soldering
- > Heavy duty and general soldering
- > Gluing, cleaning, filling
- > Fine dust
- > MEK
- > VOC
- > Clean room

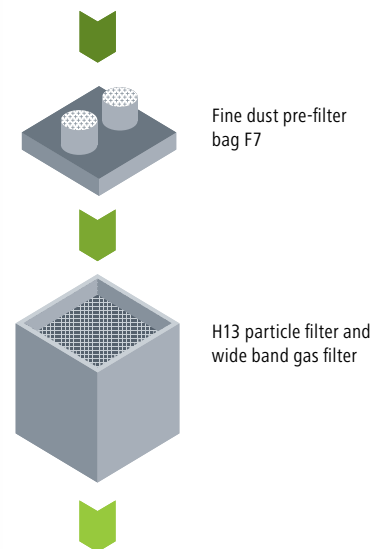

Attributes

- > Unit purifies air at up to 2 workplaces
- > High volume gas filter
- > Electronic filter control with filter alarm
- > Variable speed setting
- > 3-step filter system
- > Quick and simple installation
- > 4 wheels for easy movement
- > Switching power supply 100–240 V

MG140

What's included:

- > MG140 Fume extraction unit 100–240 V / 50/60 Hz
- > Compact filter consists of: particle filter H13 and wide band gas filter (50% active carbon / 50% Chemisorb)
- > Pre-filter F7

MG140 Filter unit 120 V **Order No. U-145-1000-ESD**

MG140 with cleanroom filter

What's included:

- > MG140 Filter unit 120V with cleanroom filter **Order No. U-145-1002-ESD**

Accessory (Optional)

Remote control with cable **Order No. 700-3057**

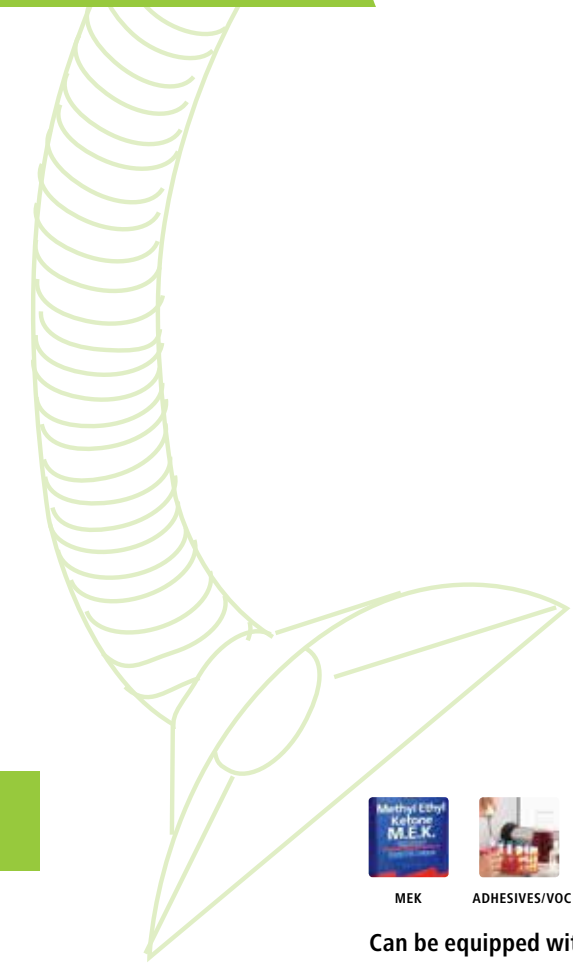

Can be equipped with a special filter suitable for different applications.

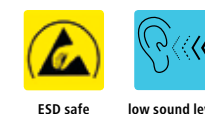

Zero Smog[®] 4V

Energy-efficient fume extraction system provides clean air for up to 4 workplaces



Applications

- > Hand soldering
- > Heavy duty and general soldering
- > Gluing, cleaning, filling
- > Fine dust
- > MEK
- > VOC

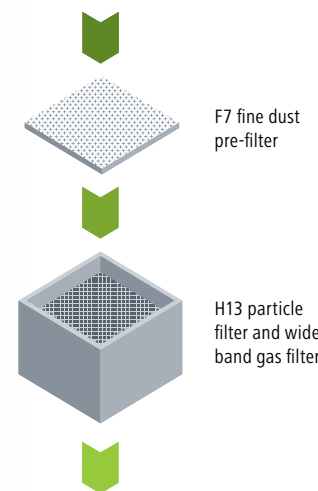

The fume extraction unit Zero Smog[®]4V (ZS4V) is easy to install and operate. The kit is supplied with one flexible hose, one attachment arm with funnel and one bench mount bracket ready for installation at the workplace. A powerful, maintenance-free turbine provides continuous fume extraction at a maximum air extraction rate of 230 m³/h. When setting the Constant Flow Control, the adjustable turbine speed avoids unnecessary waste of power and saves energy.



Attributes

- > Unit purifies air at up to 4 workplaces
- > Constant Flow Control (CFC) guarantees optimal air flow regulation for each individual workplace
- > Electronic filter control with optical and acoustical filter alarm
- > Efficiency test via USB port
- > 4 wheels to allow easy movement of the unit
- > Remote control via RS 232 port
- > Low noise level



Can be equipped with a special filter suitable for different applications.

Zero Smog[®] 4V with compact filter

What's included:

- > Compact filter consists of: particle filter H13 and wide band gas filter (50% active carbon / 50% Chemisorb)
- > F7 fine dust pre-filter

Order No. 100–120 V **T0053660299**

Zero Smog[®] 4V with gas filter

What's included:

- > Wide band gas filter (50% active carbon / 50% Chemisorb)

Order No. 100–120 V **T0053661299**



ESD safe



low sound level



Available with Funnel Nozzle Kits

Kit 1 Zero Smog[®] 4V with ALFA Funnel Nozzle

(page 26) which contains

- > ALFA funnel nozzle
- > Extraction arm
- > Stop valve with bench mounting brackets
- > Extraction hose

Order No. 100–120 V **T0053662299**

Kit 2 Zero Smog[®] 4V with ALFA Funnel Nozzle

> Kit 2 contains 2 of everything in Kit 1 above

Order No. 100–120 V **T0053664299**

Zero Smog® 6V

Quiet, small but powerful ZS6V provides continuous clean air for up to 8 workplaces



Applications

- > Hand soldering
- > Heavy duty and general soldering
- > Gluing, cleaning, filling
- > Fine dust
- > MEK
- > VOC

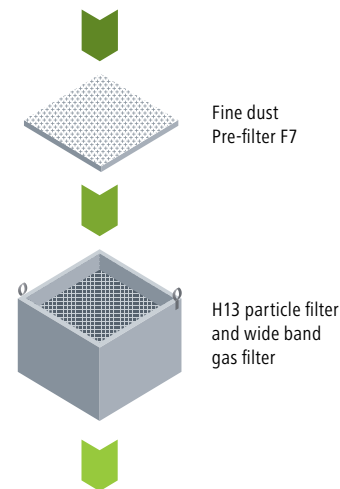

The ZS6V has 3 operating modes:

- 1. Standard speed control**
Selected by the user irrespective of the load on the system.
- 2. Speed limiting control**
The turbine speed is automatically varied to match the load on the system.
- 3. Economy control**
The rate of fume absorption is maintained at a constant value. The operating hours and the filter condition are recorded for maintenance purposes.

The fume extraction system Zero Smog 6V (ZS6V) is user-friendly with quick and simple installation and filter exchange. It has a low noise emission level and is small and convenient to locate within the work area.

The high quality components used in the ZS6V result in low servicing requirements and long system life. To increase filter lifetime and save on energy, the ZS6V is fitted with a constant flow control (CFC) – depending on the number of connected workplaces. To extend the capacity an external pre-filter can be fixed directly to the ZS6V.

The powerful, maintenance-free variable speed turbine is controlled electronically and has a maximum blower capacity of 615 m³/h.



Attributes

- > Unit purifies air at up to 4 workplaces
- > The Constant Flow Control (CFC) guarantees optimal air flow regulation for each individual workplace
- > Electronic filter control with optical and acoustical filter alarm
- > Efficiency test via USB port
- > 4 wheels to allow easy movement of the unit
- > Remote control via RS 232 port
- > Low noise level

Zero Smog® 6V

What's included:

- > ZS6V Fume extraction unit
120 V / 50/60 Hz
- > Compact filter consists of:
H13 particle filter and wide band gas filter
(50% active carbon / 50% Chemisorb)
- > F7 fine dust pre-filter

Order No. 100–120 V T0053666299

Zero Smog® 6V with gas filter

What's included:

- > Compact filter for adhesive fumes consists of:
wide band gas filter (50% active carbon / 50% Chemisorb)
- > F7 fine dust pre-filter

Order No. 100–120 V T0053667299



Optional pre-filter box extends capacity of Zero Smog® 6V

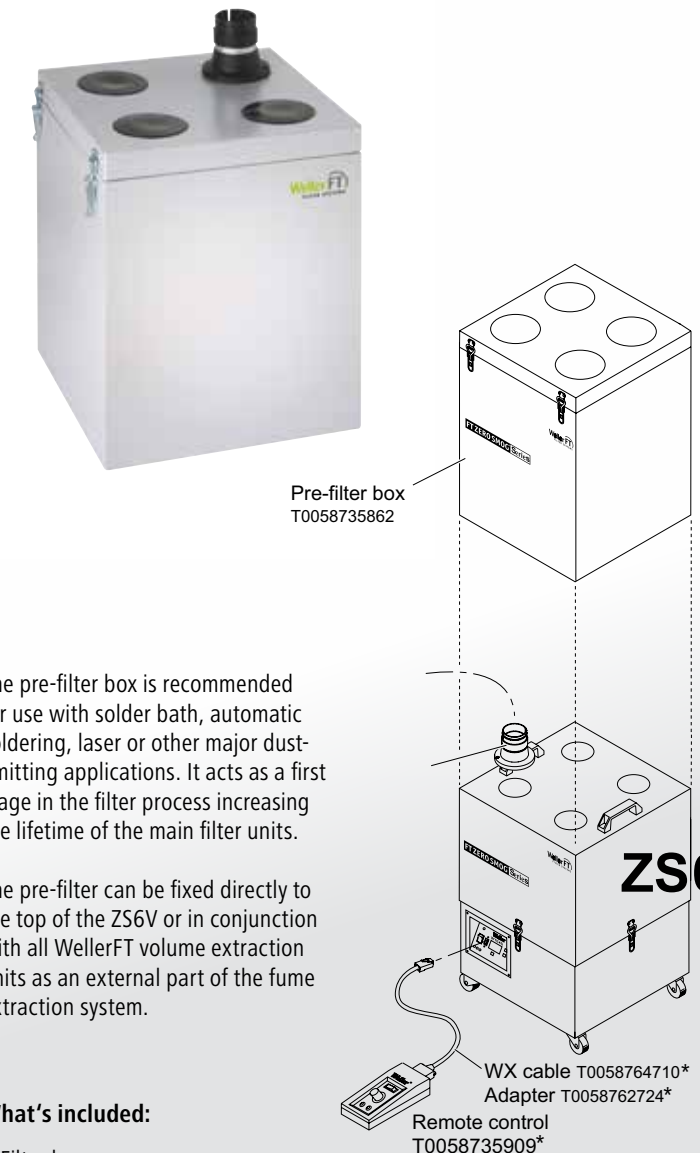

The pre-filter box is recommended for use with solder bath, automatic soldering, laser or other major dust-emitting applications. It acts as a first stage in the filter process increasing the lifetime of the main filter units.

The pre-filter can be fixed directly to the top of the ZS6V or in conjunction with all WellerFT volume extraction units as an external part of the fume extraction system.

What's included:

- > Filter box
- > One Easy-Click-60 connector
Filters must be ordered separately (see page 49)

Order No. T0058735862

*Optional



	KIT 1 ALFA FUNNEL NOZZLE*	KIT 1 SLOPED NOZZLE	KIT 1 SLOPED MICRO NOZZLE	KIT 1S SLOPED NOZZLE	KIT 1S FUNNEL NOZZLE	WFE2ES KIT 1 FUNNEL NOZZLE	MG100S KIT 1 FUNNEL NOZZLE
Model Number							
Order Number	T0053657199	T0053657299	T0058762770	T0053657999	T0058762763	WFE2ESKIT1	U-100-1056-ESD

Funnel nozzle Ø 60mm ALFA	+				+	+	+	+
Sloped nozzle Ø 60mm FT-NL		+		+				
Sloped nozzle Ø 32mm T0058762834			+					
Extraction arm Ø 60mm X 0.7m OF07				+	+			
Extraction arm Ø 60 mm X 1.0 m OF10	+	+				+	+	+
Extraction arm Ø 32mm X 1.0m T0053658099			+					
Stop valve w/ brackets T0053657499	+	+	+	+	+	+	+	+
Extraction hose Ø 60mm x 3m 700-3051-ESD	+	+	+	+	+	+	+	+
Adapter w/ O-rings 50mm to 60mm T0058762753	+					+		

*Kit 2 ALFA Funnel Nozzle contains 2 of everything in Kit 1 above. Order No. 100-120 V T0053664299

Extraction arms from Weller®FT feature very low pressure drop and are excellent for connecting to central ventilation systems.

The diagram below shows the pressure drop in some of the standard arms.

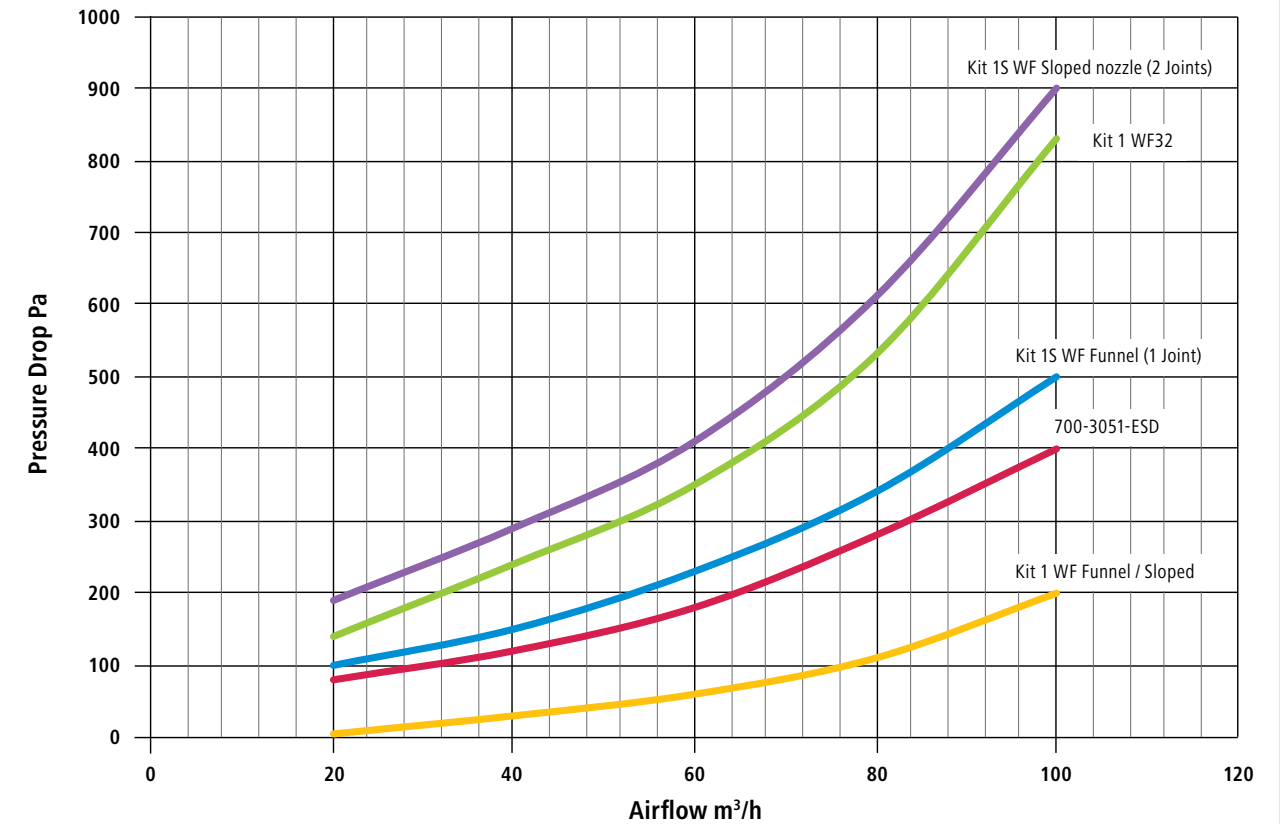
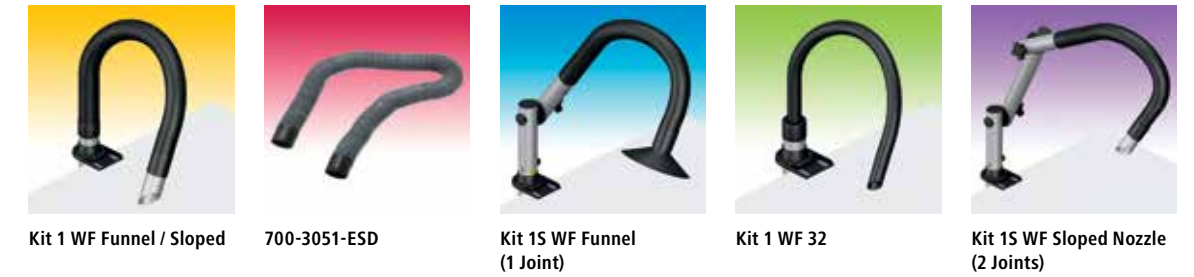

> With funnel nozzle



Kit 1 ALFA Funnel Nozzle



Order No.	Description
T0053657199	Easy-Click-60 extraction arm with funnel, width 230 mm, height 100 mm, flexible arm, Ø 60 mm, length 1 m, with stop valve
Consists of:	
T0053657499	Stop valve with bench mounting brackets
700-3051-ESD	Extraction hose, flexible, 3 m, Ø 60 mm
OF10	Extraction arm Ø 60 mm, 1 m
ALFA	Funnel nozzle

> With sloped nozzle



Kit 1 Sloped Nozzle



Order No.	Description
T0053657299	Easy-Click-60 extraction arm with sloped nozzle, Ø 60 mm, length 1 m, stop valve
Consists of:	
T0053657499	Stop valve with bench mounting brackets
700-3051-ESD	Extraction hose, flexible, 3 m, Ø 60 mm
OF10	Extraction arm Ø 60 mm, 1 m
FT-NL	Sloped nozzle

> Extraction arm for applications with limited space, such as under a microscope



Kit 1 32 Sloped Nozzle



Order No.	Description
T0058762770	Easy-Click-60 extraction arm with sloped nozzle Ø 60 mm, length 1 m, Ø 32 mm, stop valve
Consists of:	
T0053657499	Stop valve with bench mounting brackets
700-3051-ESD	Extraction hose, flexible, 3 m, Ø 60 mm
T0053658099	Extraction arm Ø 32 mm, 1 m
T0058762834	Sloped Nozzle

> 2 joint arm and sloped nozzle



Kit 1S Sloped Nozzle



Order No.	Description
T0053657999	Easy-Click-60 2 joint aluminium extraction arm with sloped nozzle, stop valve, length 1.5 m
Consists of:	
T0053659899	2 joint arms with stop valve and bench mounting brackets
700-3051-ESD	Extraction hose, flexible, 3 m, Ø 60 mm
OF07	Flex. extraction arm Ø 60 mm, 0.7 m
FT-NL	Sloped nozzle

> 1 joint arm and funnel nozzle



Kit 1S Funnel Nozzle



Order No.	Description
T0058762763	Easy-Click-60 1 joint aluminium extraction arm with funnel nozzle, stop valve, length 1.14 m
Consists of:	
T0058762747	1 joint arm with stop valve and bench mounting brackets
700-3051-ESD	Extraction hose, flexible, 3 m, Ø 60 mm
OF07	Flex. extraction arm Ø 60 mm, 0.7 m
ALFA	Funnel nozzle

Extraction Arm Nozzles



Order No.	Description
ALFA	Easy-Click-60 funnel nozzle* 225 mm x 100 mm
ALFA-T	Easy-Click-60 transparent funnel nozzle* 225 mm x 100 mm



* To be mounted on an aluminium extraction arm without flexible hose, Adapter Z is needed.
See Extraction Arms Accessories next page.



WF32 Extraction Arm



Order No.	Description
T0053658099	ESD microscope extraction arm, flexible, Ø 32 mm, aluminium nozzle sloped 45°, length 1 m



Flexible Extraction Arm, Ø 60 mm



Order No.	Description
0F07	Flexible, adjustable arm, length 0.7 m incl. connection (female) in both ends
0F10	Flexible, adjustable arm, length 1.0 m includes connection (female) in both ends
0F15	Flexible, adjustable arm, length 1.5 m includes connection (female) in both ends





Extraction Arm Accessories

Order No.	Description
FT-NL	Easy-Click-60 metal sloped nozzle* Ø 60 mm, length 130 mm
T0058762834	Metal sloped nozzle 32 for 32 mm flex arms, Ø 31 mm, length 100 mm
FT-U	Easy-Click-60 nozzle* width 190 mm, length 100 mm
T0058735845	Metal exhaust hood 200 x 100 mm (7.87 x 3.93 in), recommended for use with hot air soldering operations incl. adapter T005 87 627 53
Z	Adapter to mount nozzles on aluminium arm with ability to turn the nozzle



Accessories



Order No.	Description	
T0058762767	Easy-Click-60 hose connector male, straight for WFE 2S, WFE 4S, ZS 4V, ZS 6V and pre-filter box	
T0058762769	Easy-Click-60 hose connector male, angle 90° for WFE 2S, WFE 4S, ZS 4V, ZS 6V and pre-filter box	
T0058762755	Easy-Click-60 male adapter for hose extension, Ø 60 mm	
T0058762772	Easy-Click-60 female adapter	
T0058762773	Easy-Click-60 male adapter 90°	
T0058762768	Easy-Click-60 hose connection female 60 mm for flexible hose T005 87 620 36	





Extraction hose



Order No.	Description
7003040-ESD	Easy-Click-60 extraction hose, Ø 60 mm include quick connections, length 1 m
7003051-ESD	Easy-Click-60 extraction hose, Ø 60 mm include quick connections, length 3 m

Accessories



Order No.	Description	
T0058762766	Easy-Click-60 T-piece with 2 male connections and 1 female connection	
T0058762774	Easy-Click-60 end cap female, 60 mm, click connection	
T0058762753	50/60 Adapter with silicone O-ring to connect Easy-Click 60 mm hoses to WFE 2ES, WFE 2CS, WFE 2S, MP or MG units or 50 mm tubes	

Accessories installation volume extraction



Order No.	Description
T00536574 99	Easy-Click-60 Stop valve Table connector for 60 mm (2.36 in) flex arm and extraction tube including air flow valve and 2 bench mounting brackets, male / male
T00536575 99	Bench mounting brackets, 2 x Maximum width of clamp 100 mm (3.93 in), Ø 100 mm (3.93 in), metal
T0058762765	Easy-Click WFV 60 Stop valve male/female for extraction arms without valve
T0058762808	Replacement butterfly valve plate for stop valve



ESD safe



Exhaust accessories move waste air out of a building

Order No.	Description
T0058735840	Exhaust adapter of pipe 100 to fume extraction unit WFE4S, ZS6V
T0058735915	Exhaust adapter of pipe 75 for fume extraction unit WFE2S, ZS4V

Remote control for tip and volume extraction units



Order No.	Description
T0058735909	Remote control for fume extraction units WFE20D, WFE2S, WFE4S, WFE8S, ZS4V, ZS6V. Switching unit on/off, speed setting (only WFE2S, WFE4S, ZS4V, ZS6V) filter status display.
T0053119199	Interface cable RS 232 , 2 m (78.74 in) for remote control (T0058735909)
700-3057	Remote control with cable for MG unit and WFE 2X
T0058762724 T0058764712	Adapter remote control for ZS4V, ZS6V WX adapter for ZS4V, ZS6V
T0058764710	Cable adapter cord for WX adapter (T0058764712)

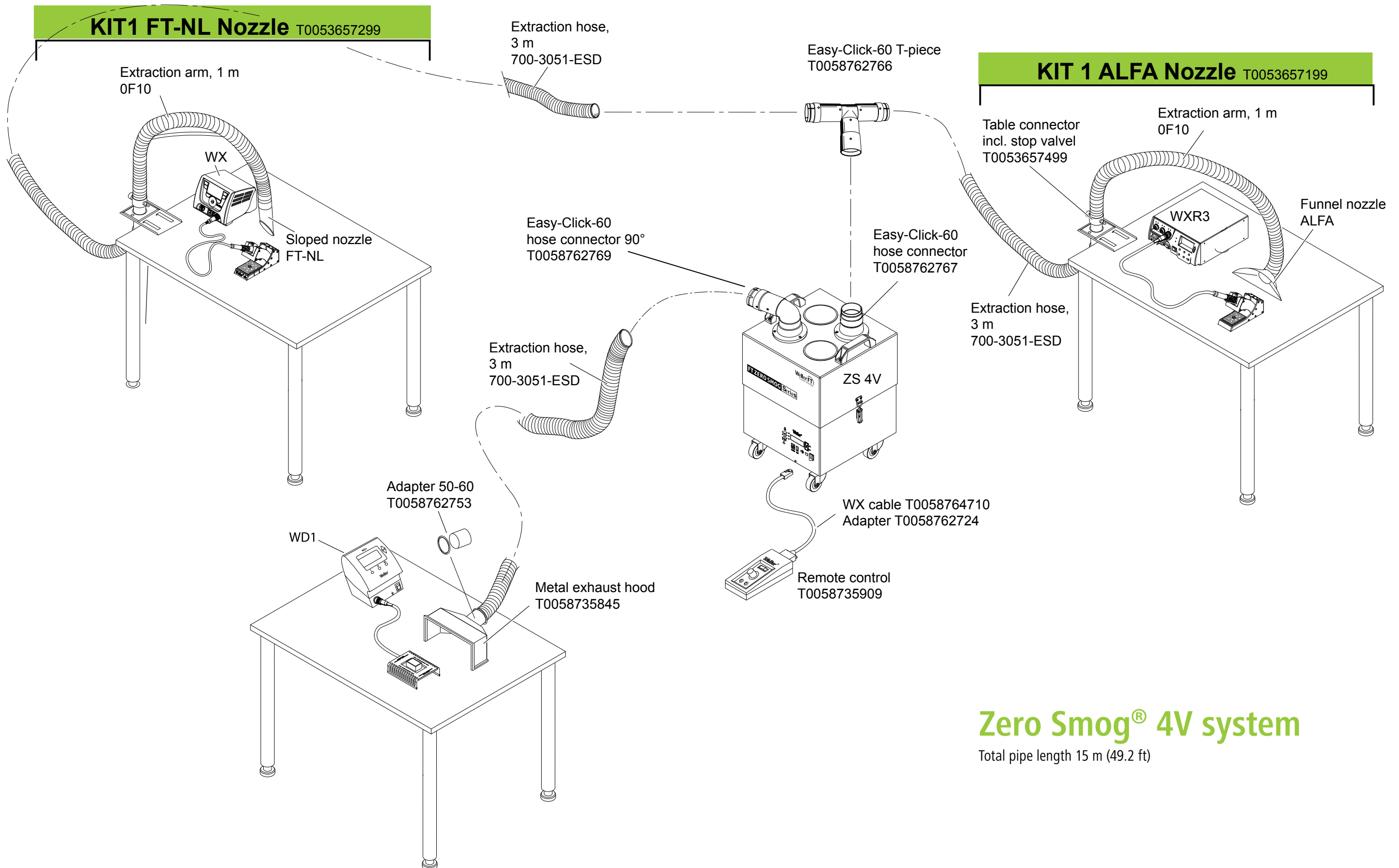

Zero Smog® 4V system

Total pipe length 15 m (49.2 ft)

Zero Smog® 6V system

Total pipe length 30 m (98.4 ft)

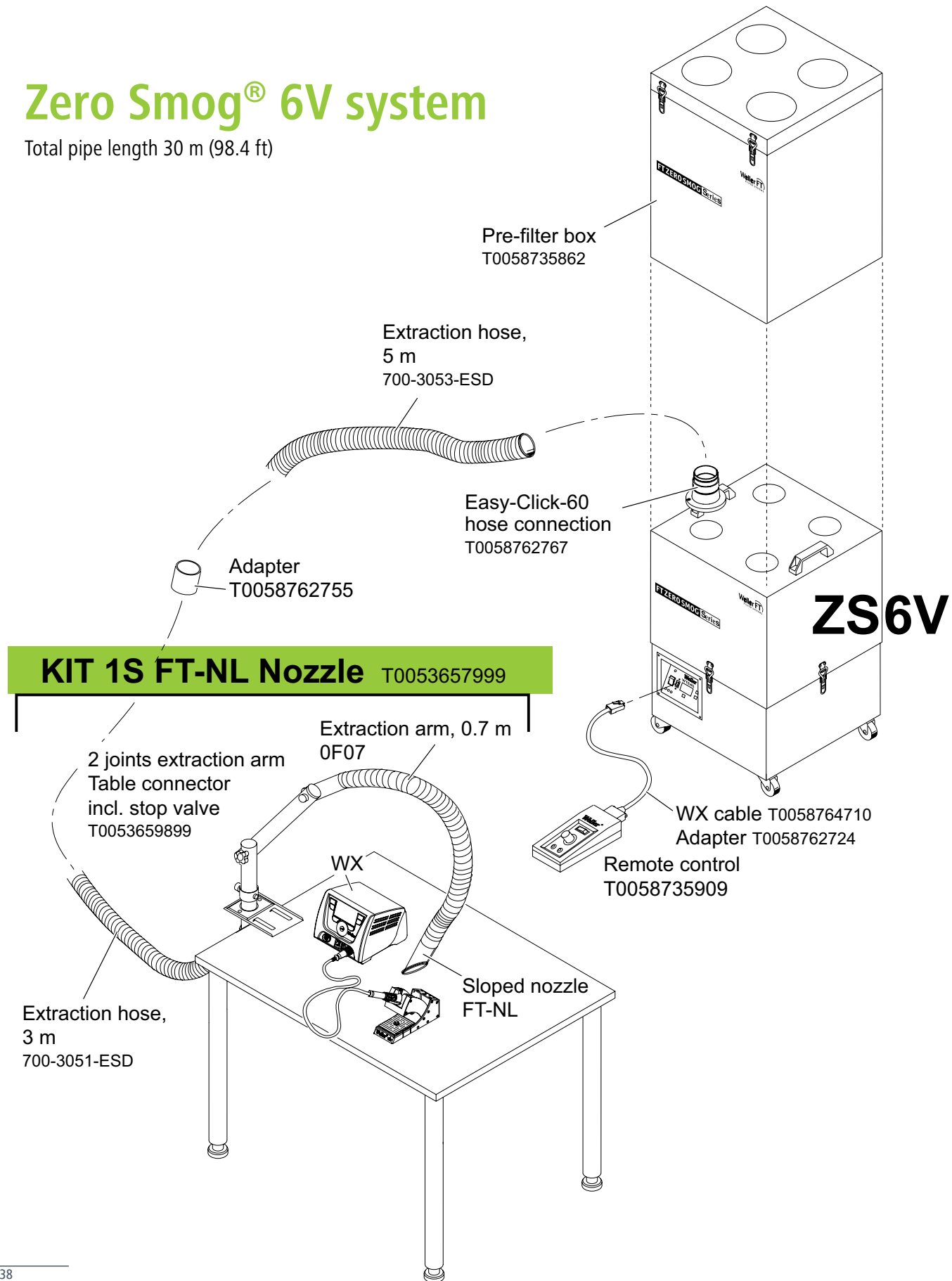

KIT 1S ALFA Nozzle

T0058762763

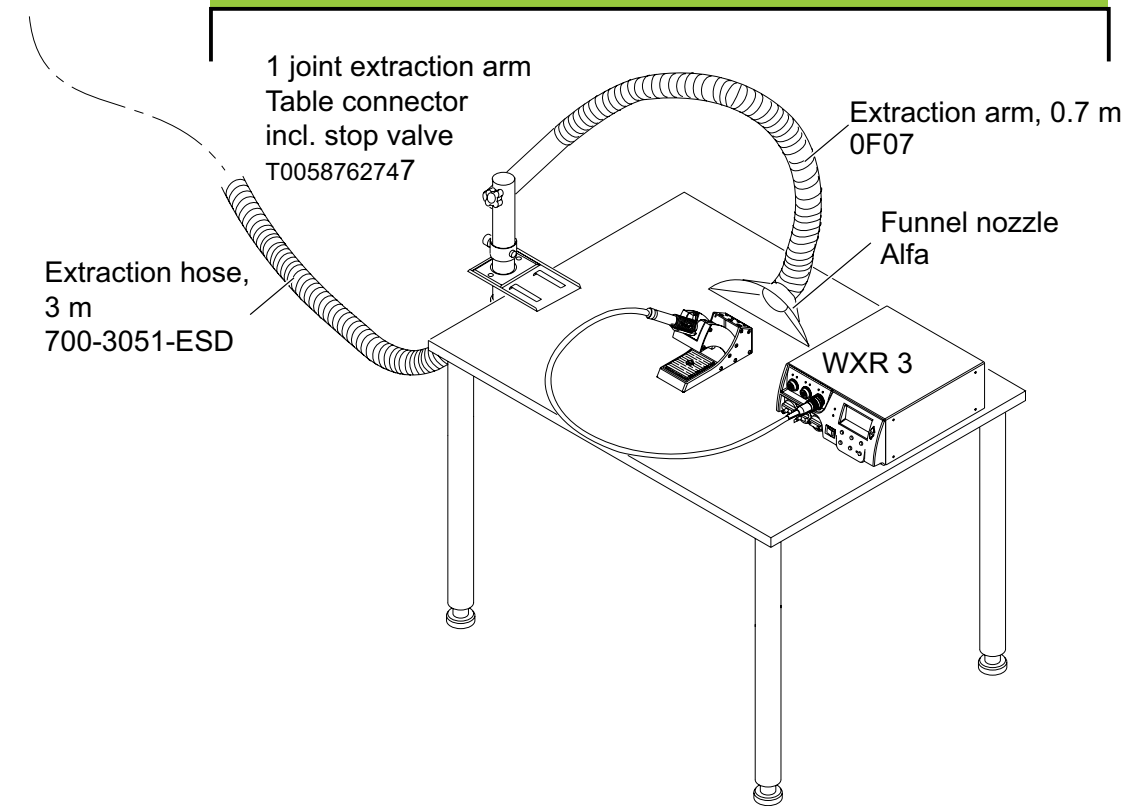

KIT 1 FT-NL Nozzle

T0053657299

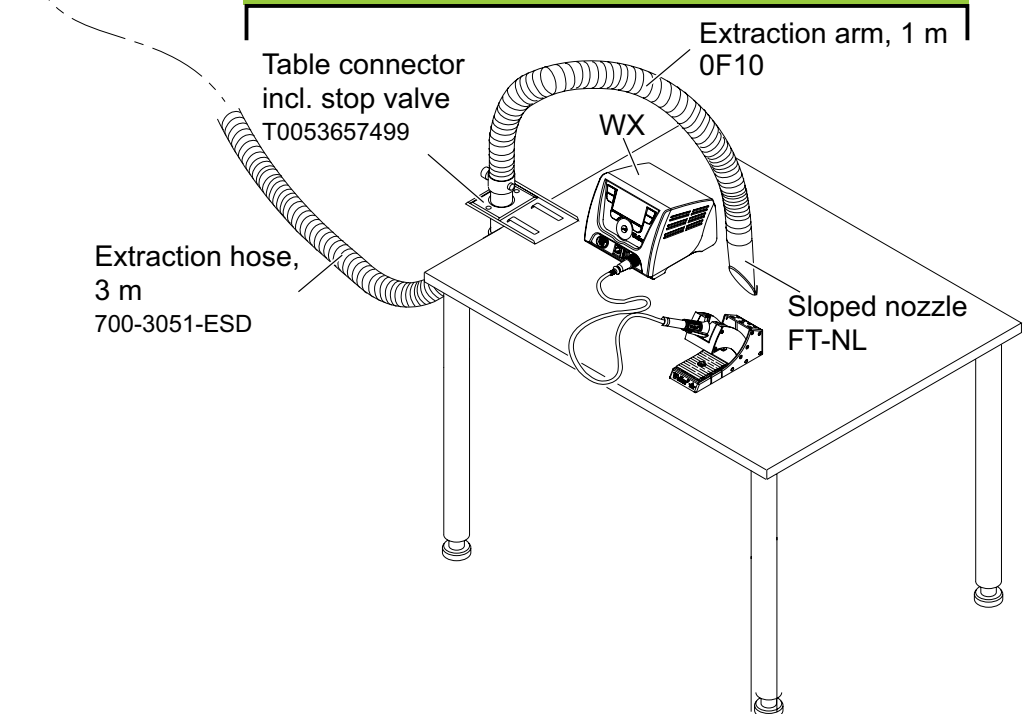

WEHT Extraction Hood Top

What's included:

WEHT Extraction hood, top source
 > 700-3051-ESD Extraction Hose Easy-Click 60, 3 m

Order No. **FT91000022**

Technical Data

Housing	PET not ESD safe
Dimensions (L x W x H)	860 x 510 x 460 mm 33.8 x 20.0 x 18.1 in



Extraction Hood Top Source

Weller®FT WEHT top source extraction hood for applications where fumes spread rapidly due to a drafty work environment. The hood can enclose the source, enabling fumes to be captured before they contaminate the workplace.



Extraction Hood Bottom Source

Weller® WEHB bottom source extraction hood for gluing or cleaning applications where gases from solvents or glue, lighter than air have to be extracted from below. The workplace is covered with a punched stainless steel plate.

WEHB Extraction Hood Bottom

What's included:

WEHB Extraction hood, bottom source
 > 700-3051-ESD Extraction Hose Easy-Click 60, 3 m

Order No. **FT91000023**

Technical Data

Housing	PET not ESD safe
Dimensions (L x W x H)	860 x 510 x 460 mm 33.8 x 20.0 x 18.1 in

Applications:

- > Soldering
- > Gluing, cleaning, filling
- > Laboratories



The air curtain cabinet CBC-A has a unique ventilation concept that separates the operator from the process by a dual air curtain system, giving unlimited accessibility on the workbench. It stands directly on the workbench and is easily connected to a FT mobile filter system or to central ventilation.

Technical Data

Height, int. / ext.	525 / 625 mm
Width, int. / ext.	1.120 / 1.275 mm
Depth, int. / ext.	580 / 760 mm
Weight	53 kg
Sound level	< 49 dB (A) at 1 m

For CBC-A112 G04, 2 pieces MG100S or one ZS6V extraction units with high gas filter volume are needed. Minimum extraction volume 180 m³/h, maximum 230 m³/h.

Order No.	Description
CBCA112G04G65I2115	Model CBC-A-112, 120 V version, G04 Top Cover



To guarantee sufficient extraction results an extraction unit with minimum 230 m³/h must be connected to the hoods (Weller®FT Zero Smog®4V).

Extract noxious fumes right at the source with Weller[®]FT tip extraction!

Weller[®] FE (Fume Extraction) soldering irons have a smoke tube adapted to the handle. When soldering the tube is positioned directly above the tip and collects any fumes produced. Fume extraction irons can be connected to the Weller[®]FT WFE2P system.



Characteristics

- > FE (Fume Extraction) soldering irons extract fumes directly at the soldering tip.
- > Less airflow and high vacuum, up to 30,000 Pa for efficient fume extraction.



WFE2P

Small, portable, electrically-driven fume extraction unit

Application

- > Hand soldering



H13 particle filter and wide band gas filter

F7 fine dust pre-filter

Technical Data

Maximum capacity	2 FE soldering irons
Noise level	< 45 db (A) at 1 m distance
Operating voltage	120 V / 60 Hz (USA)
Power input	70 W
Maximum vacuum	30,000 Pa
Height	295 mm
Diameter	140 mm
Weight	4 kg



Attributes

- > Up to 2 FE soldering irons can be connected
- > Electric vacuum pump produces the required vacuum
- > Portable unit for stand-alone applications
- > Small footprint on workplace

The Weller[®] WFE2P is a line voltage fume extraction unit designed to run with one or two FE (Fume Extraction) soldering irons.

The filter lift system allows fast and convenient main filter replacement.

FE soldering irons are connected directly to the unit.

*Note: Do not use for 24-hour continuous operation.

What's included:

- > FT Fume extraction unit
- > Compact filter consists of: H13 particle filter and wide band gas filter (50% active carbon, 50% Chemisorb)
- > Fine dust filter F7

Order No. 120 V, WFE2P

T0053623299



Universal FE attachments



Order No.	Description
T0052918699	FE attachment with tube Ø 6.5 mm for WSP80, WP80, WP65, WP120



T0052918599	FE attachment with tube Ø 4.5 mm for WMRP and WSP80, WP80, WMP, for fine soldering applications
-------------	-----------------------------------------------------------------------------------------------------------



T0058744875	FE Clip Set for FE attachment, tube Ø 4.5 mm
-------------	-----------------------------------------------------



T0058744876	FE Clip Set for FE attachment, tube Ø 6.0 mm
-------------	-----------------------------------------------------



T0058765798	FE attachment with tube Ø 6.5 mm, WXP120
-------------	-------------------------------------------------



T0058765799	FE attachment with tube Ø 6.5 mm, WXP65
-------------	------------------------------------------------



Safety rests for FE75 series irons with the WFE2P

Weller safety rests are recommended accessories for FE irons using the WFE2P extraction units.



Order No.	Description
T0051515299	WDH30 Safety rest For FE75 fume extraction irons

Accessory for WFE2P



Order No.	Description
T0058735050	End cap to close off to connection nipple 5 mm

FE (Fume Extraction) Soldering Irons

The FE 75 smoke absorption tube is integrated into the handle. It can be placed over the joint when soldering but can be retracted when access to the joint is a problem and can also be removed for cleaning. FE 75 iron is temperature controlled, ergonomic and allow precise handling.



Order No.	Description
T0052916699	FE 75 Soldering iron set 80W / 24V with safety rest WDH30 for use with LT tips
T0051312599	FE attachment for DS22, DS80 and DSX80 desoldering iron



Table top solution with WFE2P

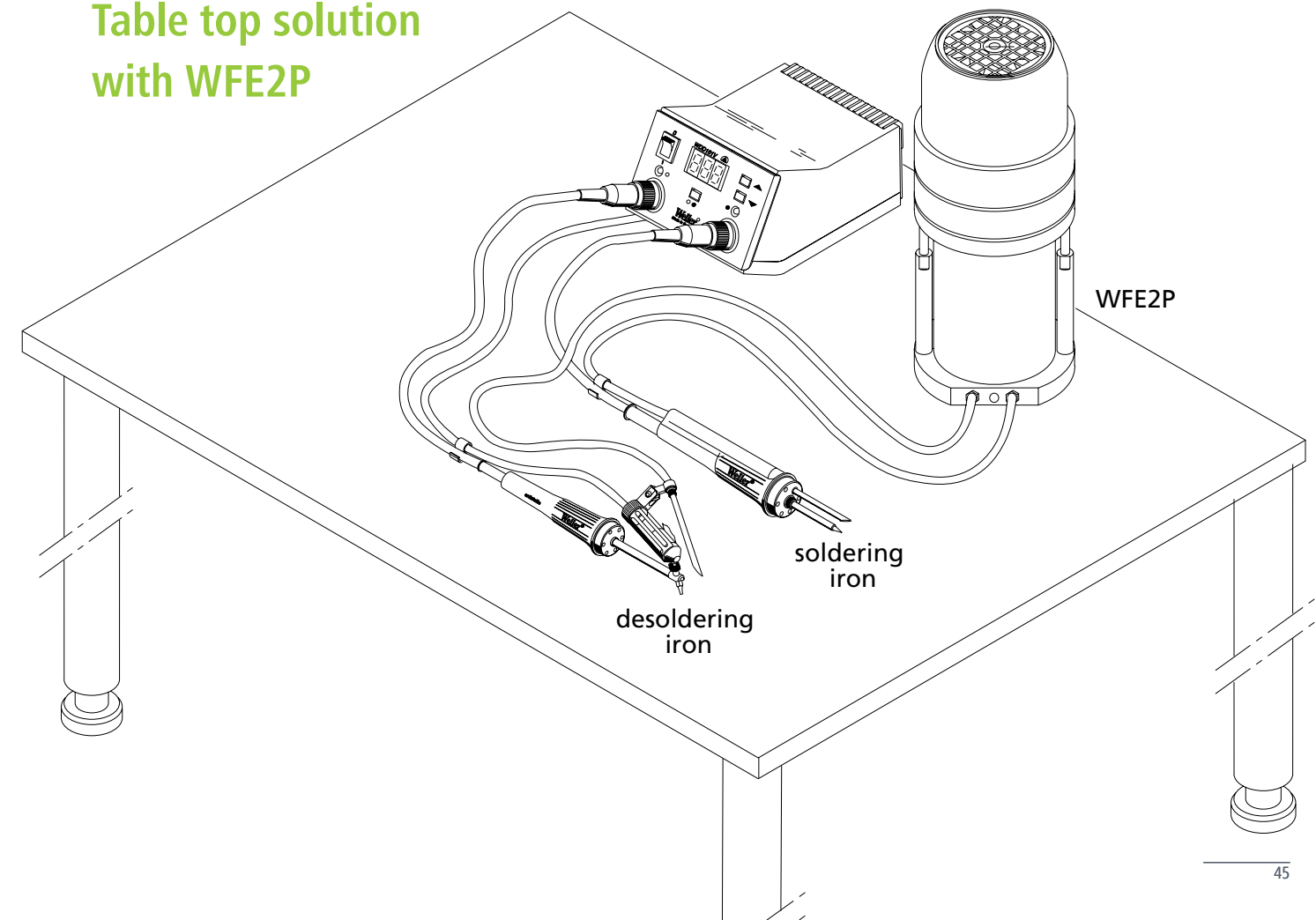



		Model Number Order Number	ZS2 ZEROSMOG2	MG100S U-100-1000-ESD	MG130 U-130-1055-ESD	MG140 U-145-1000-ESD	MG140 CLEANROOM U-145-1002-ESD	ZS4V T0053660299	ZS4V w/GAS T0053661299	ZS6V T0053666299	ZS6V w/GAS T0053667299	WFE2P T0053623299	Prefilter Box PF-1000	Prefilter Box T0058735862	CBC-A CBCA112G- 04G65I2115		
PRE-FILTERS	M5	T0058735837								++							
		T0058735937						++									
		T0058762703	++														
	F7	T0058735836								+	+						
		T0058735938						+	+								
		145-4000				+	+										
		130-2010			+												
		500-4000											+				
		T0058735860													++		
		T0058735924													++		
T0053642199											+						
COMPACT FILTERS	E12 GAS	T0058762701 SET WITH GAS FILTER	+														
		T0058735838								+	++						
	H13 GAS	T0058735936						+	++								
		100-2000-ESD		+													
		145-2000-ESD				+	++										
		130-2000-ESD			+												
		T0053641099										+					
		F01														+	
		W/SPECIALTY FILTERS	145-2003-ESD MEK				++										
			100-2003-ESD MEK		++												
			145-2002-ESD CLEAN ROOM				++	+									
			100-2002-ESD CLEAN ROOM		++												
			145-2012-ESD SOLVENTS / VOC				++										
100-2012-ESD SOLVENTS / VOC		++															
GAS	GAS	T0053640799 ADHESIVE										++					
		T0058735835								++	+						
		T0058735895	++						++	+							



		WFE2ES	WFE2S	WFE2X	WFE4S	WFE8S	WFE20D
PRE-FILTERS	M5	T0058735837			++		
		T0058735937		++			
		T0058762703	++				
	F7	T0058735836				+	
		T0058735938		+			+
		T0053659499					+
COMPACT FILTERS	E12 GAS	T0058762701 SET WITH GAS FILTER	+				
		T0058735838			+		+
	H13 GAS	T0058735936		+			
		T0053659599					+
		100-2000-ESD			+		
		100-2003-ESD MEK				++	
		100-2002-ESD CLEAN ROOM				++	
W/SPECIALTY FILTERS	100-2012-ESD SOLVENTS / VOC				++		
GAS	GAS	T0058735835				++	
		T0058735895	++	++			

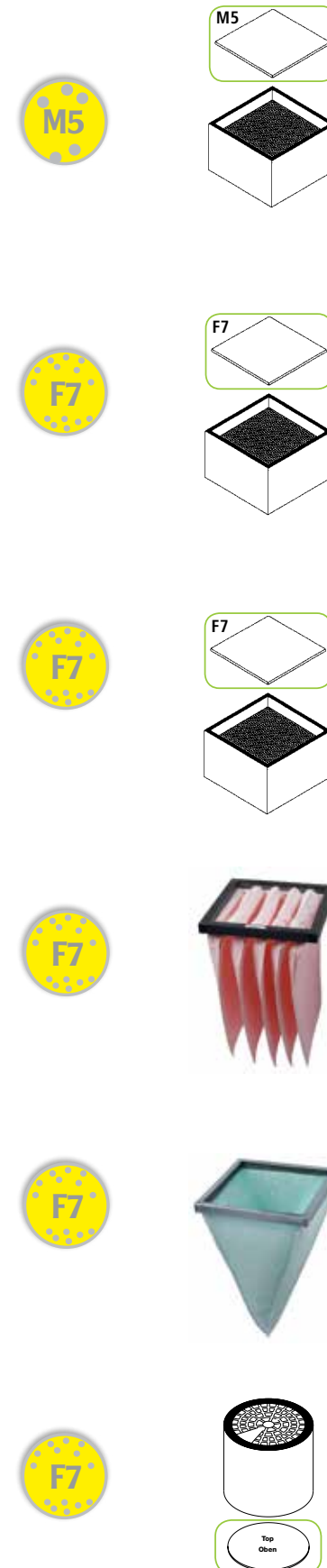

Order No.	Description
T0058735837	Medium dust filter M5 for WFE20D, ZS6V / WFE4S, 10 pcs
T0058735937	Medium dust filter M5 for WFE2S, ZS4V, 10 pcs
T0058762703	Medium dust filter M5 for WFE2ES, 10 pcs

Order No.	Description
T0058735836	Fine dust filter F7 for WFE20D, ZS6V / WFE4S, 10 pcs
T0058735938	Fine dust filter F7 for WFE2S and ZS4V, 10 pcs
T0053659499	Fine dust filter F7 for WFE8S

Order No.	Description
145-4000	Pre-filter MG140 / F7 (2 pcs)
130-2010	Pre-filter MG130 / F7 (5 pcs)

Order No.	Description
T0058735860	Pocket filter F7 for applications with a high fine dust rate, for pre-filter box T0058735862

Order No.	Description
T0058735924	Pocket filter for filtering fine dust for sticky particles (e.g. large quantities of liquid flux) for pre-filter box T0058735862

Order No.	Description
T0053642199	Fine dust filter F7 (3 pcs) for WFE2P

Easy to replace filters!



How to change a Weller®FT filter?
See the movie on www.youtube.com/wellersoldering



E12

Order No.	Description
140-2000-ESD	Particle filter E12 for MG140

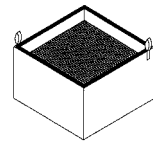

Order No.	Description
T0058762701	Filter set: WFE2ES with E12 particle filter and ten M5 prefilters (gas filter – 10% active carbon foam filter) for WFE2ES and ZS2V

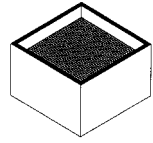

Order No.	Description
T0058735838	H13 particle filter and wide band gas filter (50% active carbon, 50% Chemisorb) for WFE4S / WFE20D / ZS6V
T0058735936	H13 particle filter for WFE2S, ZS4V

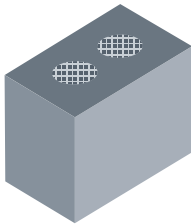

Order No.	Description
100-2000-ESD	H13 particle filter and wide band gas filter (50% active carbon, 50% Chemisorb) for MG100S and WFE2X
100-2003-ESD	H13 particle filter and MEK gas filter MG100S and WFE2X
100-2012-ESD	H13 particle filter and solvents / VOC gas filter MG100S and WFE2X
100-2002-ESD	H13 particle filter and cleanroom gas filter MG100S and WFE2X

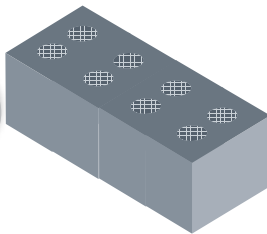

Order No.	Description
T0053659599	H13 particle filter and wide band gas filter (50% active carbon, 50% Chemisorb) for WFE8S

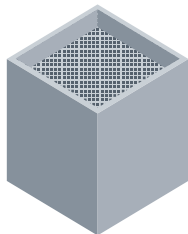

Order No.	Description
145-2000-ESD	H13 particle filter and wide band gas filter (50% active carbon, 50% Chemisorb) for MG140
145-2002-ESD	H13 particle filter and Cleanroom gas filter MG140
145-2012-ESD	H13 particle filter and solvents / VOC gas filter MG140
145-2003-ESD	H13 particle filter and MEK gas filter MG140

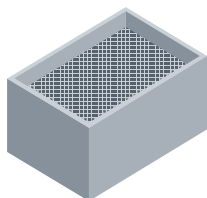

Order No.	Description
130-2000-ESD	H13 particle filter and wide band gas filter (50% active carbon, 50% Chemisorb) for MG130

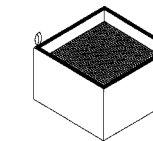
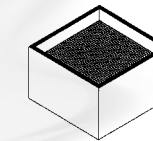
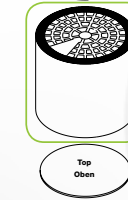

Order No.	Description
F01	Replacement filter CBC-A

Order No.	Description
T0053641099	H13 particle filter and wide band gas filter (50% active carbon / 50% Chemisorb) for WFE2P

Order No.	Description
T0053640799	Wide band gas filter for adhesive fumes (50% active carbon, 50% Chemisorb) for WFE2P

Order No.	Description
T0058735835	Wide band gas filter for adhesive fumes (50% active carbon, 50% Chemisorb) for ZS6V / WFE4S

Order No.	Description
T0058735895	Wide band gas filter for adhesive fumes (50% active carbon, 50% Chemisorb) for WFE2S, ZS4V, WFE2ES

Order No.	Description
T0058735757	Compressed air cleaning filter (active carbon) for WFE2P

Order No.	Description
PF-1000	Pre-filter box WFE2X / MG100S Delivered with brackets and 2m connection hose
500-4000	Pre-filter bags (5 pcs) for PF-1000

We're here to help!

1-(866)-498-0484

weller-na@weller-tools.com

weller-toolsus.com

