



**EZ-9000 Tape Dispenser, EZ-9000-RP Tape Dispenser**  
**Part Number 66135 / 66137**  
MAY 2012 REV 1.0



**PLEASE NOTE**

Some of the part numbers are now different depending on when the unit was manufactured. The drawing will note where the appearance is different and the parts list will give you the correct part based on the S/N of the unit.

See last page for the parts that are specific to the #66137 EZ-9000-RP

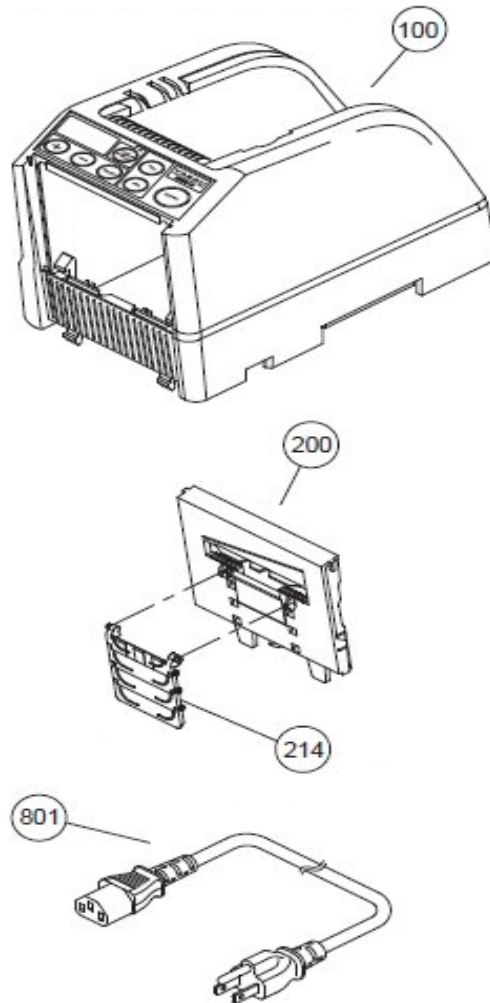



**EZ-9000 Tape Dispenser, EZ-9000-RP Tape Dispenser**  
**Part Number 66135 / 66137**  
 MAY 2012 REV 1.0

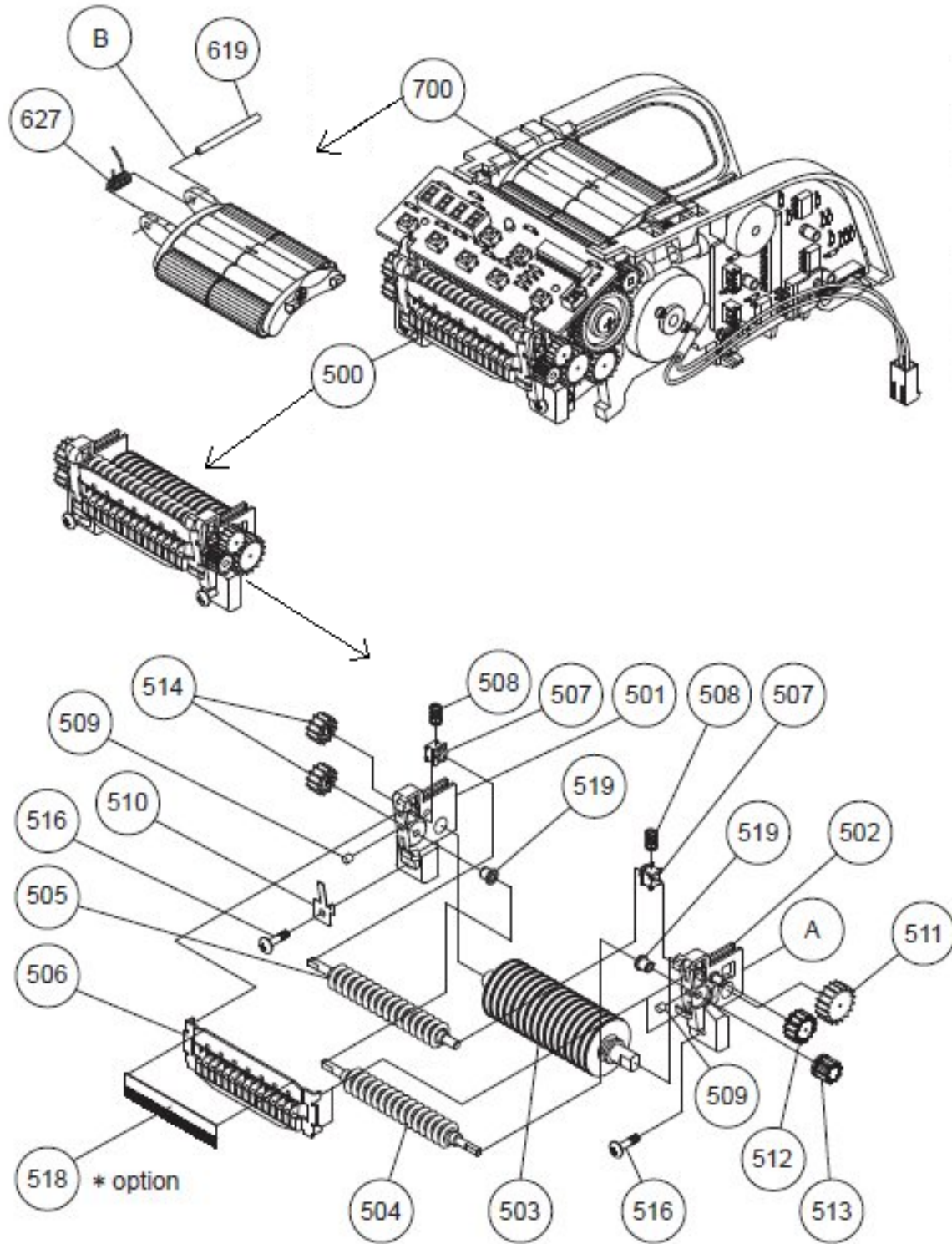

**ASG, Div Jergens Inc.**

Jergens Way | 15700 South Waterloo Road | Cleveland OH 44110

Tel (216) 486-6163 | Toll-Free (888) 486-6163 | Fax (216) 481-4519

E-mail: [asginfo@asg-jergens.com](mailto:asginfo@asg-jergens.com) | Web: [www.asg.jergens.com](http://www.asg.jergens.com) | [facebook.com/ASGJergens](https://facebook.com/ASGJergens)

**ISO 9001 : 2008**



**EZ-9000 Tape Dispenser, EZ-9000-RP Tape Dispenser**  
**Part Number 66135 / 66137**  
MAY 2012 REV 1.0

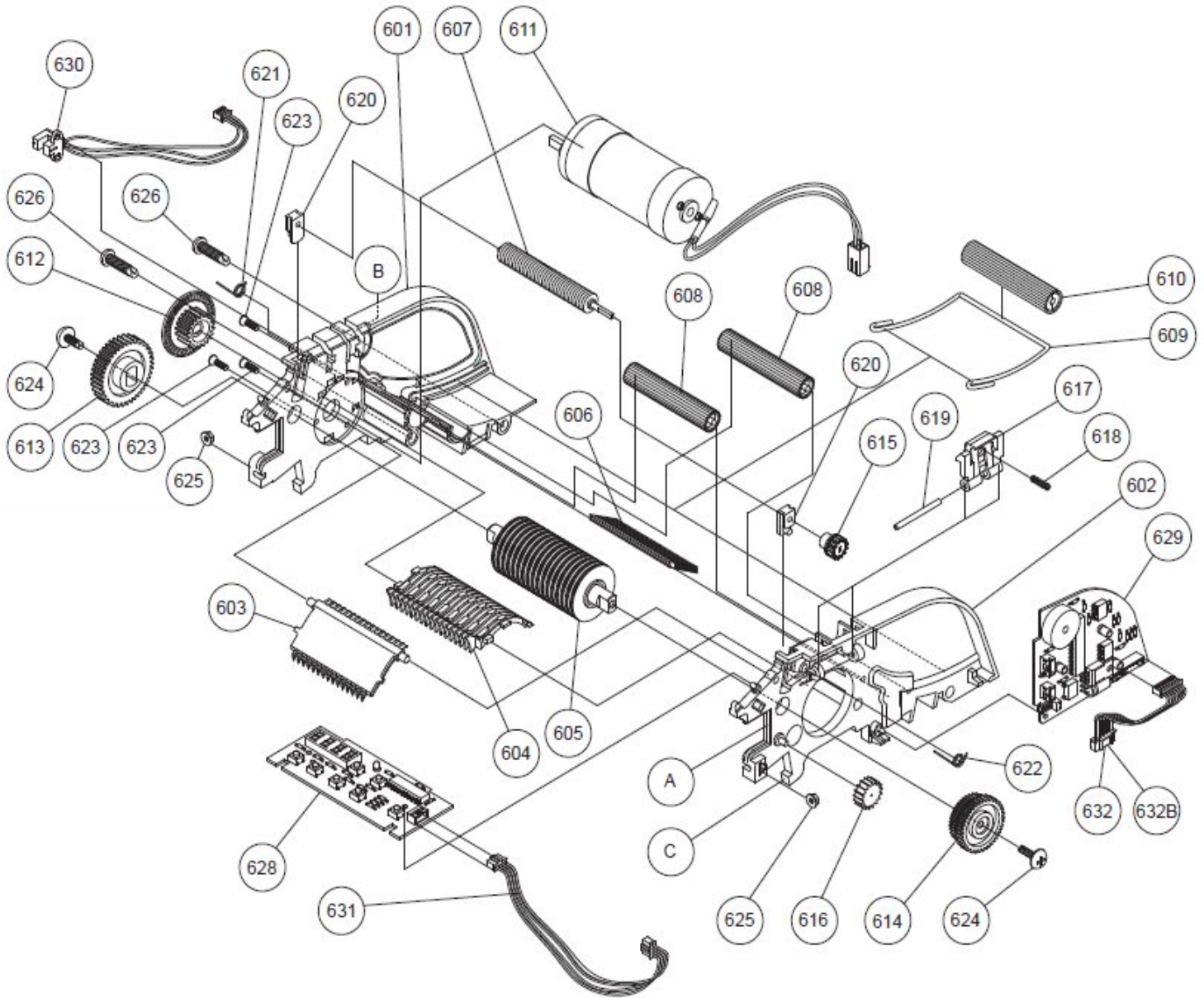

**ASG, Div Jergens Inc.**

Jergens Way | 15700 South Waterloo Road | Cleveland OH 44110

Tel (216) 486-6163 | Toll-Free (888) 486-6163 | Fax (216) 481-4519

E-mail: [asginfo@asg-jergens.com](mailto:asginfo@asg-jergens.com) | Web: [www.asg.jergens.com](http://www.asg.jergens.com) | [facebook.com/ASGJergens](https://facebook.com/ASGJergens)

**ISO 9001 : 2008**





**EZ-9000 Tape Dispenser, EZ-9000-RP Tape Dispenser**  
**Part Number 66135 / 66137**  
MAY 2012 REV 1.0



**STARTING S/N N0800001  
TO S/N N0800526**

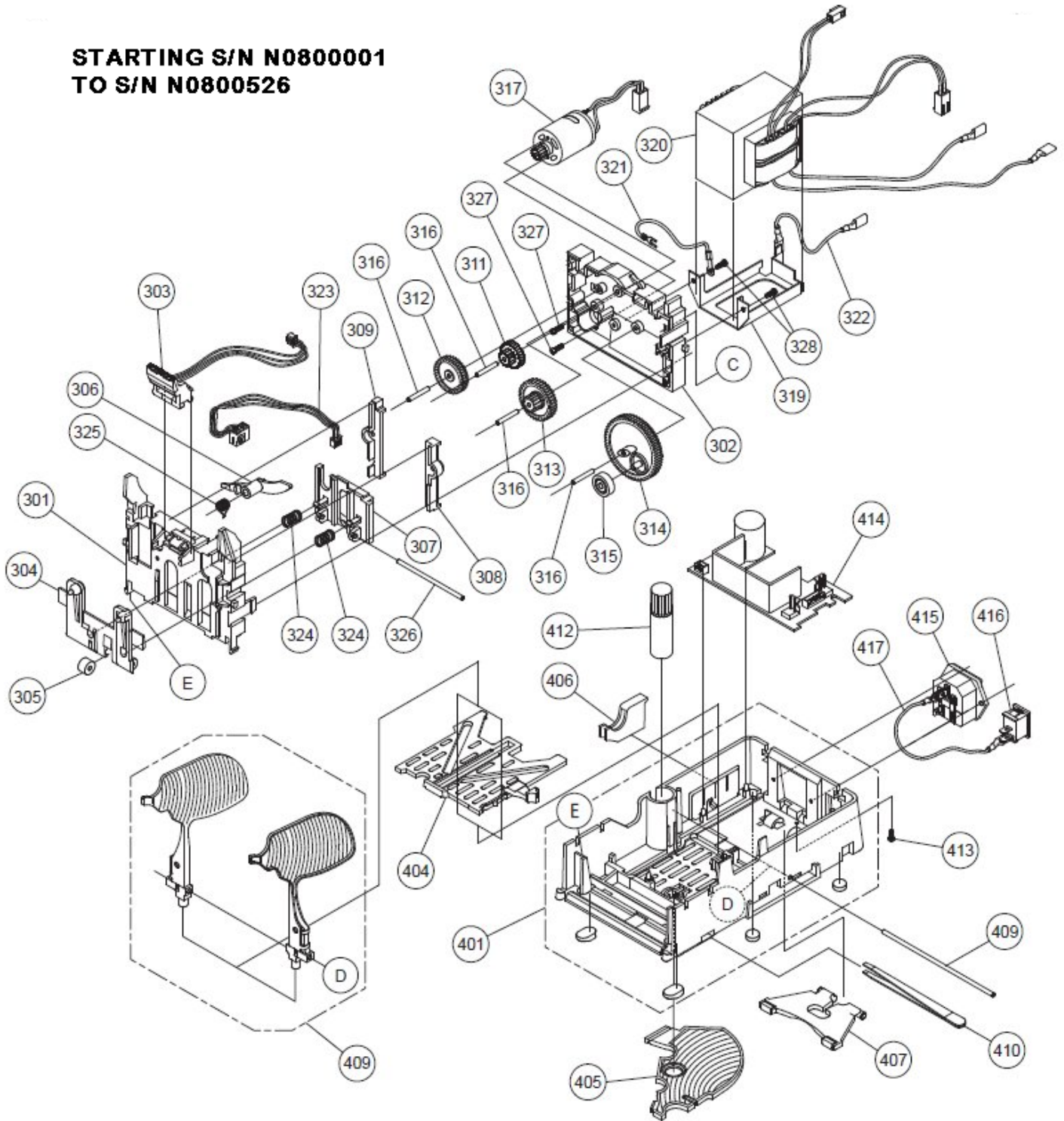

**ASG, Div Jergens Inc.**

Jergens Way | 15700 South Waterloo Road | Cleveland OH 44110

Tel (216) 486-6163 | Toll-Free (888) 486-6163 | Fax (216) 481-4519

E-mail: [asginfo@asg-jergens.com](mailto:asginfo@asg-jergens.com) | Web: [www.asg.jergens.com](http://www.asg.jergens.com) | [facebook.com/ASGJergens](https://facebook.com/ASGJergens)

**ISO 9001 : 2008**



**EZ-9000 Tape Dispenser, EZ-9000-RP Tape Dispenser**  
**Part Number 66135 / 66137**  
MAY 2012 REV 1.0



**Starting S/N N0800527  
and Above**

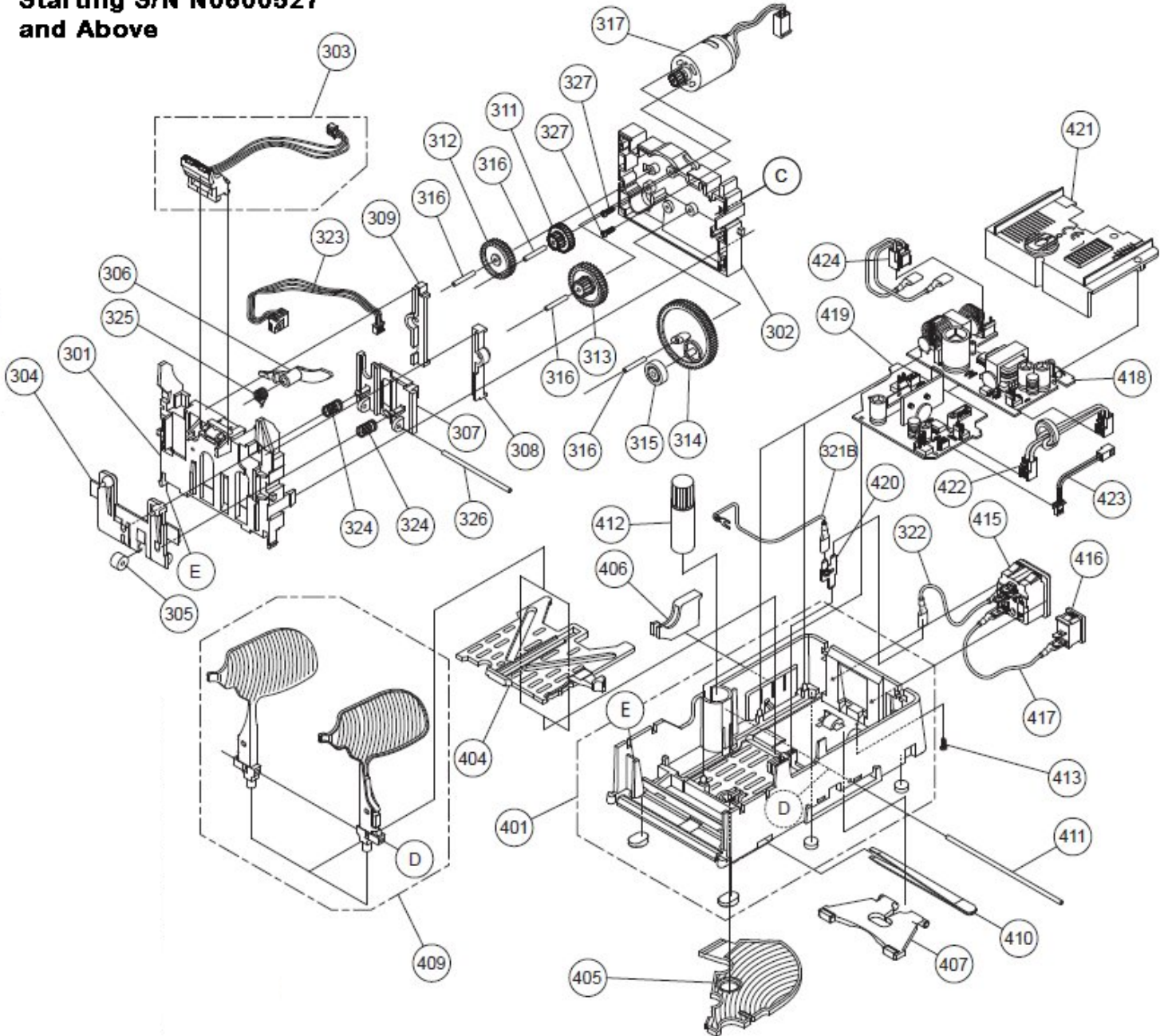

**ASG, Div Jergens Inc.**









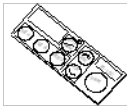

Jergens Way | 15700 South Waterloo Road | Cleveland OH 44110  
Tel (216) 486-6163 | Toll-Free (888) 486-6163 | Fax (216) 481-4519  
E-mail: [asginfo@asg-jergens.com](mailto:asginfo@asg-jergens.com) | Web: [www.asg.jergens.com](http://www.asg.jergens.com) | [facebook.com/ASGJergens](https://facebook.com/ASGJergens)

**ISO 9001 : 2008**

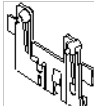

**EZ-9000 Tape Dispenser, EZ-9000-RP Tape Dispenser**  
**Part Number 66135 / 66137**  
 MAY 2012 REV 1.0

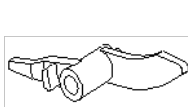
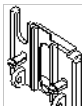

Ref.	Part #	Part Name	Figure	Notes
100	750000	BODY SET		
105	N/A	CONTROL PANEL		PART OF 100
200	750001	BLADE UNIT		
214	750002	FLEXIBLE TAPE SUPPORT		
301	750003	GEAR BOX FRONT		
302	750004	GEAR BOX REAR		
303	750005	TAPE SENSOR		
304	750006	SLIDE PLATE		
305	750007	PLATE ROLLER		
306	750008	SENSOR LEVER		
307	750009	BLADE PLATE		
308	750010	CAM FIX BAR (LEFT)		



**EZ-9000 Tape Dispenser, EZ-9000-RP Tape Dispenser**  
**Part Number 66135 / 66137**  
 MAY 2012 REV 1.0



Ref.	Part #	Part Name	Figure	Notes
309	750011	CAM FIX BAR (RIGHT)		
311	750012	BLADE GEAR #1		
312	750013	BLADE GEAR #2		
313	750014	BLADE GEAR #3		
314	750015	BLADE MAIN GEAR		
315	750016	BLADE GEAR BEARING		
316	750017	BLADE GEAR SHAFT		SET OF 4 PCS.
317	750018	BLADE MOTOR		
319	750019	TRANSFORMER BRACKET		
320	750020	TRANSFORMER		
321	750021	EARTH WIRE		To S/N N0800526
321B	750200	EARTH WIRE		S/N N0800527 & UP



**ASG, Div Jergens Inc.**

Jergens Way | 15700 South Waterloo Road | Cleveland OH 44110

Tel (216) 486-6163 | Toll-Free (888) 486-6163 | Fax (216) 481-4519

E-mail: [asginfo@asg-jergens.com](mailto:asginfo@asg-jergens.com) | Web: [www.asg.jergens.com](http://www.asg.jergens.com) | [facebook.com/ASGJergens](https://facebook.com/ASGJergens)











ISO 9001 : 2008

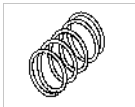

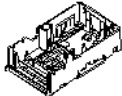

**EZ-9000 Tape Dispenser, EZ-9000-RP Tape Dispenser**  
**Part Number 66135 / 66137**  
 MAY 2012 REV 1.0

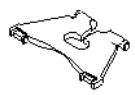









Ref.	Part #	Part Name	Figure	Notes
322	750022	INLET CABLE		
323	750023	BLADE SENSOR		
324	750024	COIL SPRING		SET OF 2 PCS.
325	750025	SPRING		
326	750026	PLATE SHAFT		
327	750027	SCREW M2.6 x 6L		SET OF 2 PCS.
328	750028	SCREW 3 x 8L		SET OF 2 PCS.
401	750029	BASE SET		
405	750030	SEPARATOR		
406	750031	GUIDE PLATE		
407	750032	SUPPORT STAND		
409	750033	TAPE HOLDER SET		SET ONLY

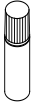

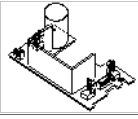
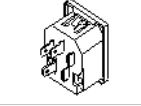
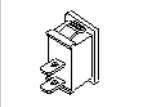

**EZ-9000 Tape Dispenser, EZ-9000-RP Tape Dispenser**  
**Part Number 66135 / 66137**  
 MAY 2012 REV 1.0

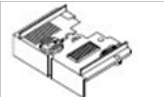







Ref.	Part #	Part Name	Figure	Notes
410	750034	TWEEZERS		
412	750035	SILICON OIL		
413	750036	SCREW M3 x 6L		
414	750037	P.C.B. (C)		
415	750038	INLET		
416	750039	POWER SWITCH		
417	750040	INLET CABLE		
418	750201	P.C.B. (D)		
419	750093	P.C.B. (E)		
420	750202	EARTH TERMINAL		
421	750203	P.C.B. COVER		
422	750204	JOINT CABLE 24V		

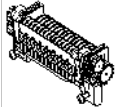
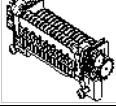
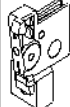

**EZ-9000 Tape Dispenser, EZ-9000-RP Tape Dispenser**  
**Part Number 66135 / 66137**  
 MAY 2012 REV 1.0

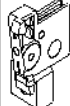
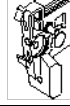
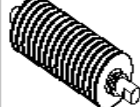

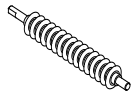







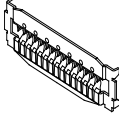

Ref.	Part #	Part Name	Figure	Notes
423	750205	JOINT CABLE 9V		
424	750206	INLET CABLE		
500	750041	REMOVABLE ROLLER SET		To S/N N0801076
500-1	750094	REMOVABLE ROLLER SET		From S/N N0801077
501	750042	FRONT FRAME RIGHT		To S/N N0801076
502	750043	FRONT FRAME LEFT		To S/N N0801076
501-1	750095	FRONT FRAME RIGHT		From S/N N0801077
502-1	750096	FRONT FRAME LEFT		From S/N N0801077
503	750044	ROLLER #3		
504	750045	ROLLER #5		
505	750046	ROLLER #4		To S/N N0801076
505-1	750059	ROLLER #4		From S/N N0801077

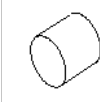

**EZ-9000 Tape Dispenser, EZ-9000-RP Tape Dispenser**  
**Part Number 66135 / 66137**  
 MAY 2012 REV 1.0



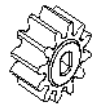
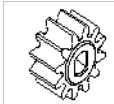







Ref.	Part #	Part Name	Figure	Notes
506	750047	TAPE OUTLET		
507	750048	ROLLER BUSHING		SET OF 2 PCS. TO S/N N0800744
507-1	750091	ROLLER BUSHING		SET OF 2 PCS. FROM S/N N0800745
508	750049	ROLLER SPRING		SET OF 2 PCS.
509	750050	MAGNET		SET OF 2 PCS.
510	750051	EARTH PLATE		
511	750052	M.R GEAR		TO S/N N0801076
511-1	750097	M.R GEAR		FROM S/N N0801077
512	750053	I. GEAR		
513	750054	R.D. GEAR		
514	750055	L.R. GEAR		
515	750056	U.R. GEAR		TO S/N N0800744

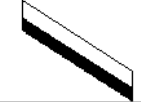

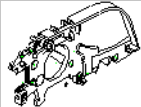
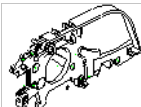
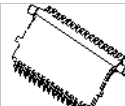
**EZ-9000 Tape Dispenser, EZ-9000-RP Tape Dispenser**  
**Part Number 66135 / 66137**  
 MAY 2012 REV 1.0

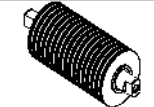

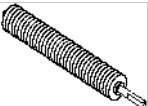
Ref.	Part #	Part Name	Figure	Notes
515-1	750092	U.R. GEAR		FROM S/N N0800745
516	750057	SCREW M3 x 11.3L		SET OF 2 PCS.
517	750058	WASHER		SET OF 2 PCS.
518	725991	ANTI-STATIC BRUSH		OPTIONAL PARTS SET OF 5 PCS.
601	750060	SIDE FRAME LEFT		
602	750061	SIDE FRAME RIGHT		TO S/N N0801076
602-1	750098	SIDE FRAME RIGHT		FROM S/N N0801077
603	750062	CHECK PLATE		
604	750063	MOTOR COVER		
605	750064	ROLLER #2		
606	750065	BRUSH		
607	750066	ROLLER #1		



**ASG, Div Jergens Inc.**

Jergens Way | 15700 South Waterloo Road | Cleveland OH 44110

Tel (216) 486-6163 | Toll-Free (888) 486-6163 | Fax (216) 481-4519

E-mail: [asginfo@asg-jergens.com](mailto:asginfo@asg-jergens.com) | Web: [www.asg.jergens.com](http://www.asg.jergens.com) | [facebook.com/ASGJergens](https://facebook.com/ASGJergens)









**ISO 9001 : 2008**

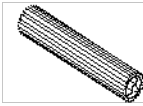
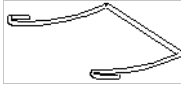
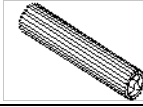



**EZ-9000 Tape Dispenser, EZ-9000-RP Tape Dispenser**  
**Part Number 66135 / 66137**  
 MAY 2012 REV 1.0

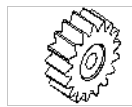
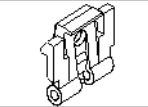

Ref.	Part #	Part Name	Figure	Notes
608	750067	TAPE SUPPORT ROLLER		SET OF 2 PCS.
609	750068	LOWER TAPE HOLDER		
610	N/A			PART OF 609
611	750069	MOTOR		
612	750070	ENCORDER		
613	750071	R. GEAR		
614	750072	D. GEAR		TO S/N N0801076
614-1	750099	D. GEAR		FROM S/N N0801077
615	750073	P.R. GEAR		
616	750074	I. GEAR		
617	750075	PLATE HANGER		
618	750076	HANGER SPRING		



**ASG, Div Jergens Inc.**

Jergens Way | 15700 South Waterloo Road | Cleveland OH 44110

Tel (216) 486-6163 | Toll-Free (888) 486-6163 | Fax (216) 481-4519









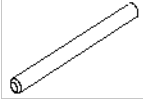
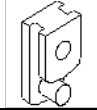

E-mail: [asginfo@asg-jergens.com](mailto:asginfo@asg-jergens.com) | Web: [www.asg.jergens.com](http://www.asg.jergens.com) | [facebook.com/ASGJergens](https://facebook.com/ASGJergens)

**ISO 9001 : 2008**

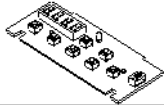

**EZ-9000 Tape Dispenser, EZ-9000-RP Tape Dispenser**  
**Part Number 66135 / 66137**  
 MAY 2012 REV 1.0



Ref.	Part #	Part Name	Figure	Notes
619	750077	Tape Guide Set Pin		SET OF 2 PCS.
620	750078	BUSHING		SET OF 2 PCS.
621	750079	SPRING LEFT		
622	750080	SPRING RIGHT		
623	750081	SCREW M3 x 6L		SET OF 3 PCS.
624	750082	SCREW M4 x 8L		SET OF 2 PCS.
625	750083	FRANGE NUT		SET OF 2 PCS.
626	750084	SCREW 4 x 12L		SET OF 2 PCS.
628	750085	P.C.B. (A)		
629	750086	P.C.B. (B)		
630	750087	LENGTH SENSOR		
631	750088	P.C.B. (A) CABLE		



**ASG, Div Jergens Inc.**

Jergens Way | 15700 South Waterloo Road | Cleveland OH 44110

Tel (216) 486-6163 | Toll-Free (888) 486-6163 | Fax (216) 481-4519



E-mail: [asginfo@asg-jergens.com](mailto:asginfo@asg-jergens.com) | Web: [www.asg.jergens.com](http://www.asg.jergens.com) | [facebook.com/ASGJergens](https://facebook.com/ASGJergens)

ISO 9001 : 2008



**EZ-9000 Tape Dispenser, EZ-9000-RP Tape Dispenser**  
**Part Number 66135 / 66137**  
MAY 2012 REV 1.0

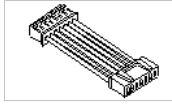
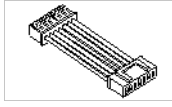
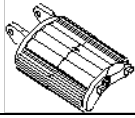

Ref.	Part #	Part Name	Figure	Notes
632	750089	P.C.B. (B) CABLE		TO S/N N0800526
632B	750089	P.C.B. (B) CABLE		FROM S/N N0800527
700	750090	HOLD DOWN ROLLER UNIT		
801	721997	POWER CORD		UL(120V)

**NOTE, the EZ-9000-RP is essentially a standard EZ-9000 bolted to the RP assembly. Part numbers available are ;**  
**725127 Bobbin assembly includes all plastic pieces. Individual parts not available separately.**  
**725123 Bracket, holds all of the bobbins and rollers**  
**725125 Base**



**ASG, Div Jergens Inc.**

Jergens Way | 15700 South Waterloo Road | Cleveland OH 44110

Tel (216) 486-6163 | Toll-Free (888) 486-6163 | Fax (216) 481-4519

E-mail: [asginfo@asg-jergens.com](mailto:asginfo@asg-jergens.com) | Web: [www.asg.jergens.com](http://www.asg.jergens.com) | [facebook.com/ASGJergens](https://facebook.com/ASGJergens)

**ISO 9001 : 2008**